



Booklet available in English on
Heft in deutscher Sprache erhältlich auf
Livret disponible en français sur
Libretto disponibile in Italiano su
Folleto disponible en español en
如需中文版手册, 请访问





BRINGING THE ICONIC SCENE TO LIFE THROUGH LEGO® BRICKS



CASPER GLAHDER: LEGO® GRAPHIC DESIGNER

ATTICUS TSAI MCCARTHY: LEGO® DESIGNER

WOON TZE CHEE: LEGO® SENIOR DESIGNER

"BOY, DO I HATE BEING RIGHT ALL THE TIME"

DR. IAN MALCOLM'S POMPOUS PREDICTIONS COME TRUE AS THE T. REX ESCAPES ITS PADDOCK.

"I love *Jurassic Park*! For me, it's the ultimate blockbuster and this job gave me the perfect excuse to rewatch it at least five times as part of the process... all in the name of research, of course! I'm especially proud of the shaping of the T. rex's head, and the use of the LEGO® Speed Champions windscreen as the canopy of the Ford Explorer. But, more specifically, there's a green plate I put inside the T. rex that references the genetic make-up of all the dinosaurs at Jurassic Park. It's a simple touch, but I like that it's there."

ATTICUS TSAI MCCARTHY: LEGO® DESIGNER





"DON'T. MOVE."

DR. ALAN GRANT OFFERS A (SLIGHTLY HOPEFUL) SOLUTION TO AVOID BEING EATEN.

This model is a collaboration between Atticus, a fellow LEGO® Designer, and me. Atticus focused on the main vehicle and the T. rex while I worked on the display base and the flipped car. We're both huge fans of the movie, so we know exactly what this scene means to people, which meant there was definitely some pressure to make it perfect!

One of the most exciting things about working on this set is the sheer number of famous details and iconic elements contained within it. From the shaking cups of water that first signify the arrival of the T. rex, that infuriating lamp (turn it off!), the burst tyres, the chain that held the (ill-fated) goat ... and that's not even to mention the magnificent creature itself! There's just so much going on, and that presents an interesting challenge for us, because we must keep everything in the right size and proportion in relation to the minifigures. Too much detail and things get very large, very quickly. Keep the object small and there may not be enough intricacy. In the end I think we found the right balance for the model to work as a scene while delivering a big hit of nostalgia. We hope our fellow *Jurassic Park* fans feel the same!

WOON TZE CHEE: LEGO® SENIOR DESIGNER

"RAAAWWKKKK!"

THE T. REX INTRODUCES HIMSELF TO A TERRIFIED TIM AND LEX MURPHY.

"It was my role to bring to life all the graphic elements within the set – particularly all the signs and stickers. It was a real honor to be able to work on the Ford Explorer, as it's the first time this has been brought to life in a LEGO® set and I know it's something fans have been calling for. I wanted to make it feel completely authentic and cover all those fun little details like the warning signs and the touchscreen inside the car. I'm also really pleased with how the T. rex's eyes came out, especially as they're such a memorable (and scary) part of the scene!"

CASPER GLAHDER: LEGO® GRAPHIC DESIGNER

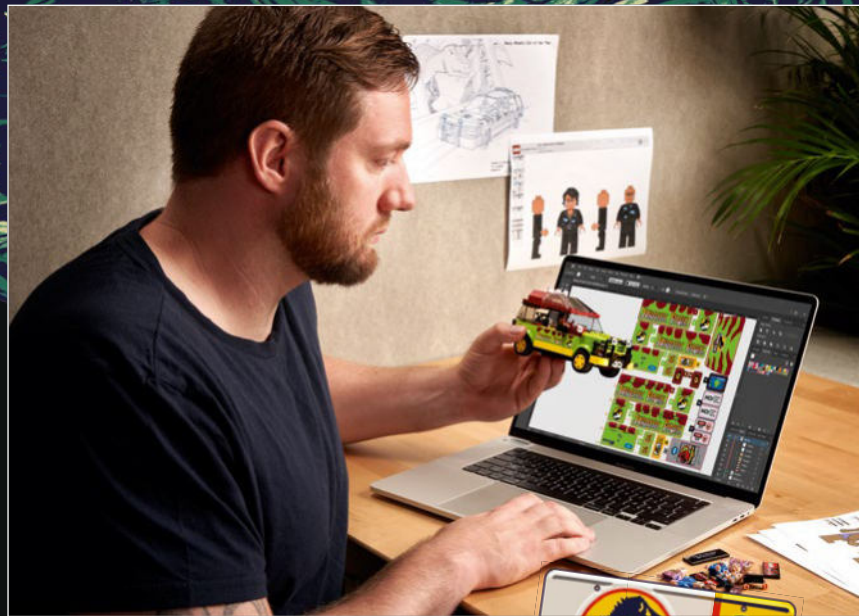

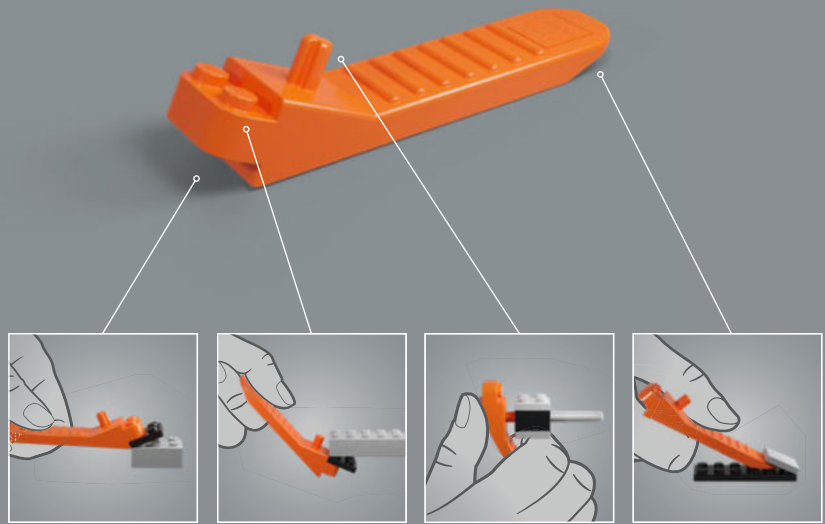

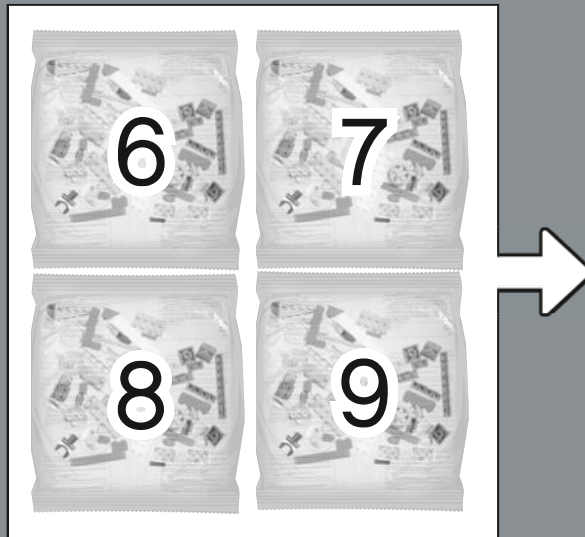
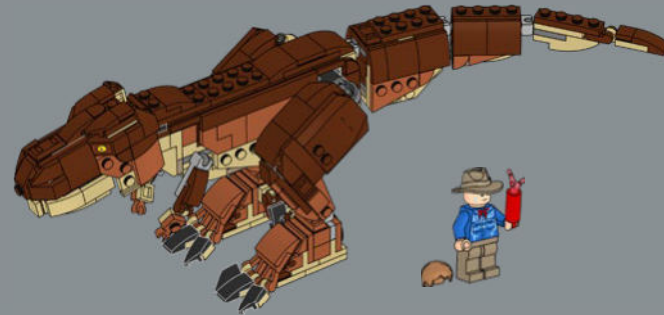

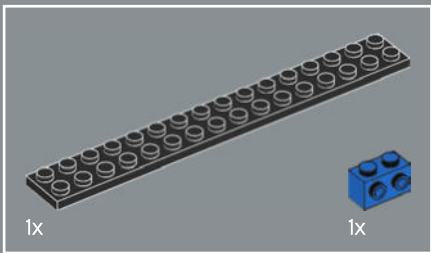
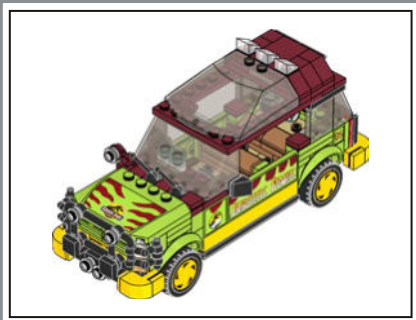
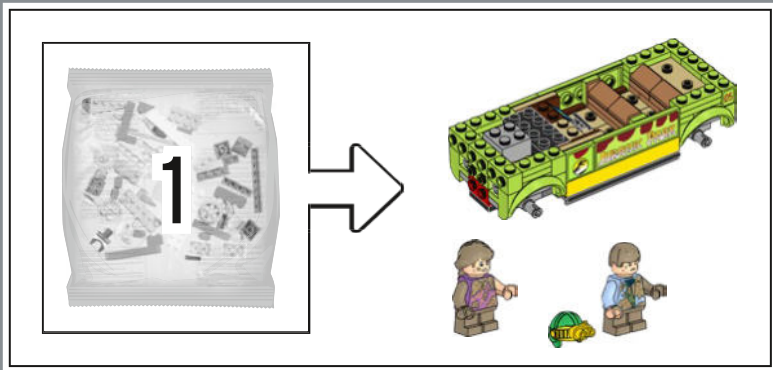

1

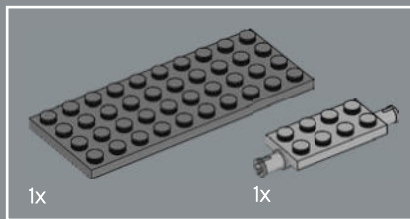
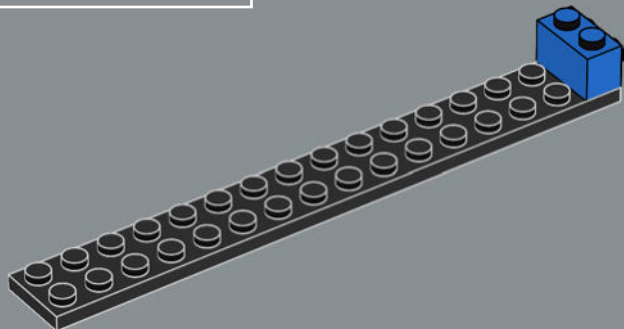

2

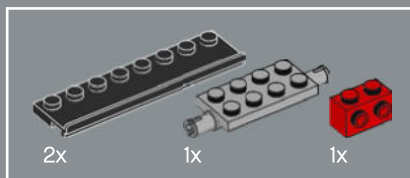
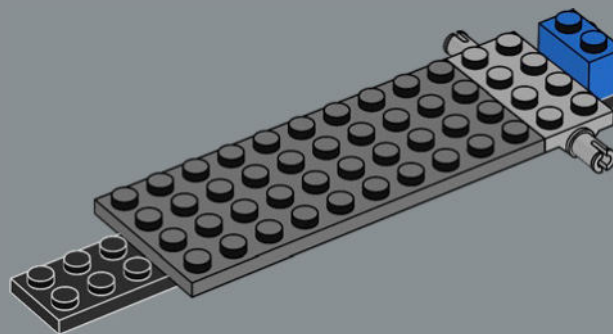

3

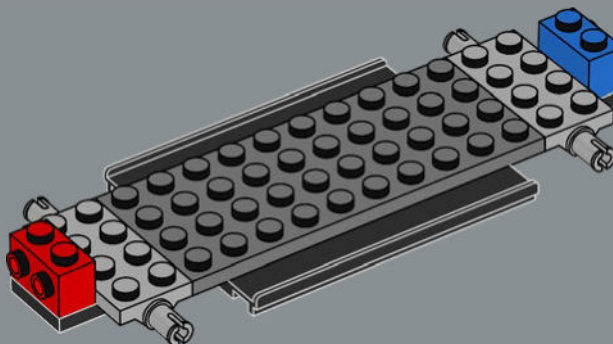



4

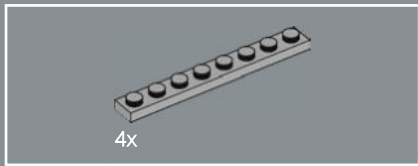
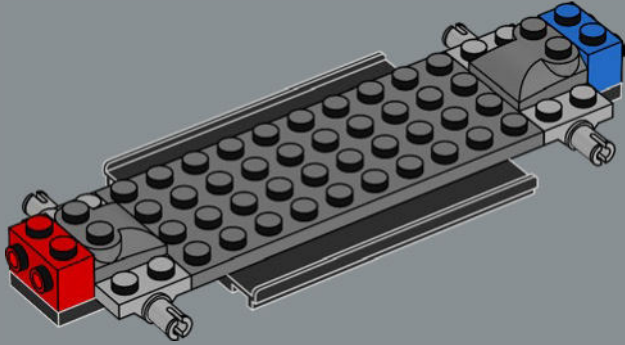

5

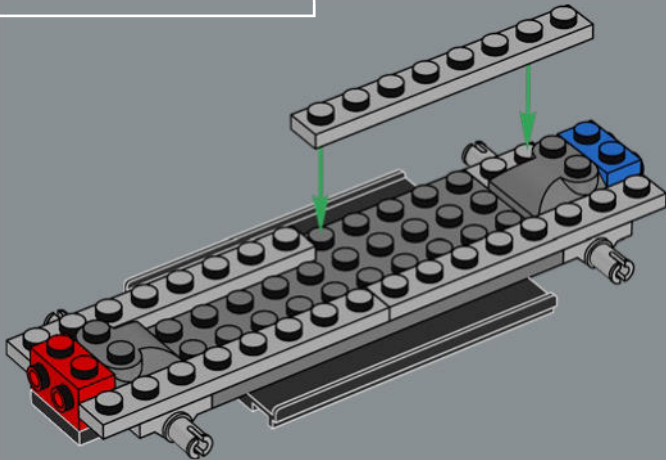

6

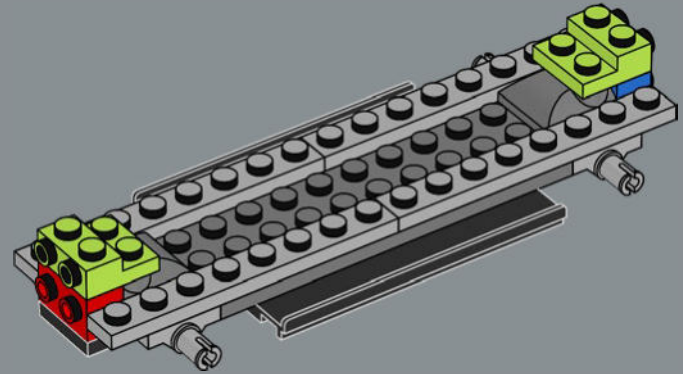

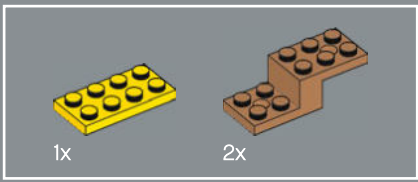

7

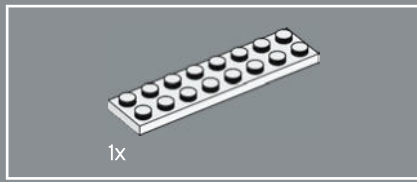
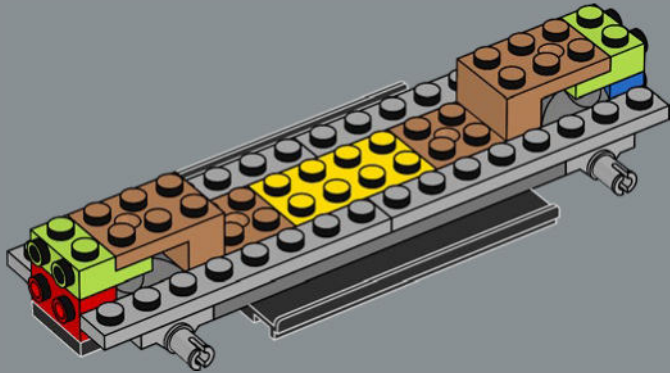

8

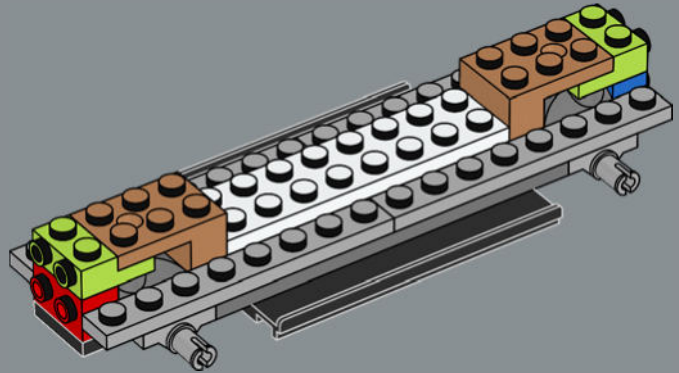



9

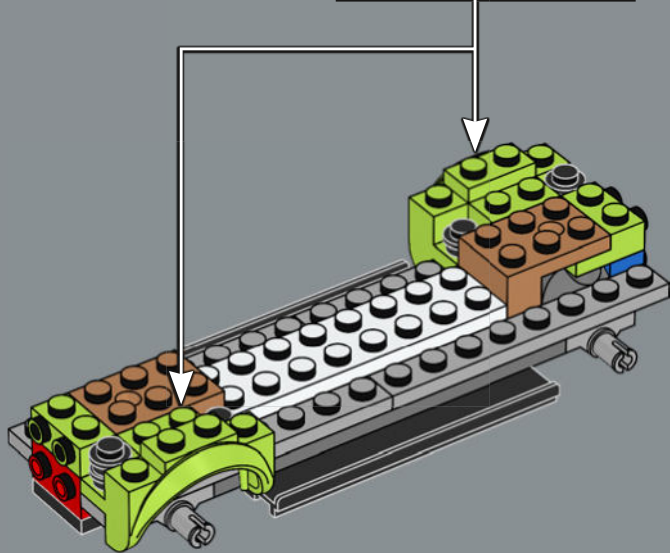
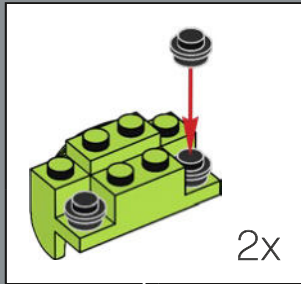

10

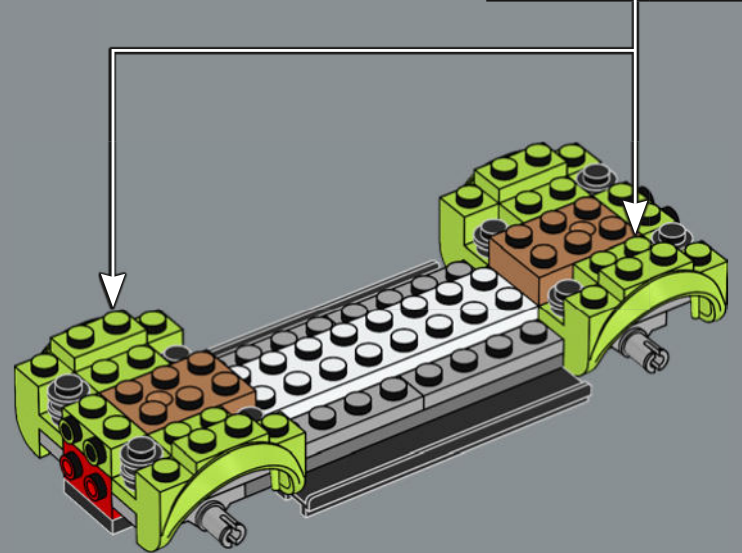
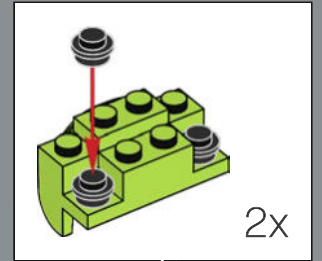



8x

11

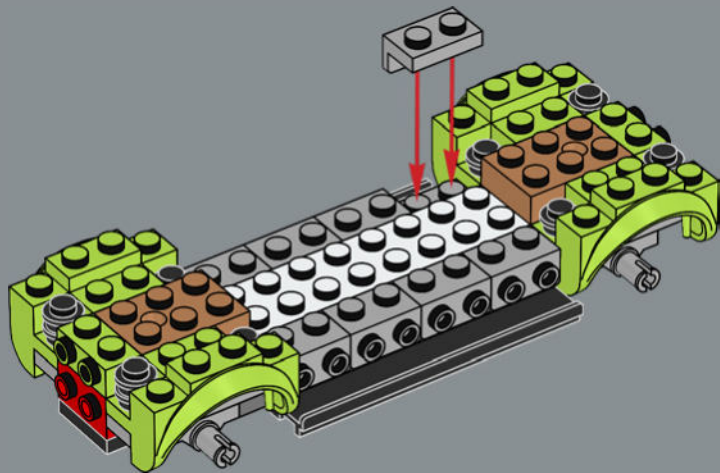

2x



1x



4x

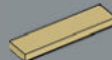

2x

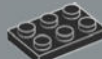

1x

12

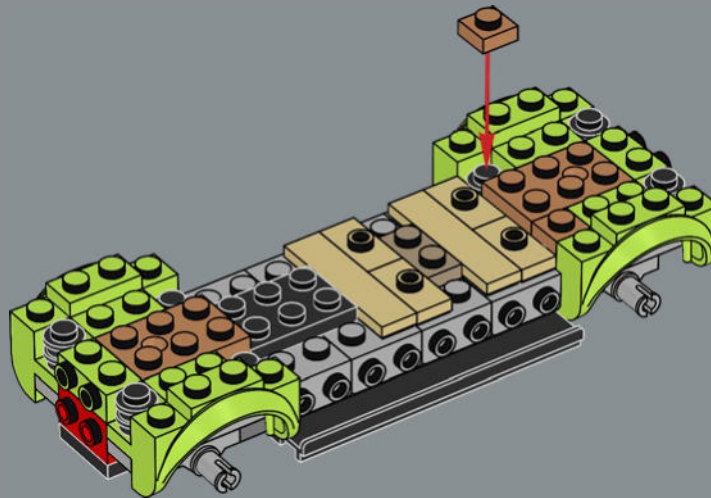

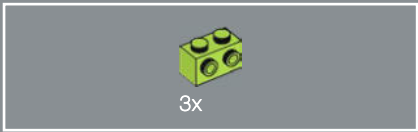

13

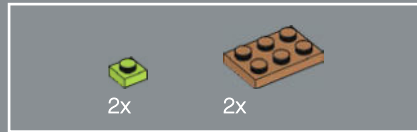
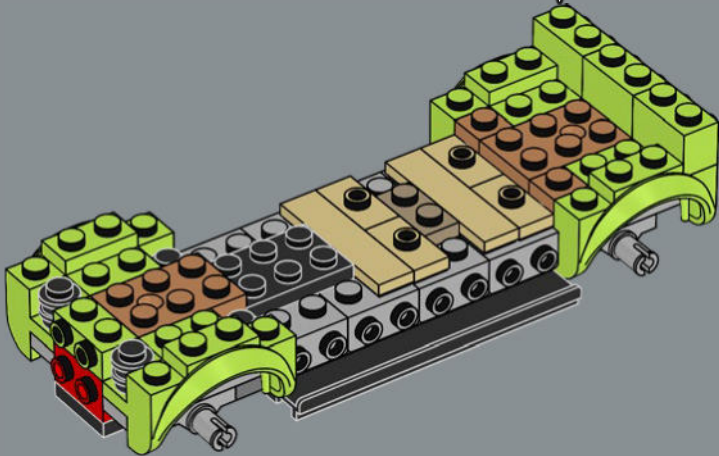
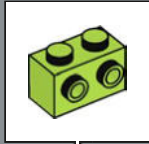

14

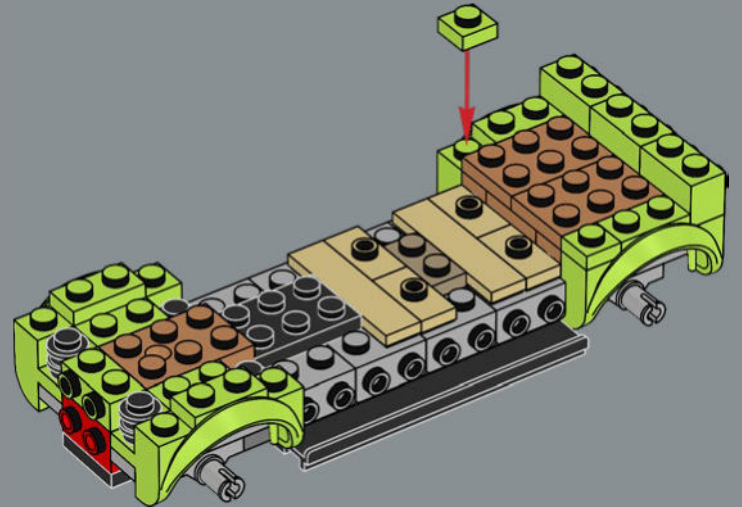

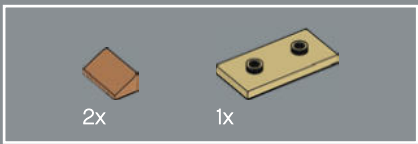

15

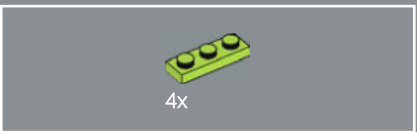
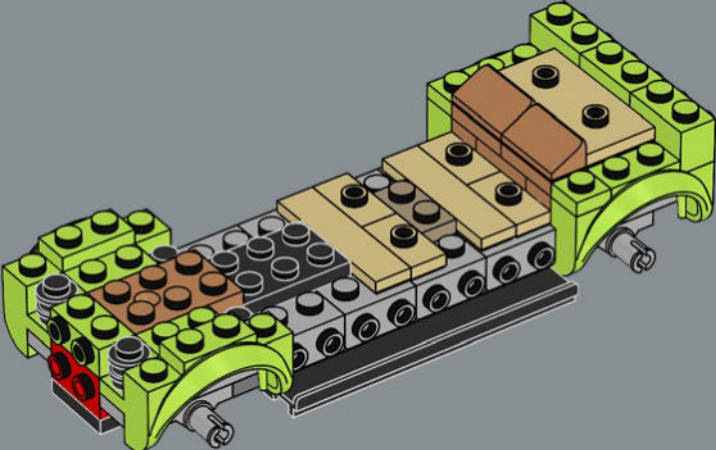

16

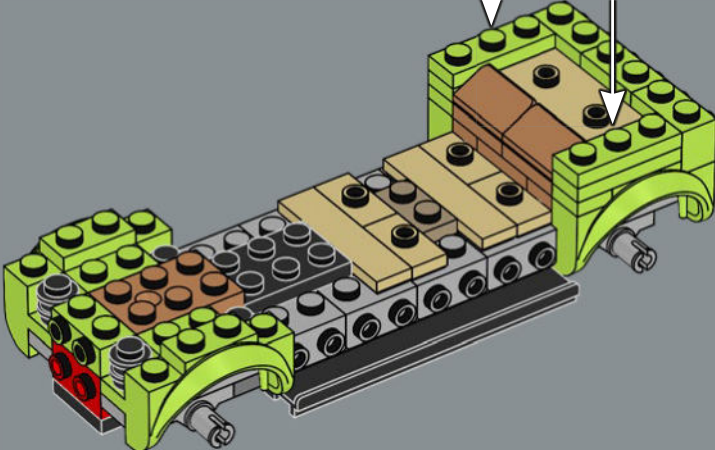
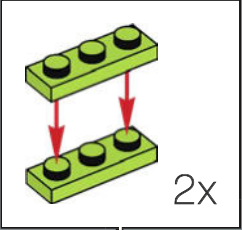



17

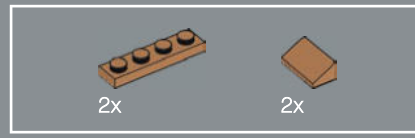
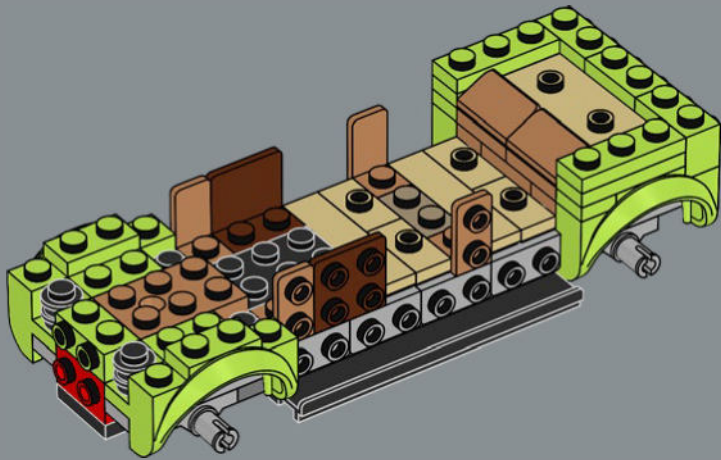

18

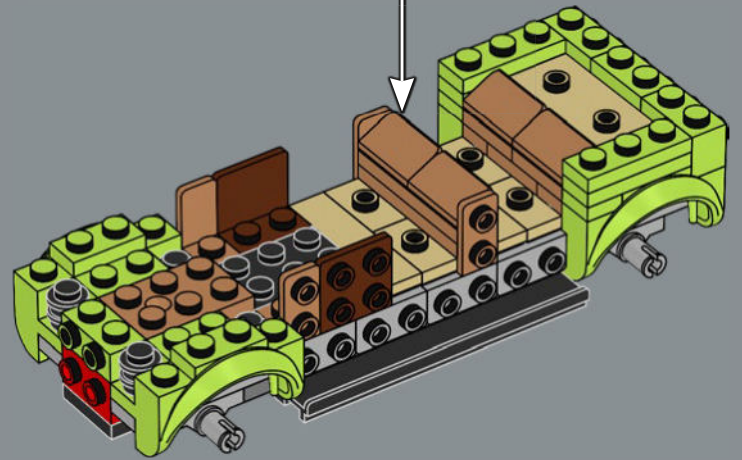
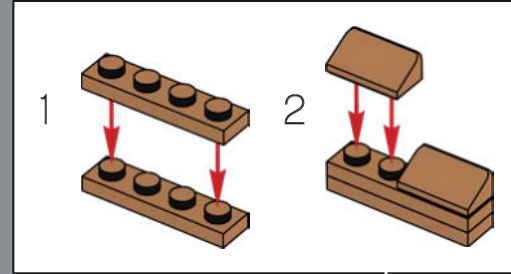



19

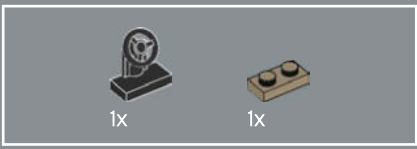
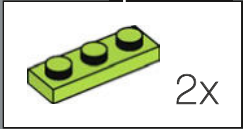
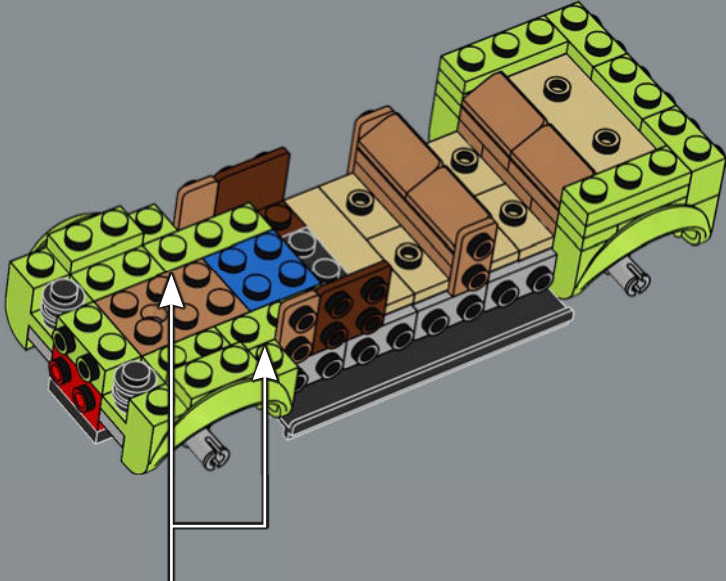

20

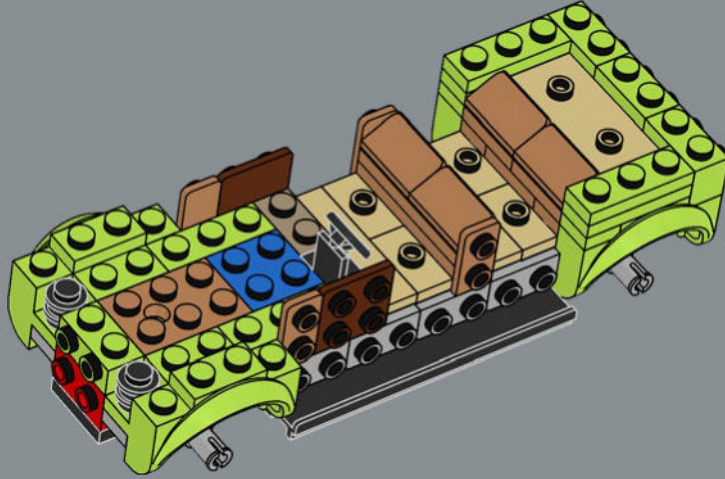

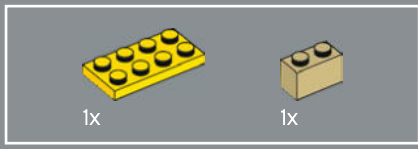

21

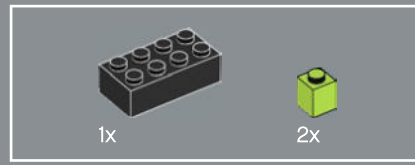
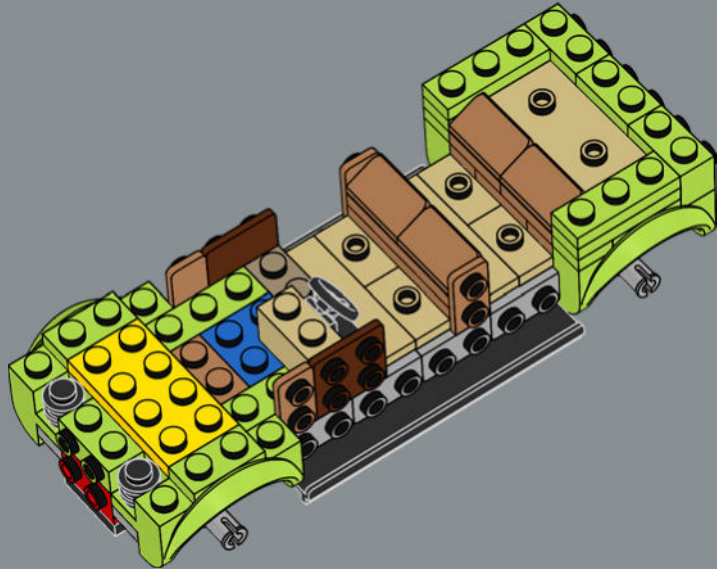

22

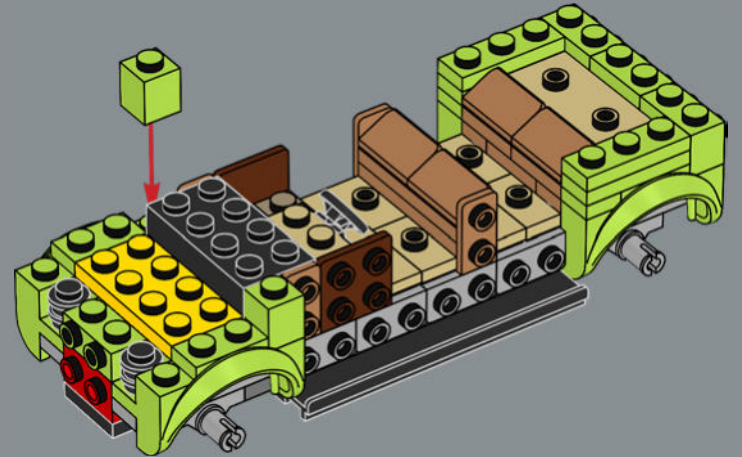



23

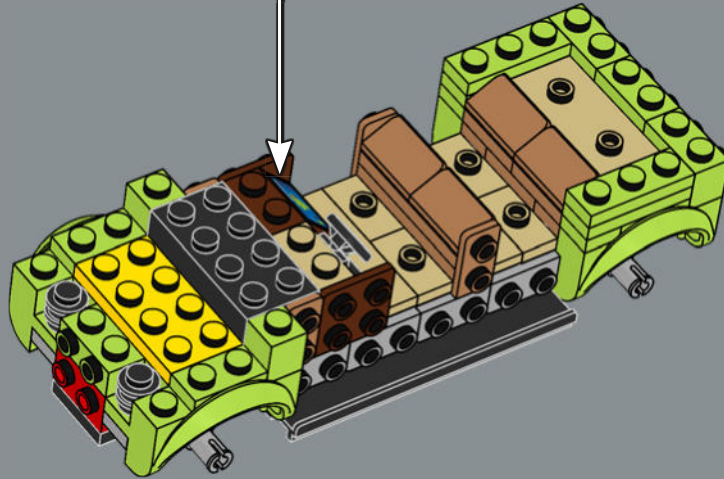
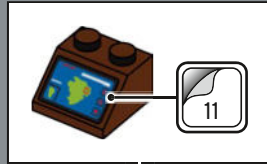

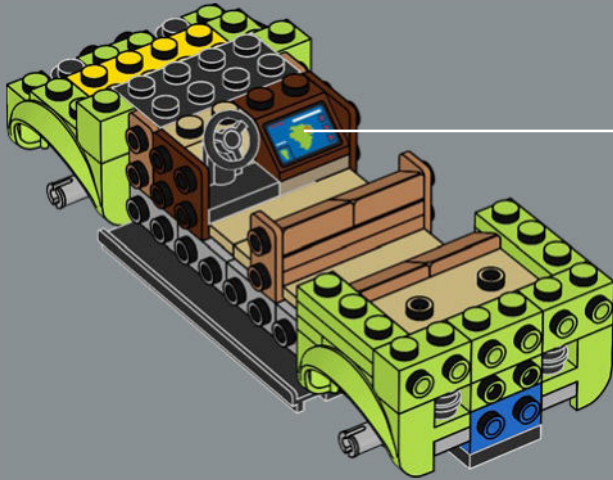

TYRANNOSAURUS TECH

These days we're used to slick, uber-thin phones, tablets and laptops giving us real-time information and entertainment. But back in 1993, this interactive touch-screen CD-ROM drive was the bleeding-edge of tech. You might struggle to fit it in your pocket though...



4x

24

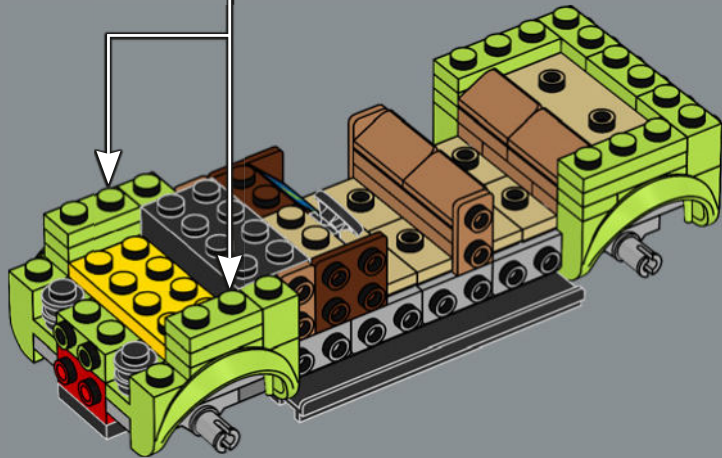
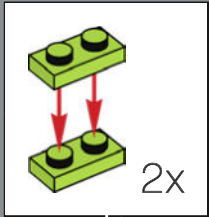

1x

25

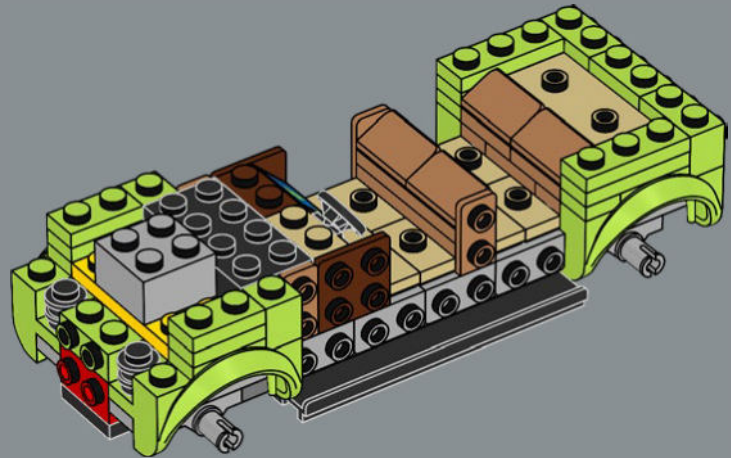



26

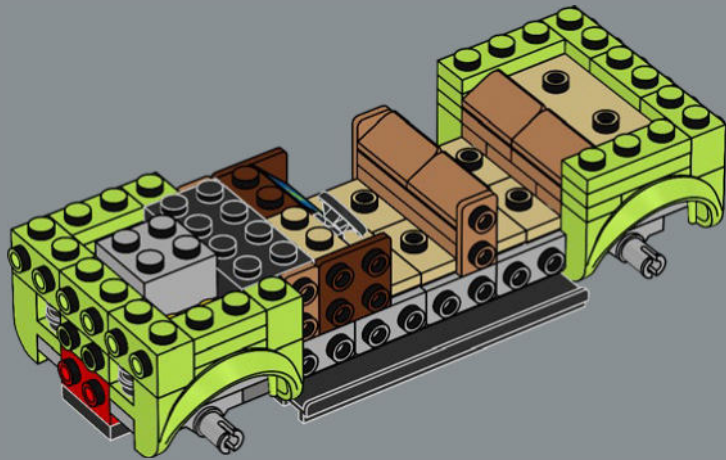

27

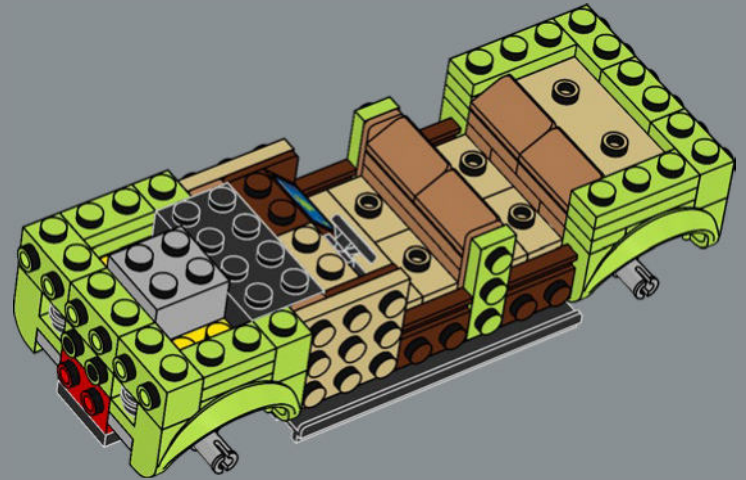

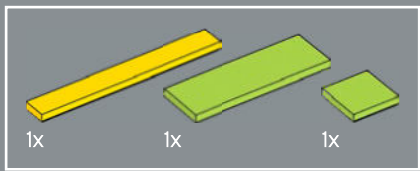

28

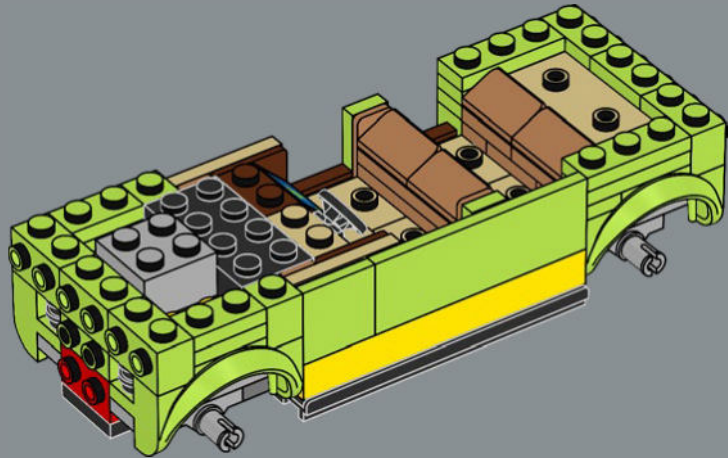

29

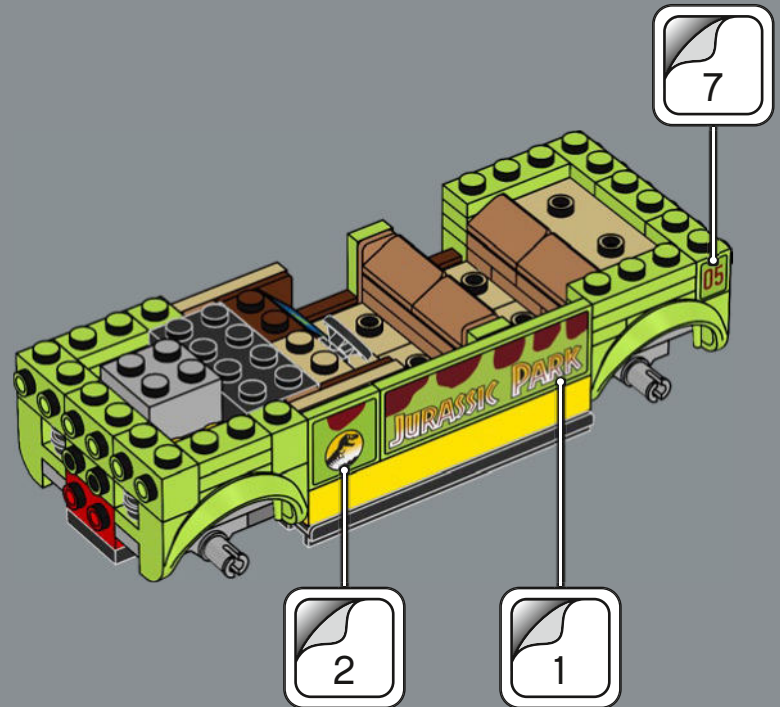

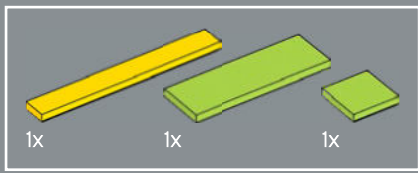

30

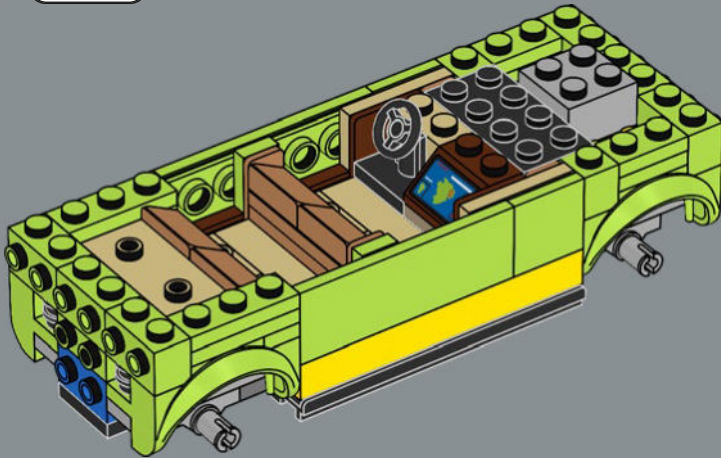

31

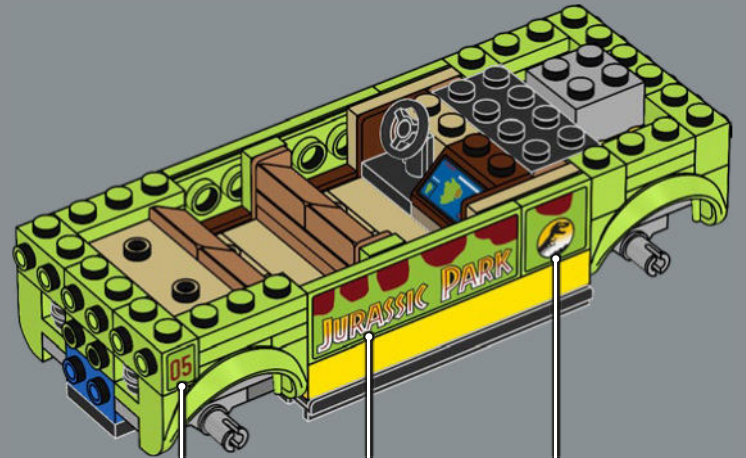

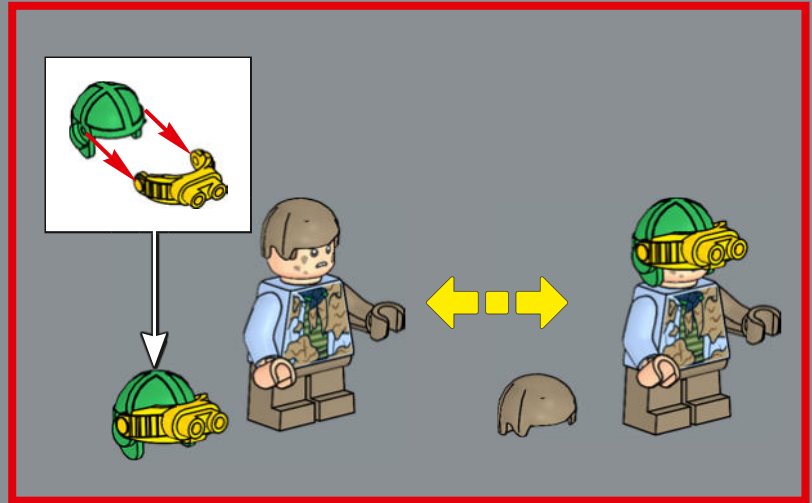
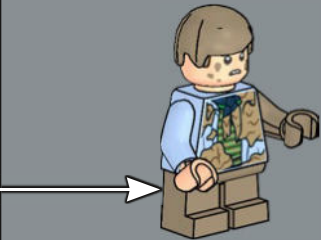
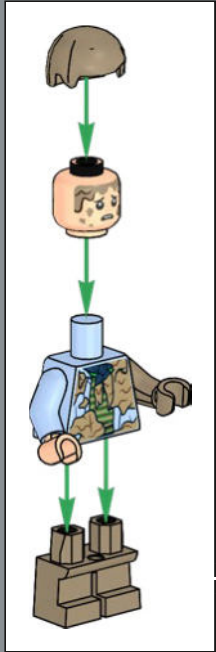



NIGHT VISION

Pros of night vision goggles = you can see in the dark. Cons of night vision goggles = You might not like what you see coming...

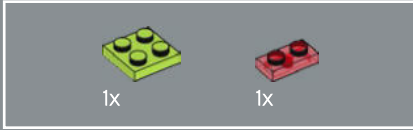
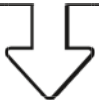

32

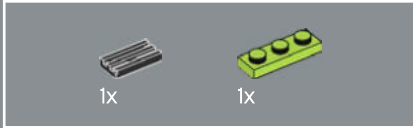
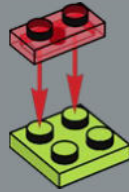

33

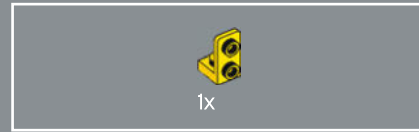
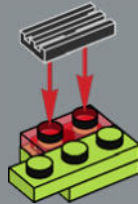

34

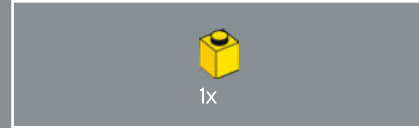

35



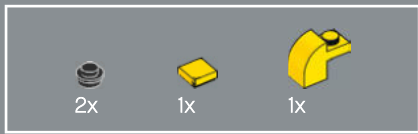

36

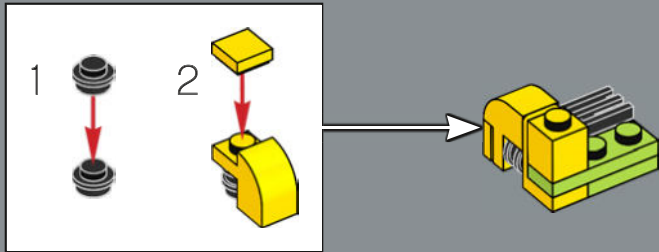

37

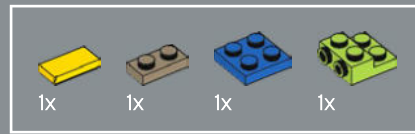
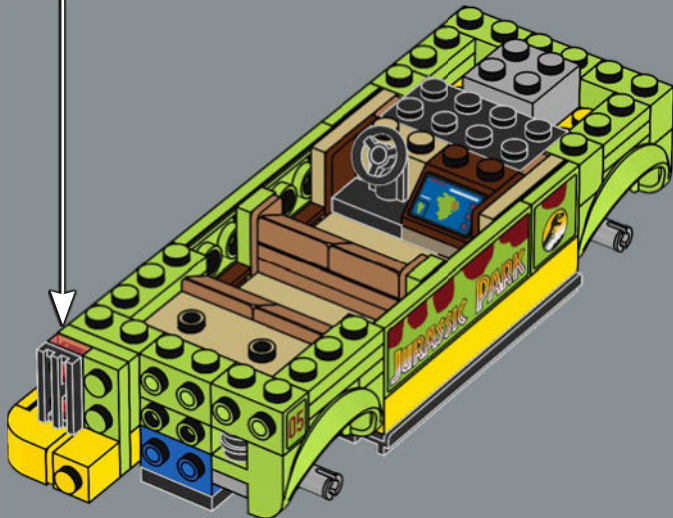

38

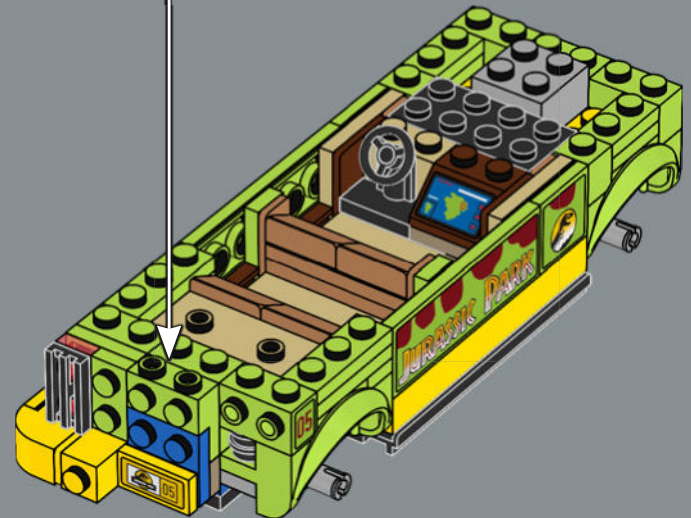
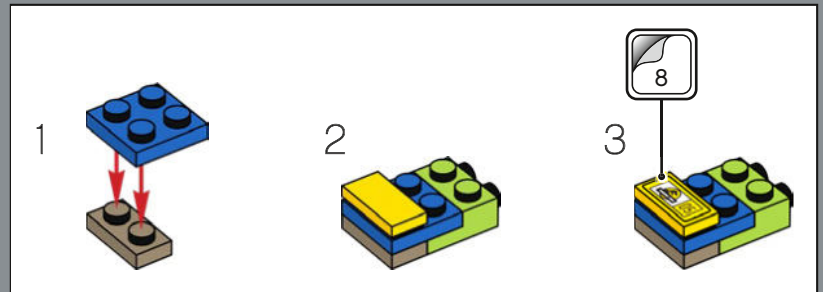

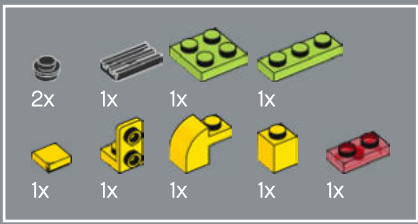

39

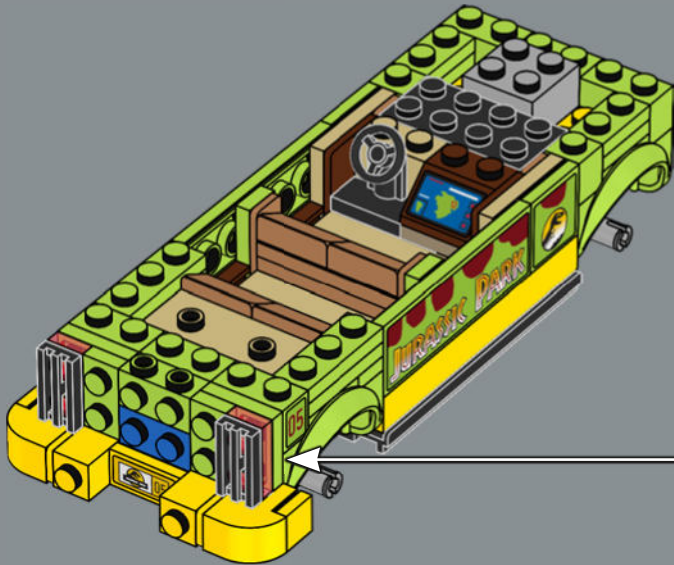
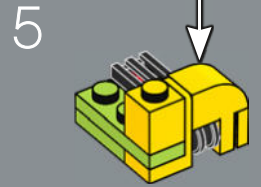
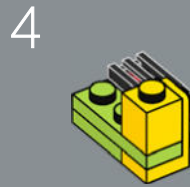
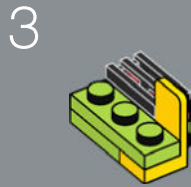
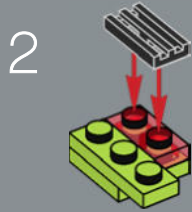
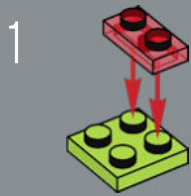
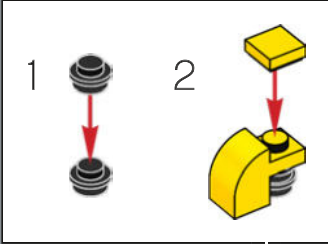

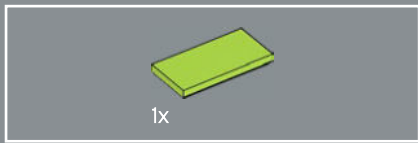

40

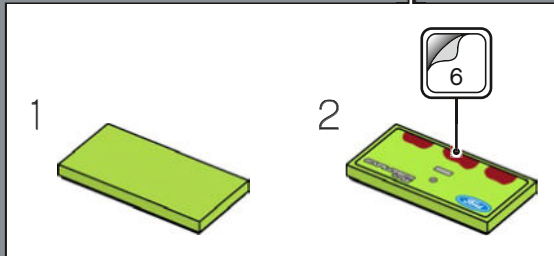
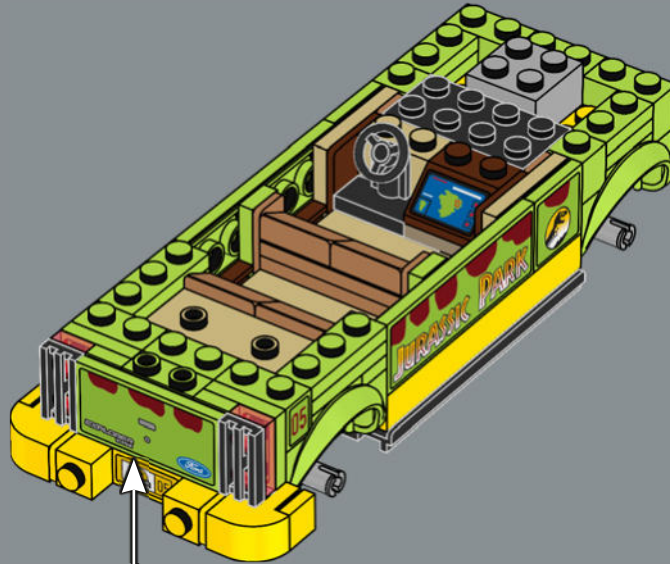



41

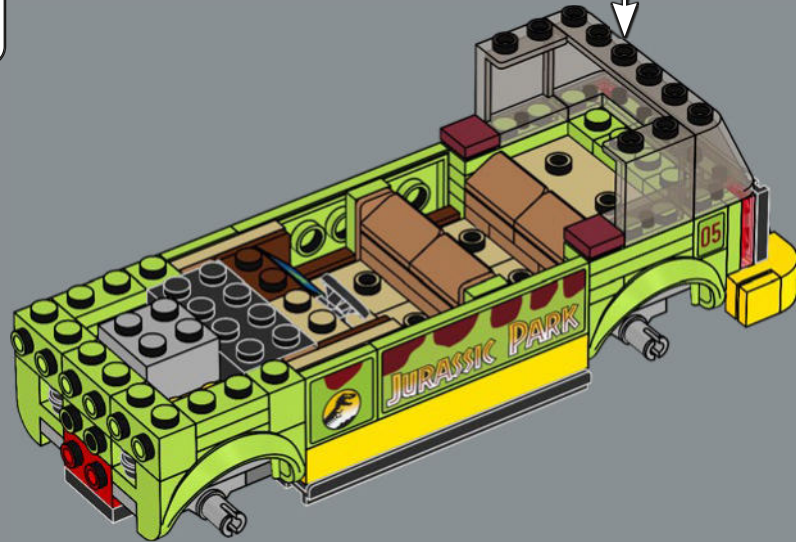
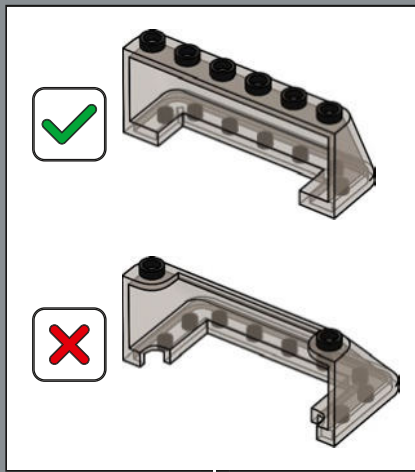

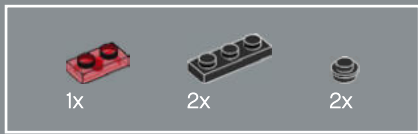

42

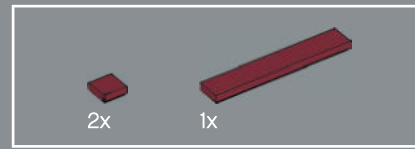
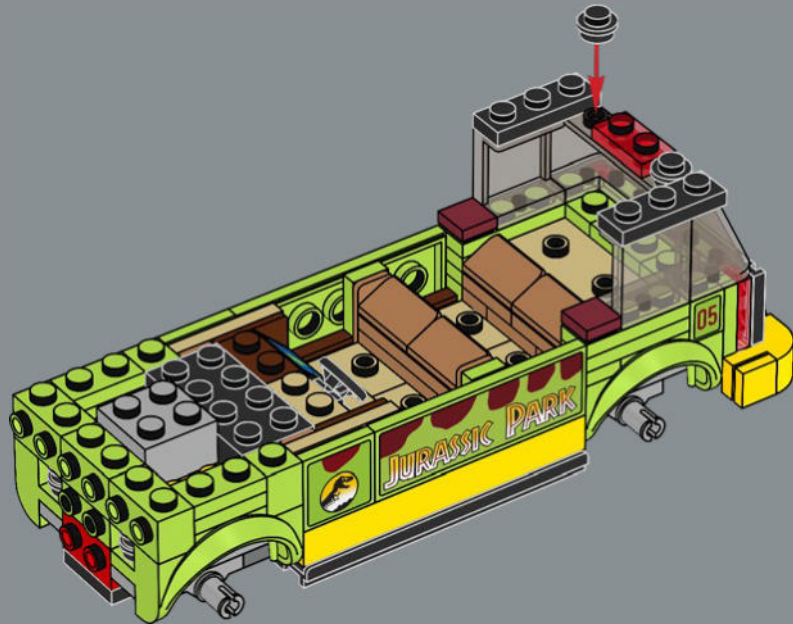

43

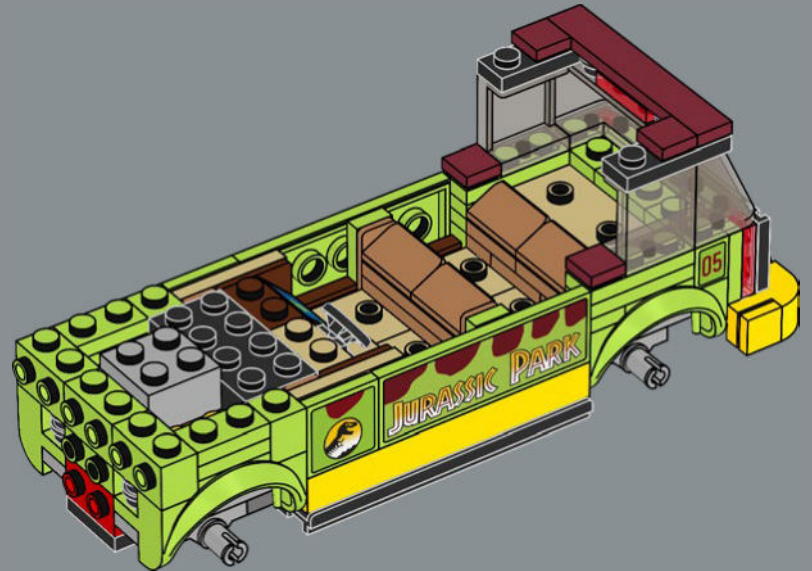



44

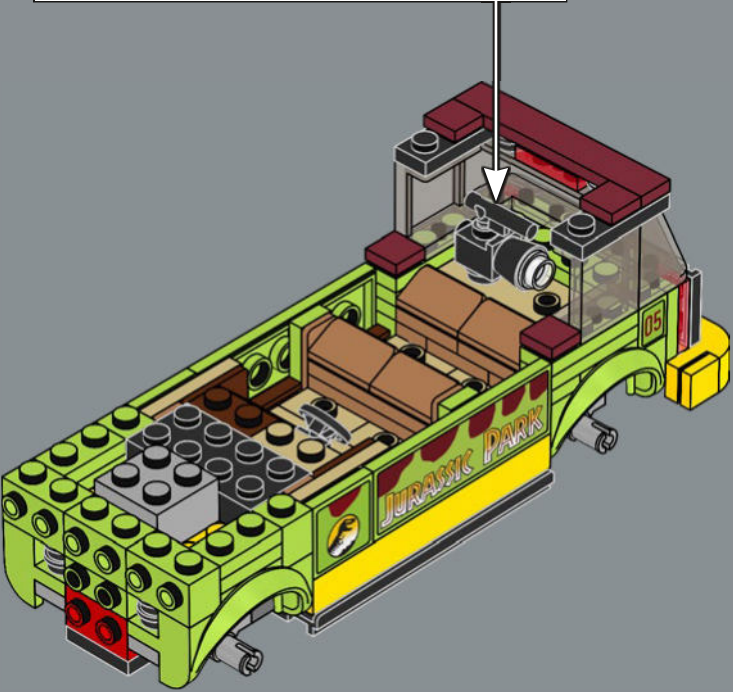
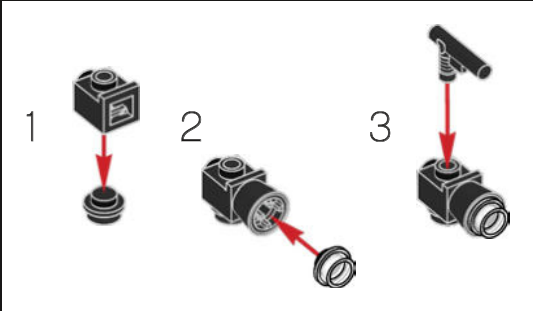

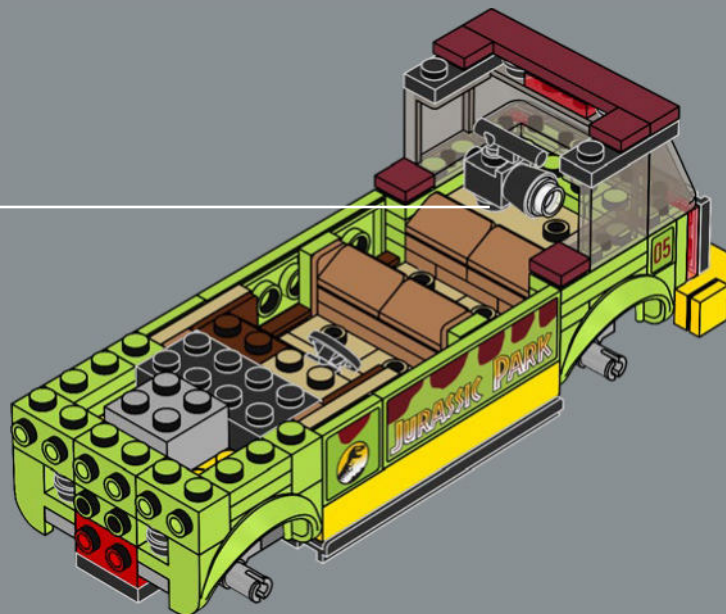

"TURN THE LIGHT OFF, TURN THE LIGHT OFF!"

In an ideal world, Lex would have stayed still and calm and waited for that angry T. rex to walk right by. But where's the fun in that when you can frantically wave a powerful torch instead?

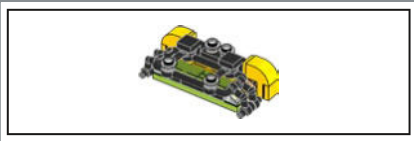

45

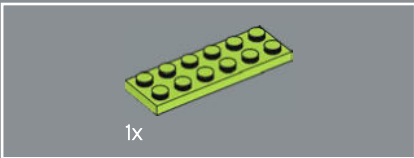
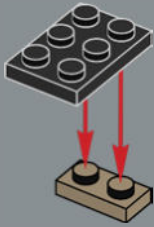

46

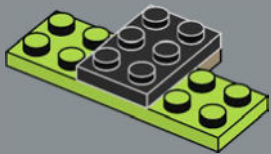

47

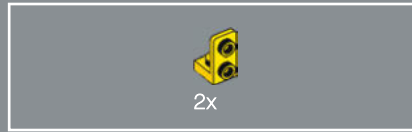
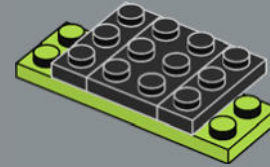

48

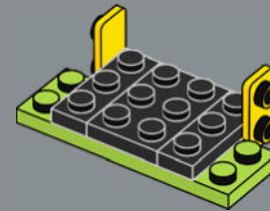



49

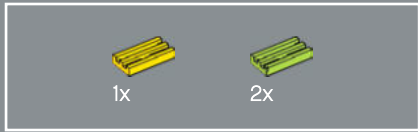
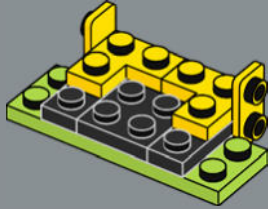

50

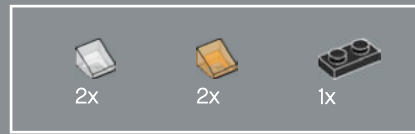
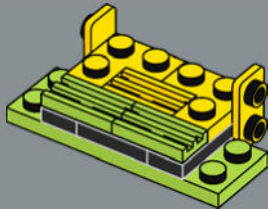

51

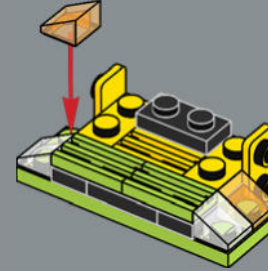

52

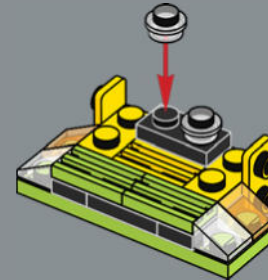



53

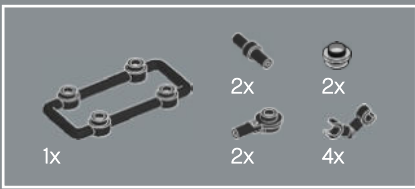
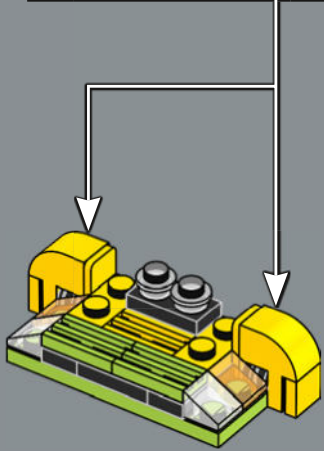
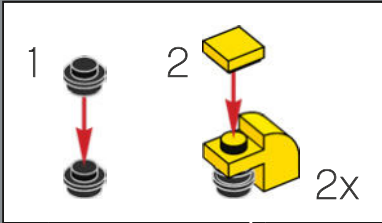

54

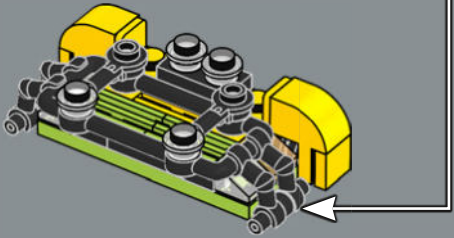
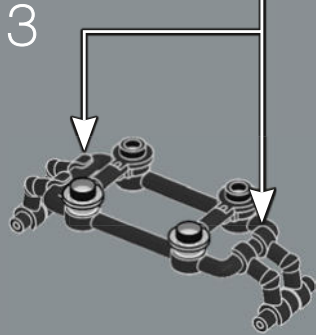
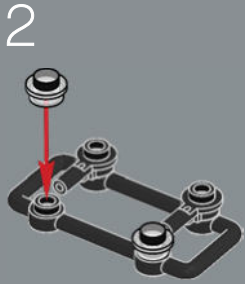
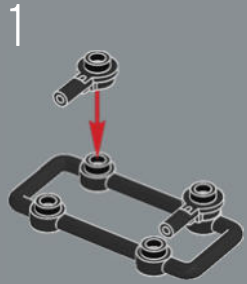
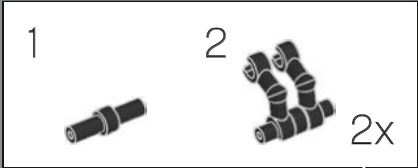



55

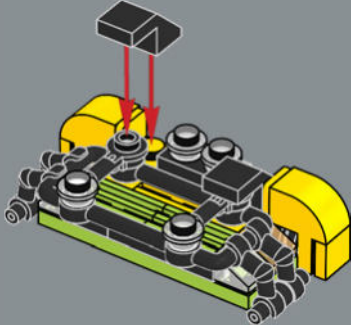

56

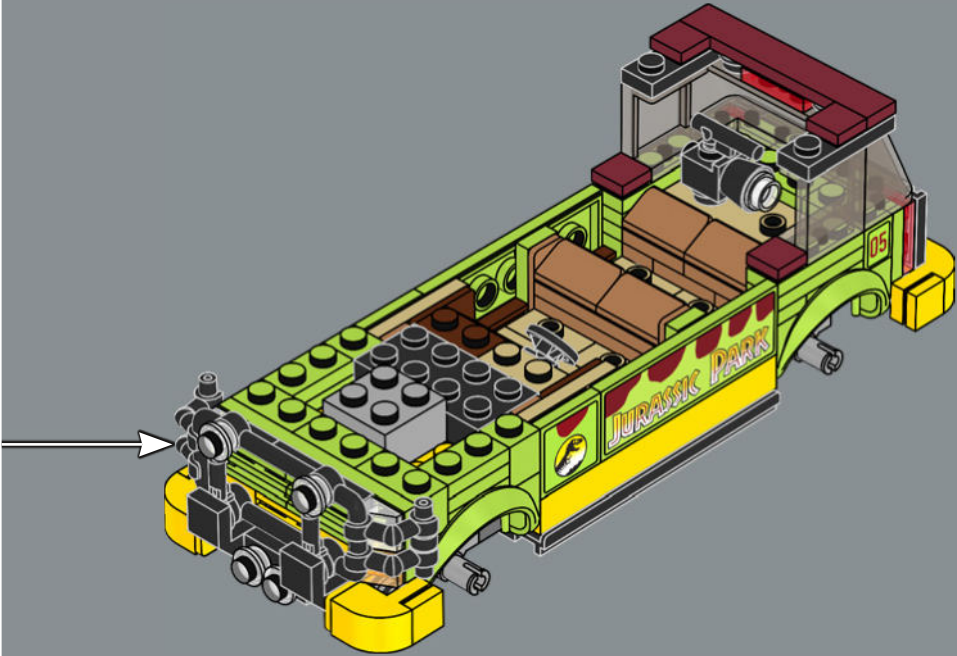

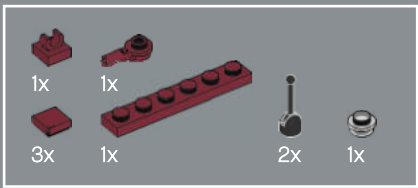

57

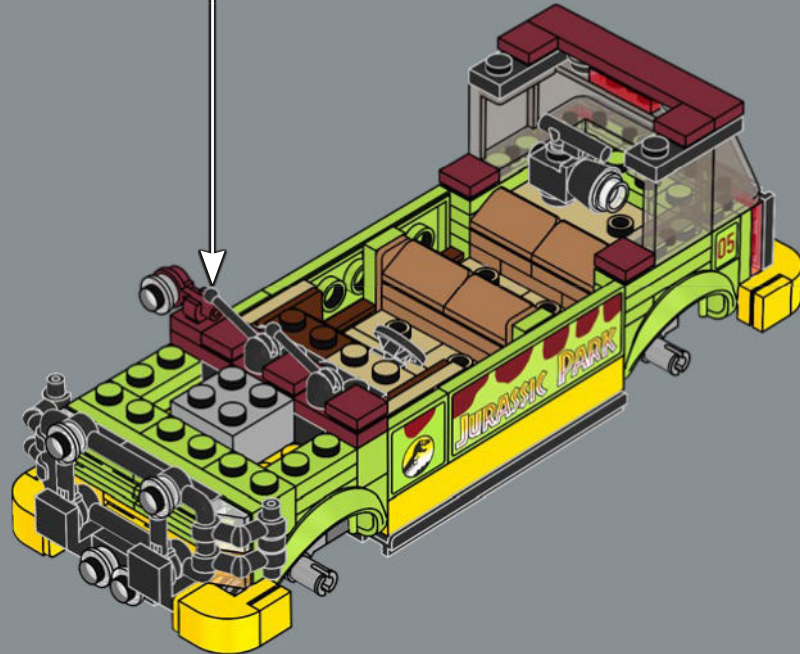
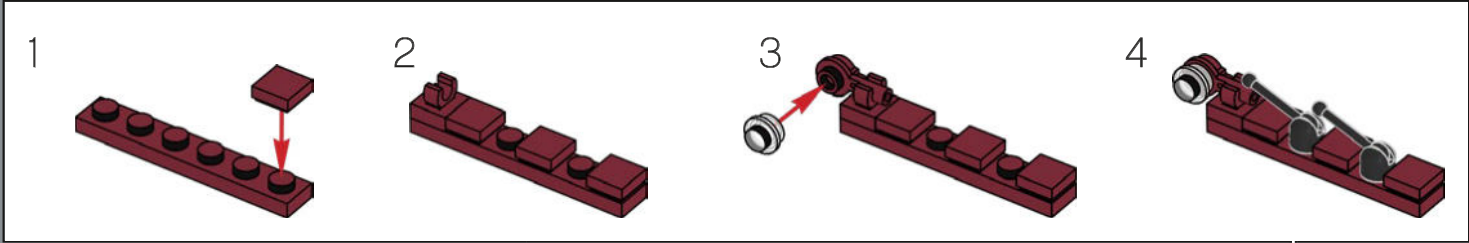

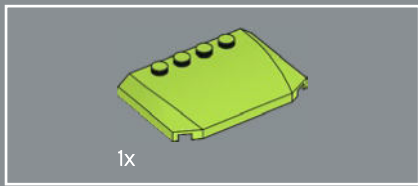

58

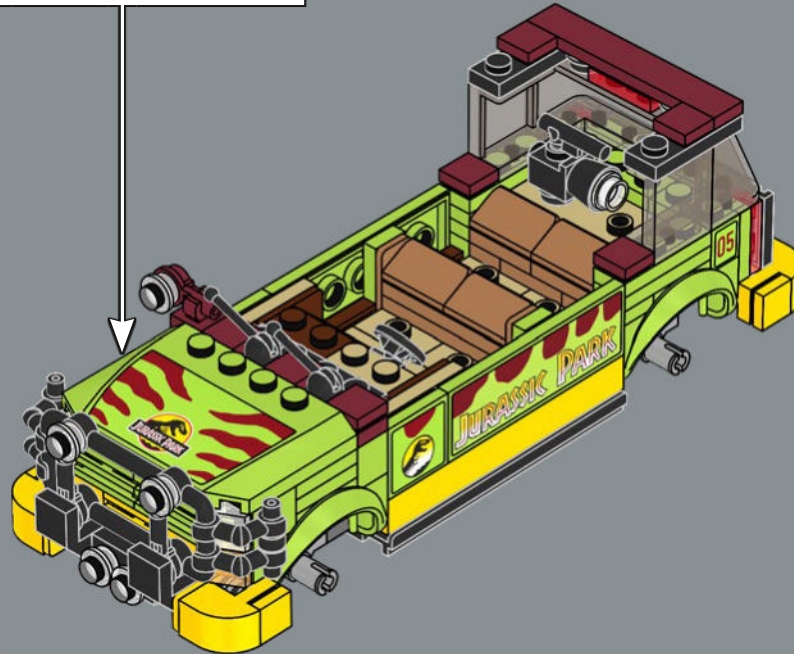
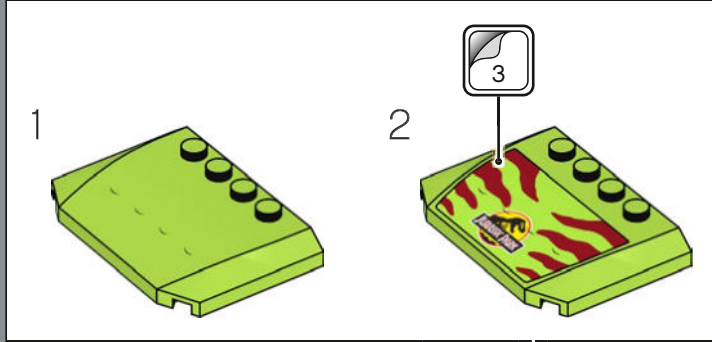

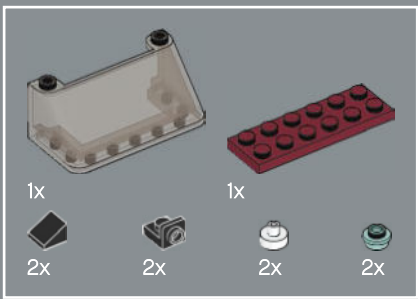

59

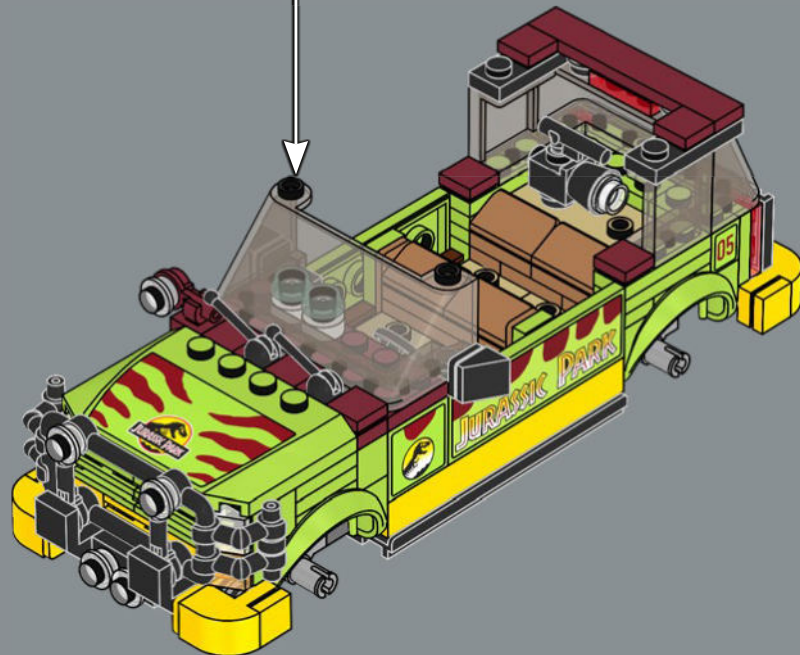
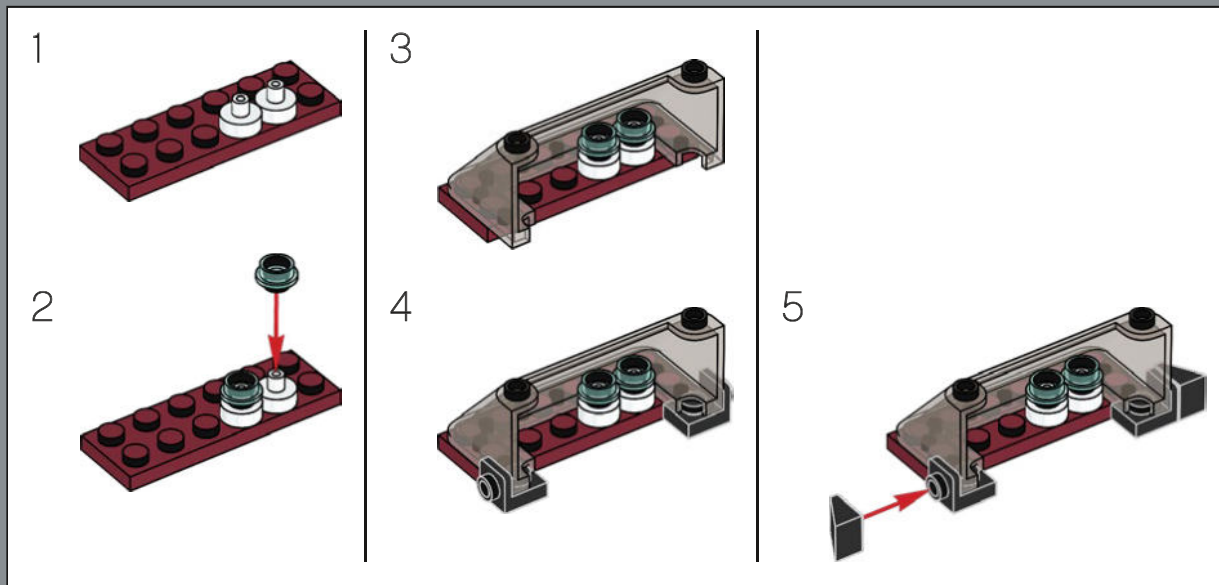

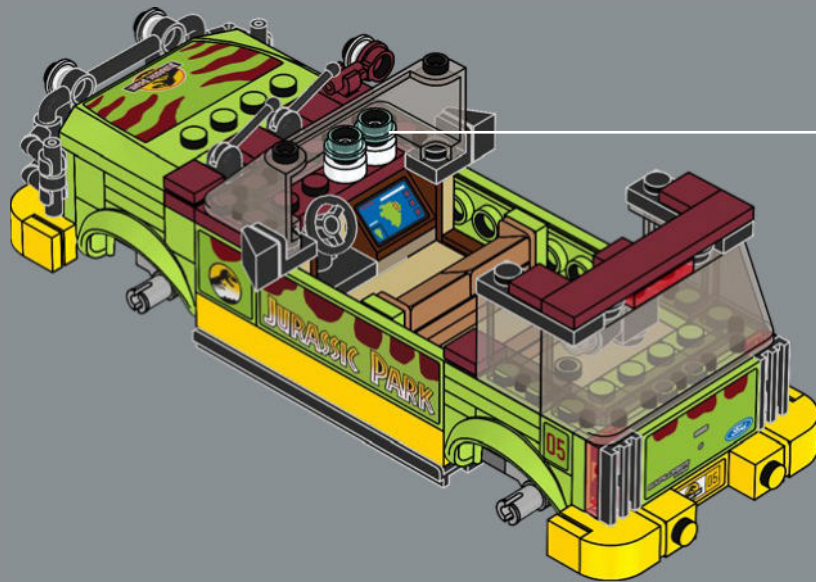

"DID YOU FEEL THAT?"

How do you tell people the T. rex is coming, *without telling people the T. rex is coming*? All you need are two cups of water, something gargantuan enough to shake them, and voila ... cinematic history!

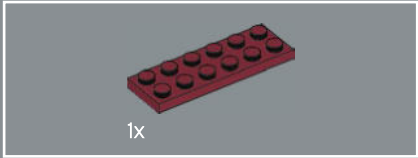
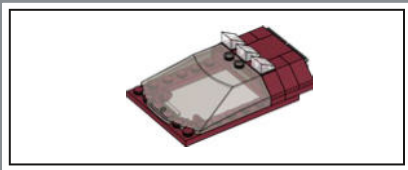

1x

60

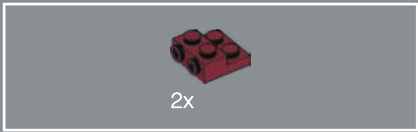
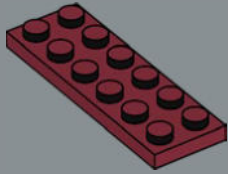

2x

61

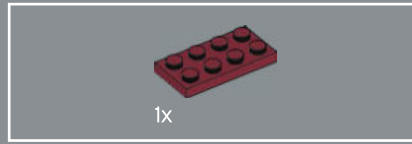
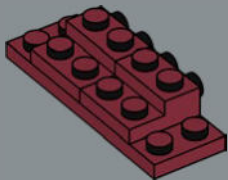

1x

62

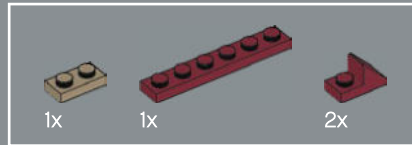
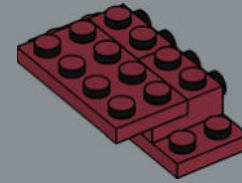

1x

1x

2x

63

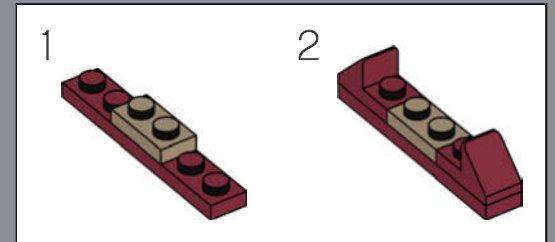

1

2

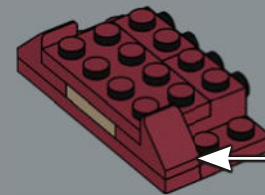



64

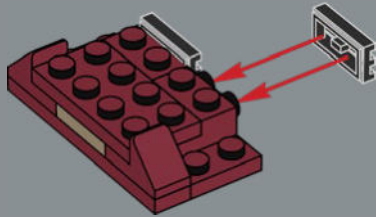

65

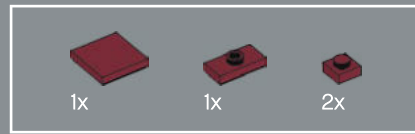
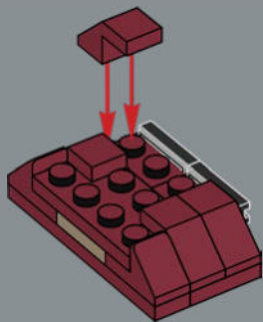

66

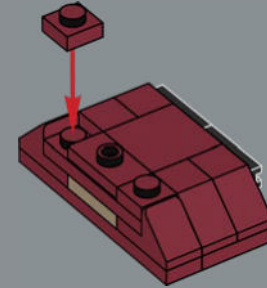

67

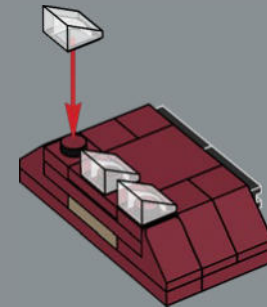

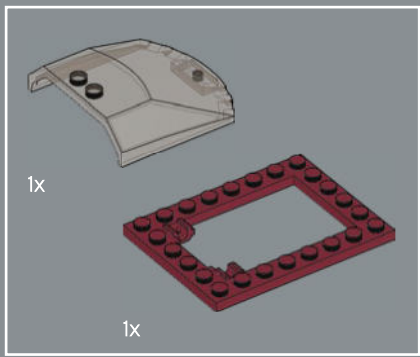

68

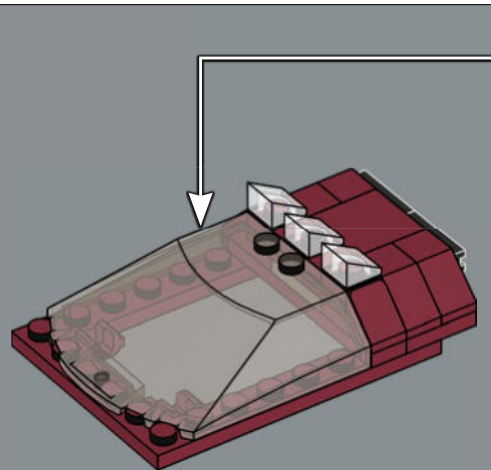
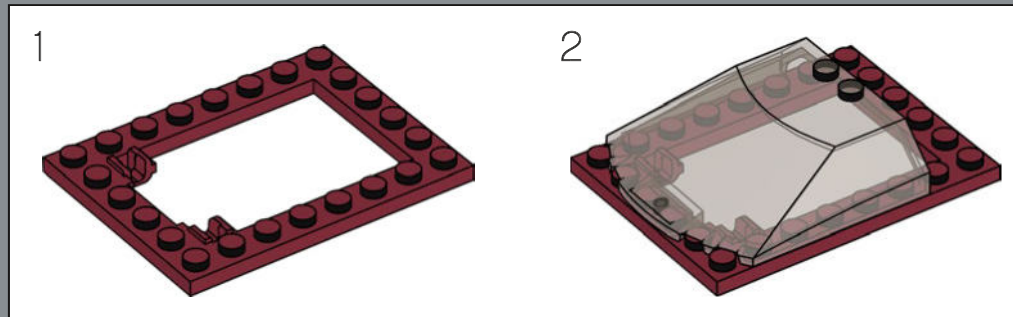

69

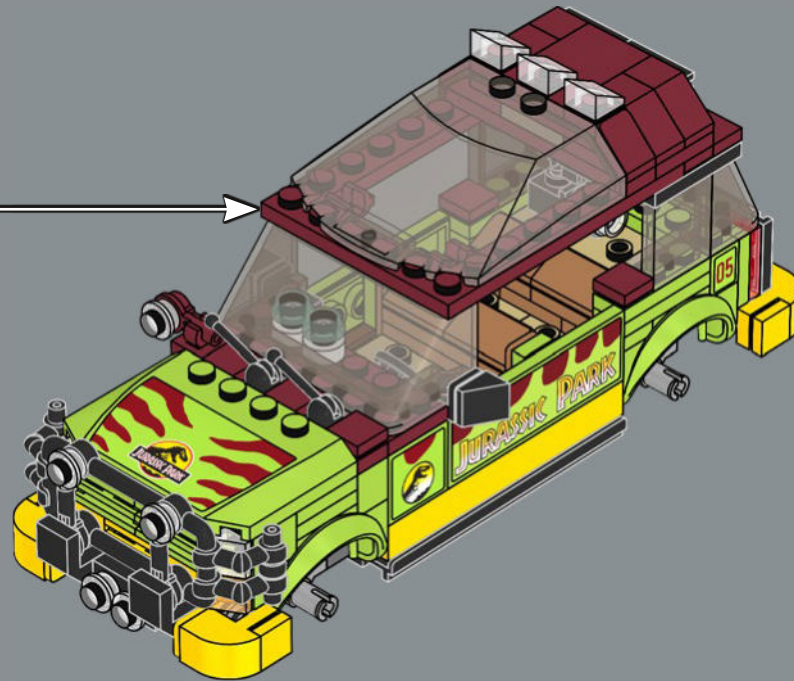



70

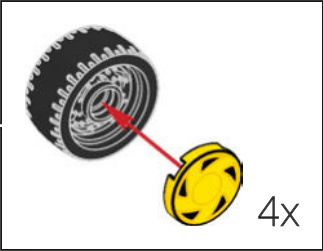
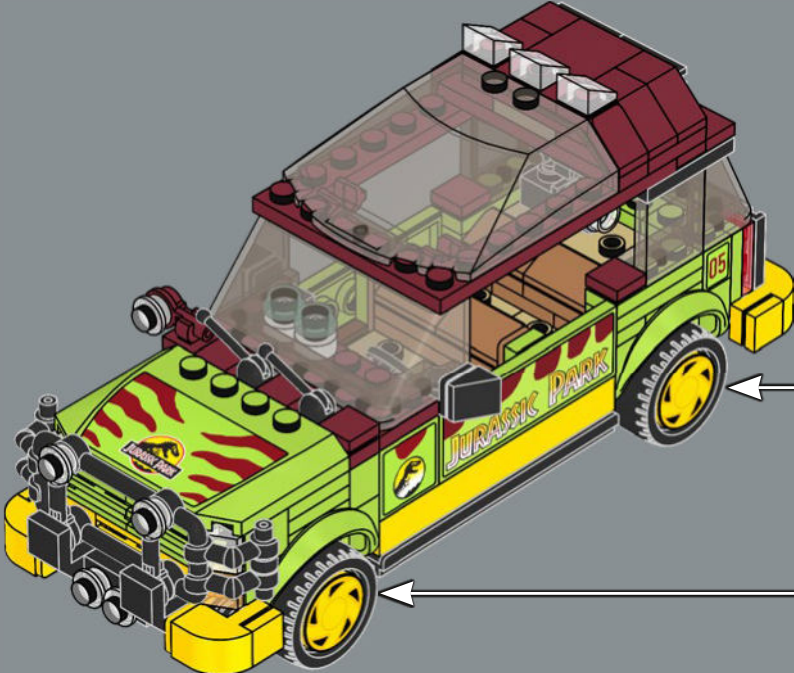

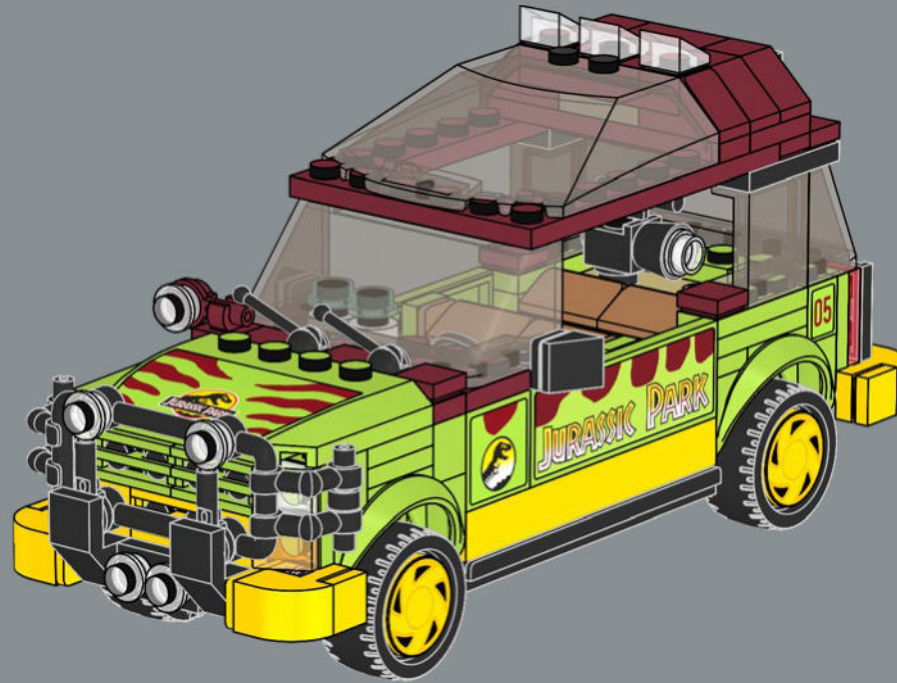

MADE FOR EXPLORING

That panoramic glass roof. That iconic colour scheme and decals. Those bright yellow rims and chunky grill. Back in 1993, everyone dreamed of owning their own *Jurassic Park* Ford Explorer XLT. Unfortunately, there's now one less of them...

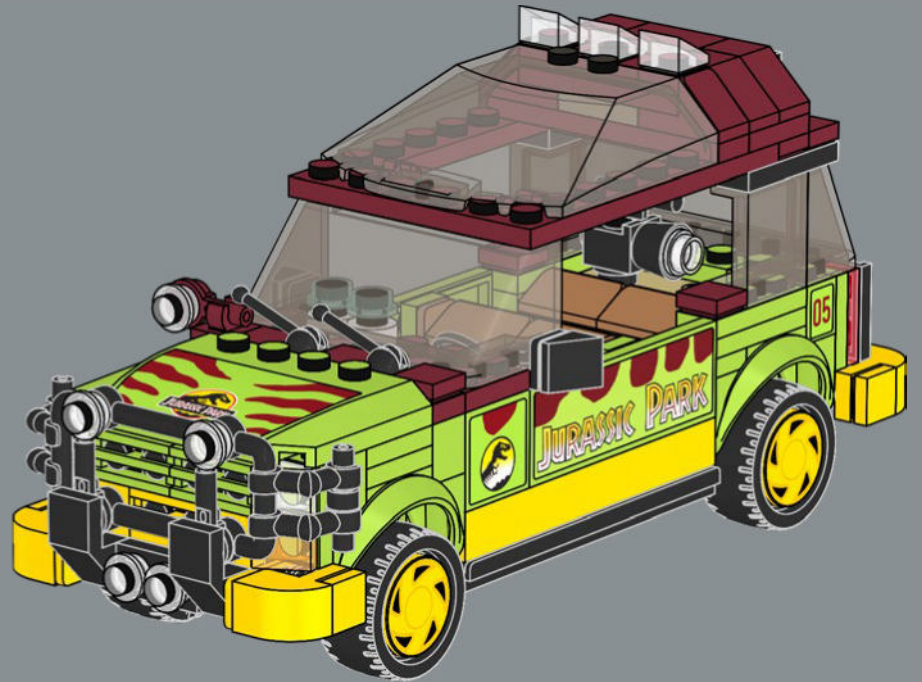
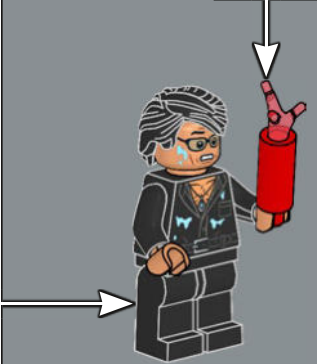
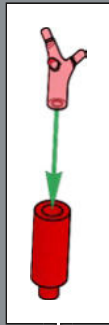
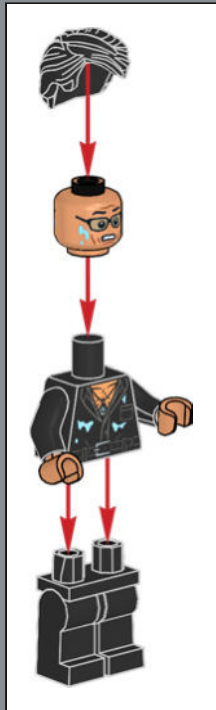

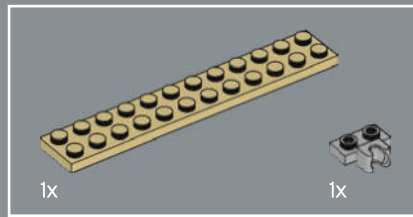
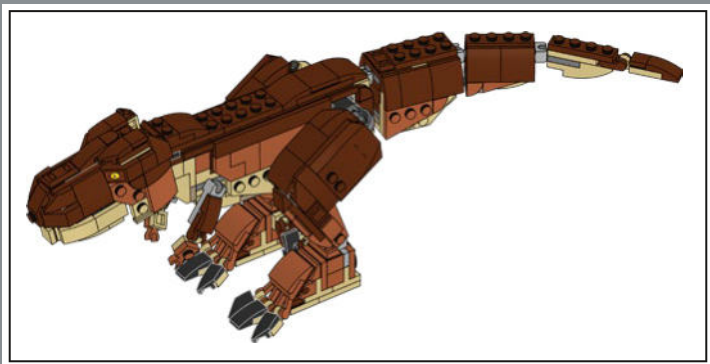
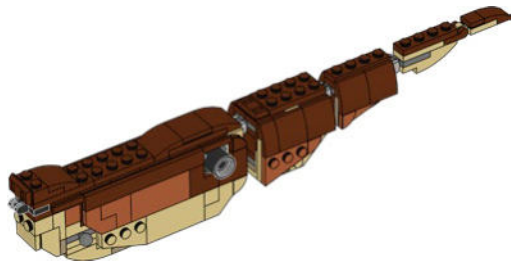

1

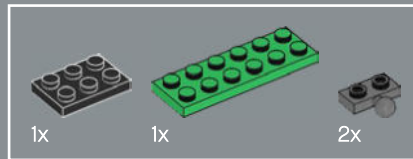
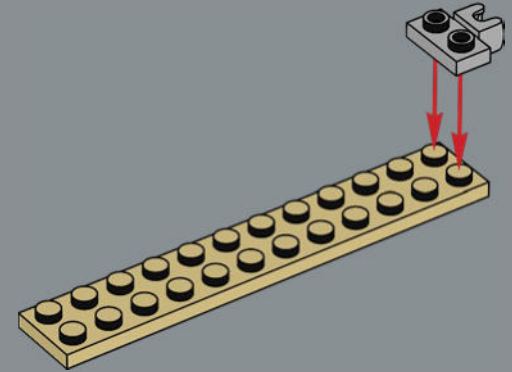

2

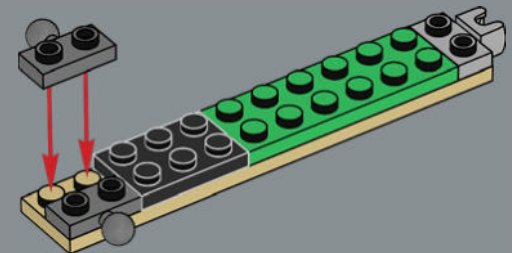

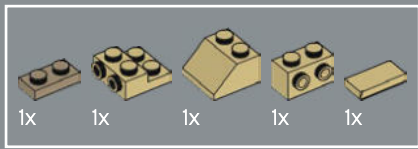

7

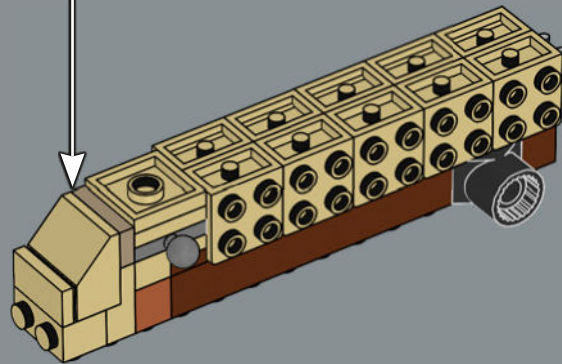
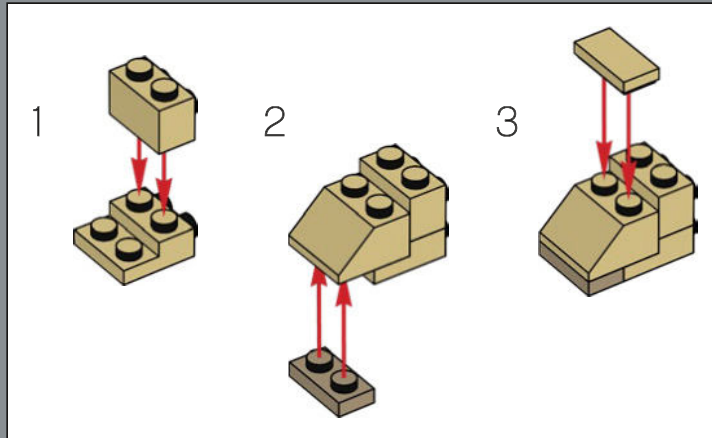

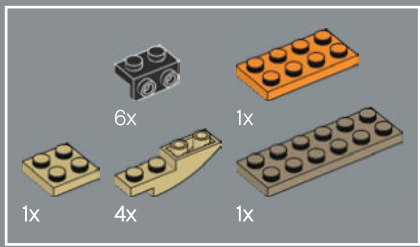

8

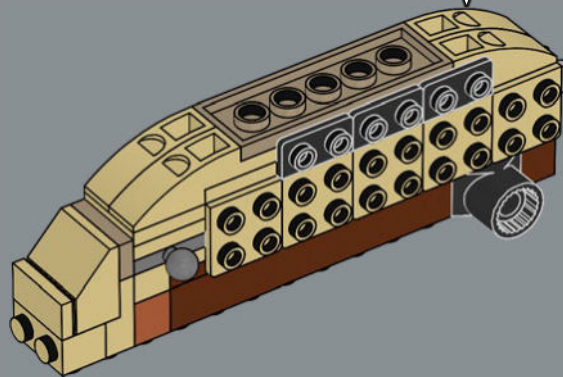
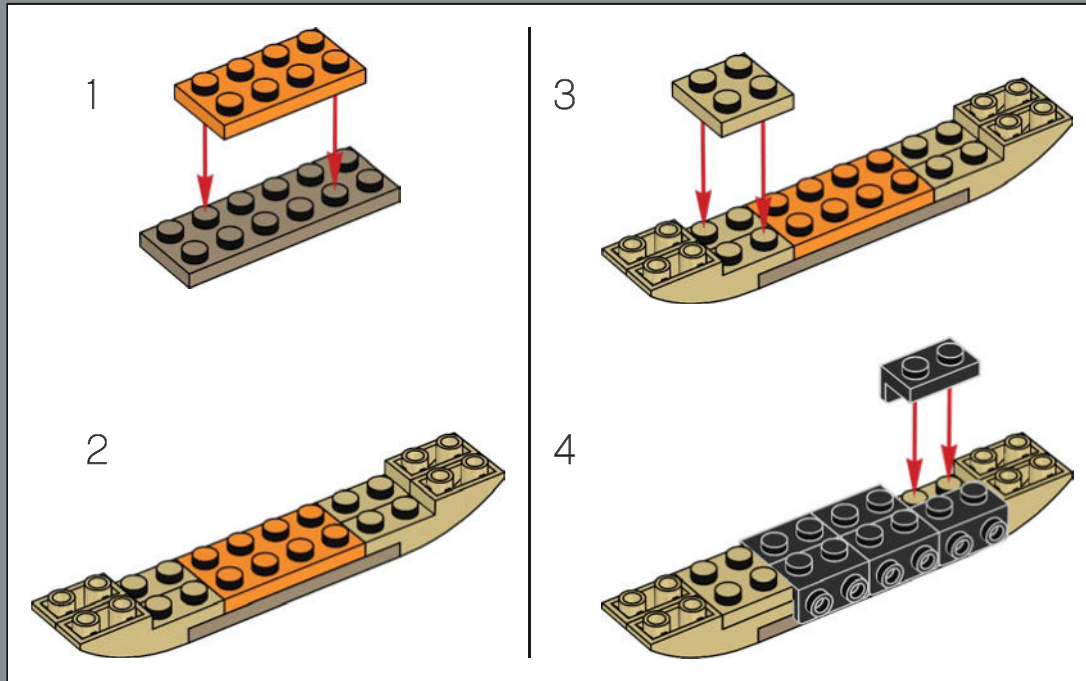

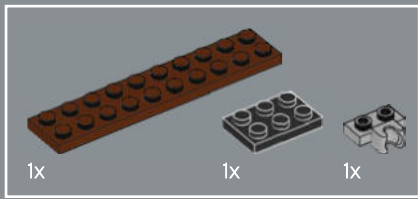

9

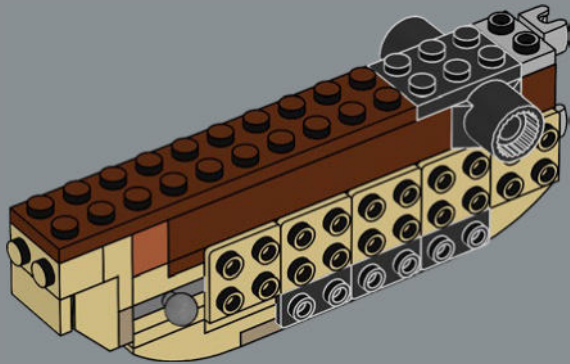

10

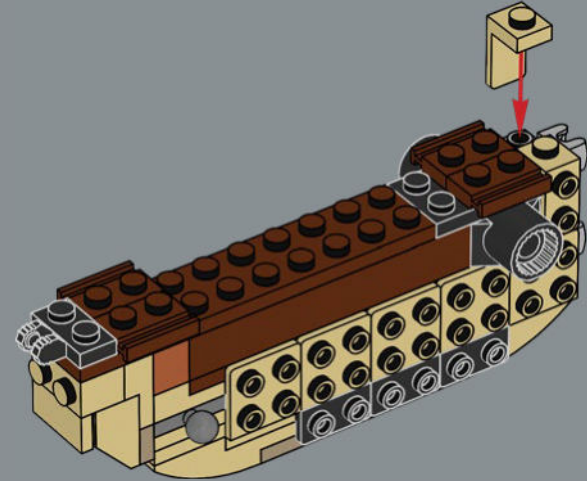



8x

11

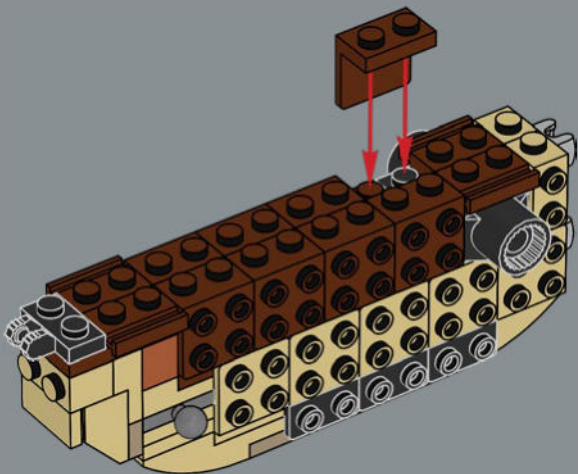

2x

12

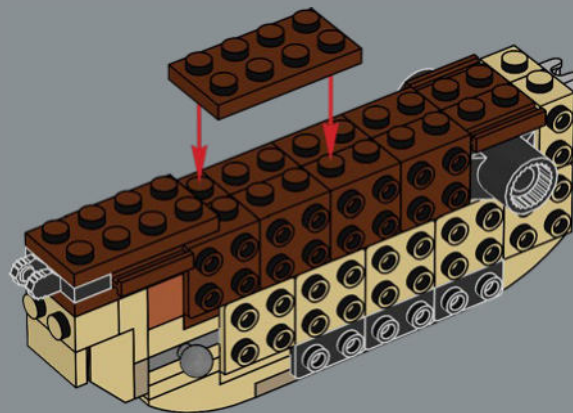

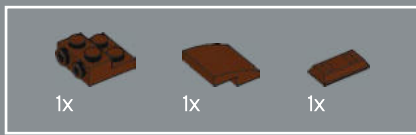

13

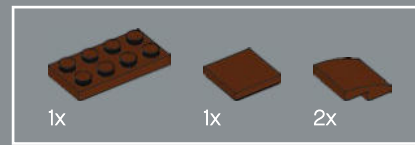
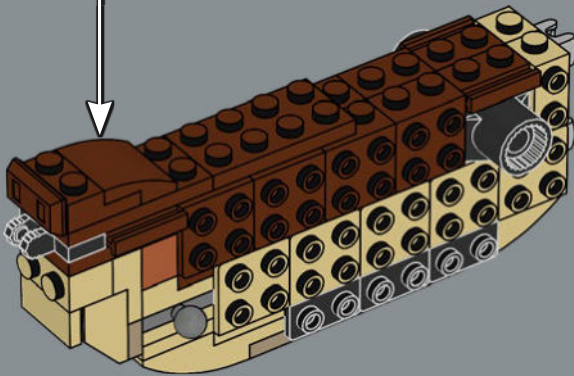
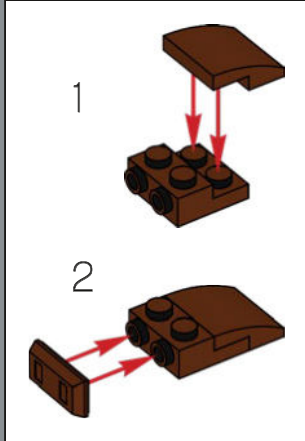

14

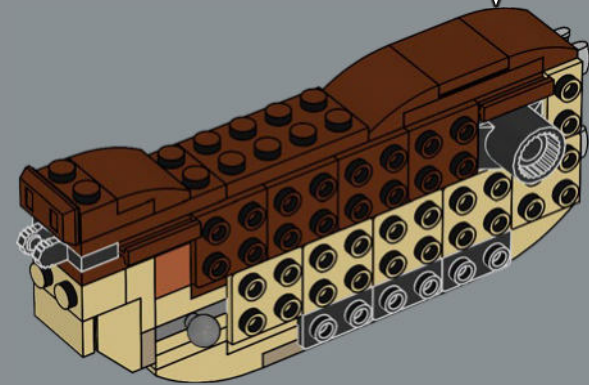
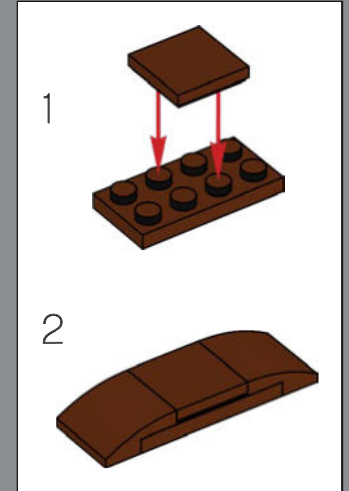

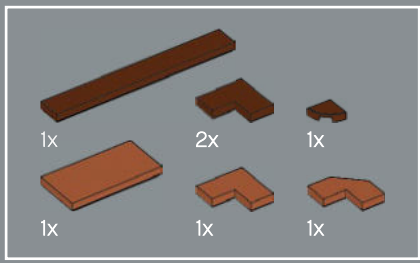

15

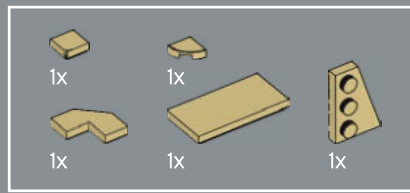
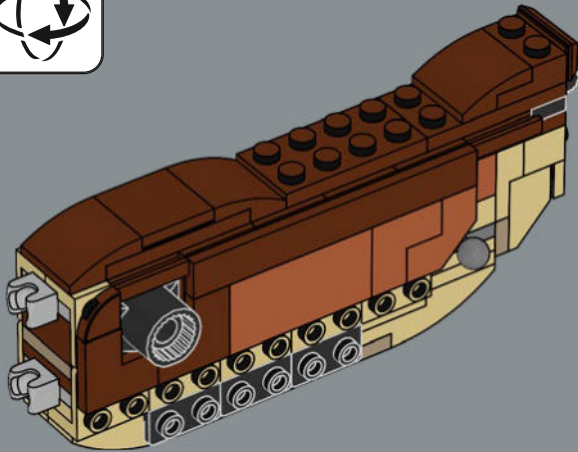

16

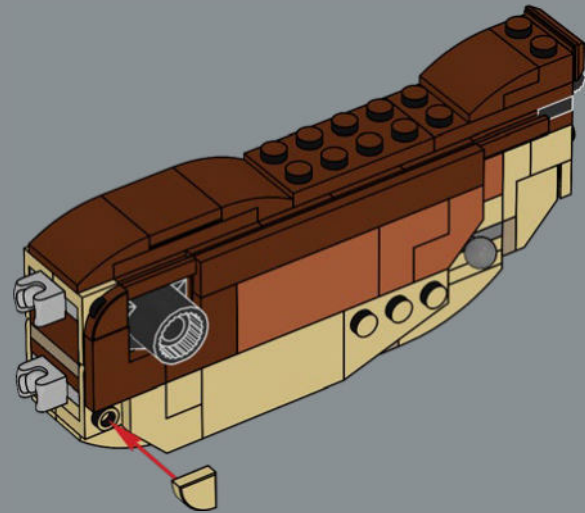

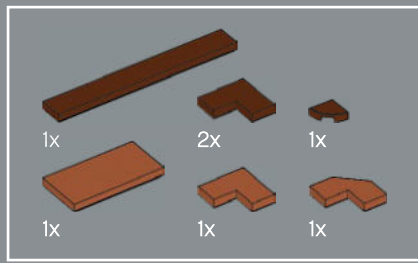

17

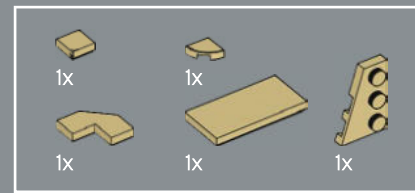
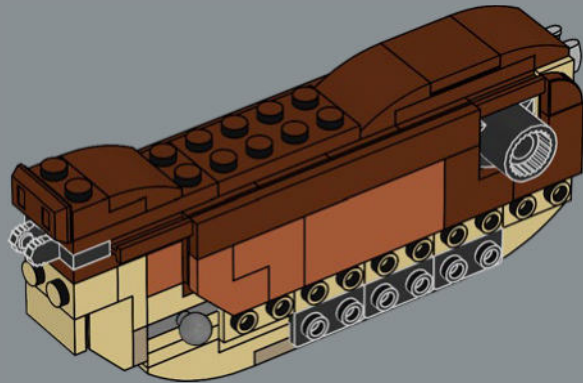

18

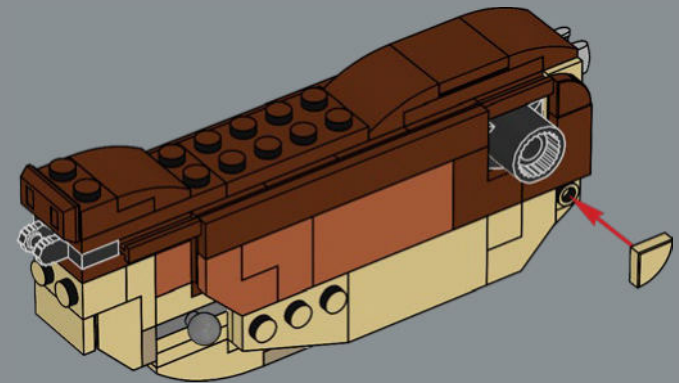

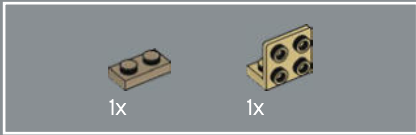

19

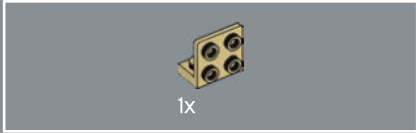

20

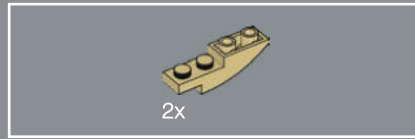

21

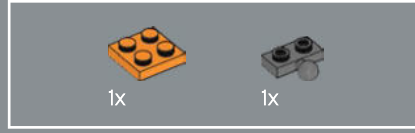
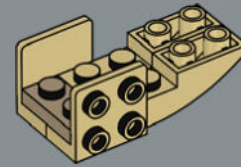

22

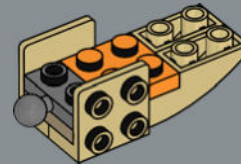



23

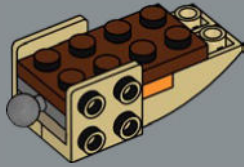

24

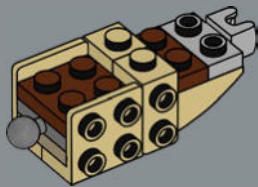

25

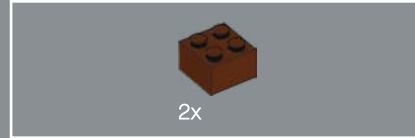
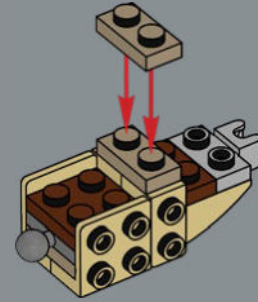

26

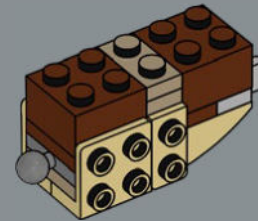



27

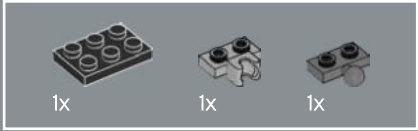
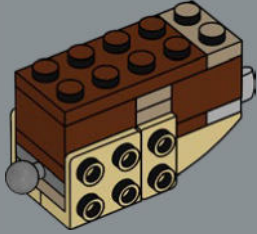

28

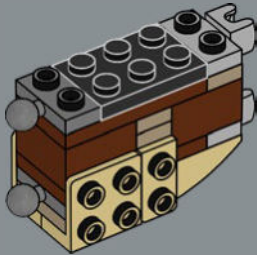

29

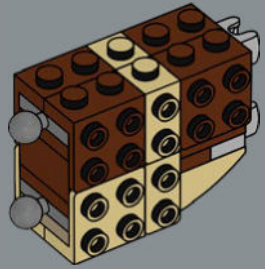

30

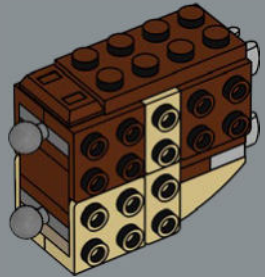

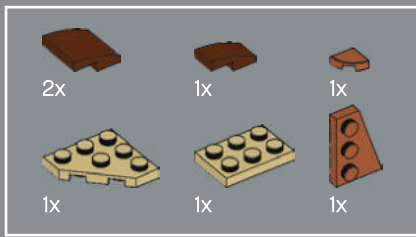

31

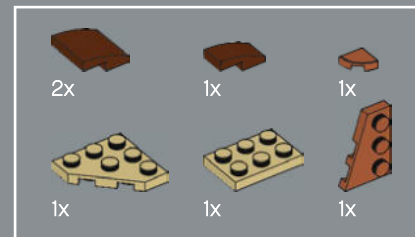
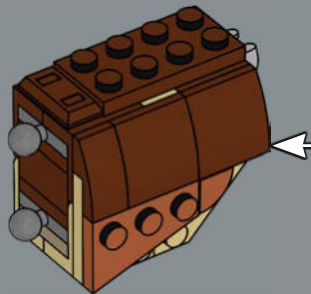
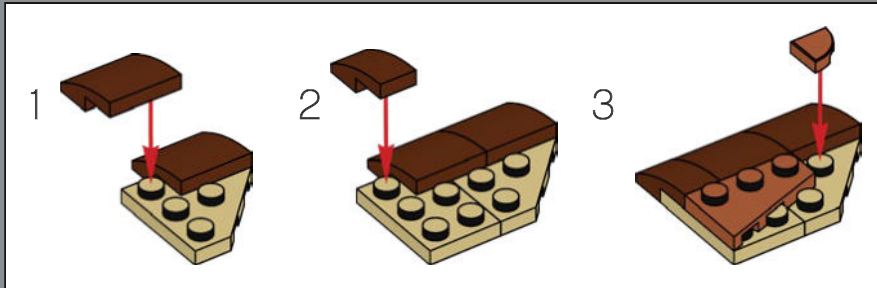

32

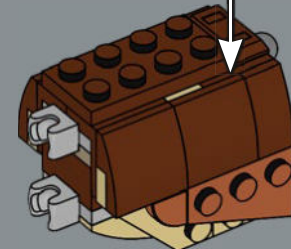
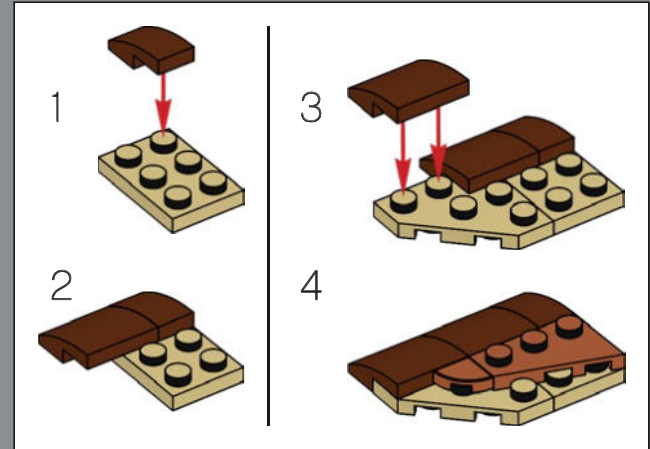

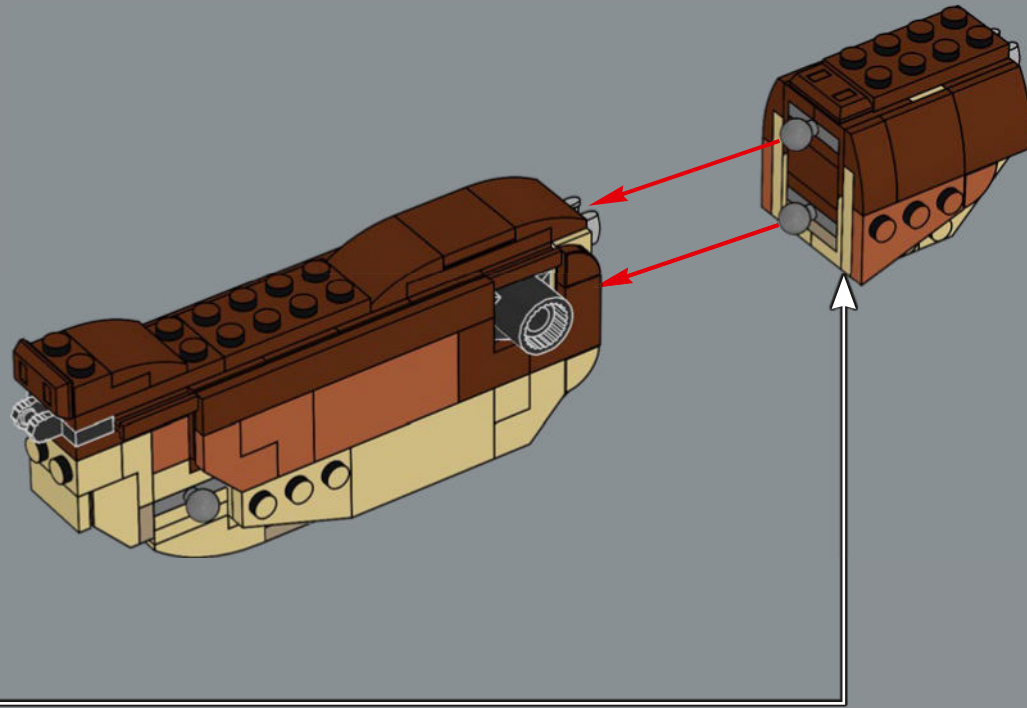



34

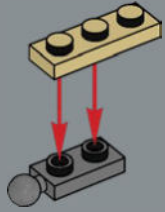

35

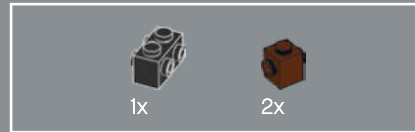
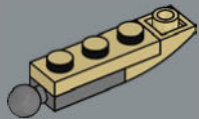

36

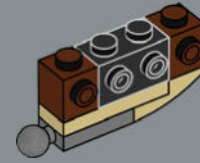

37

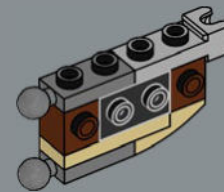



38

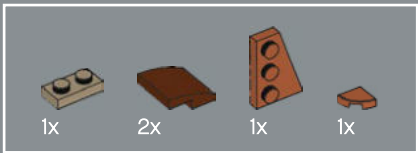
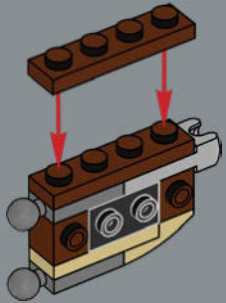

39

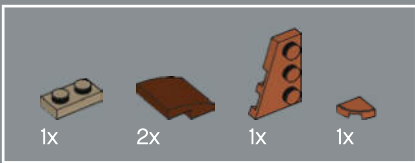
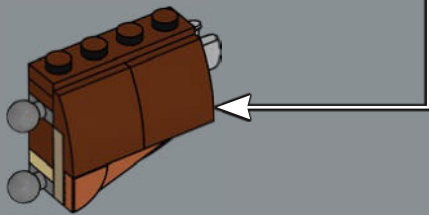
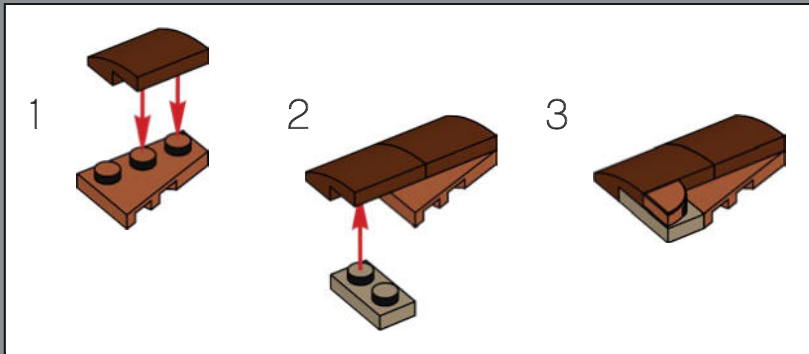

40

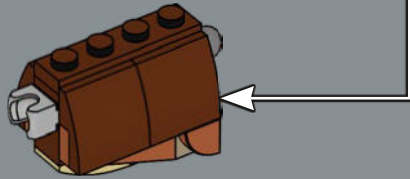
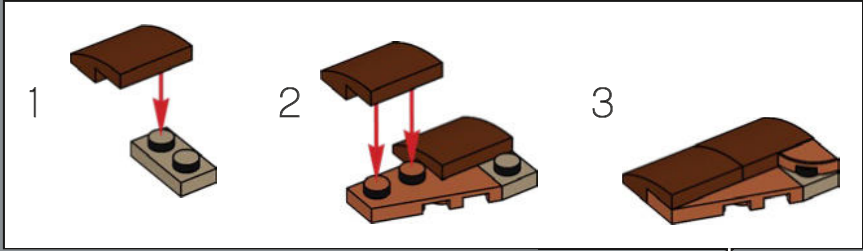

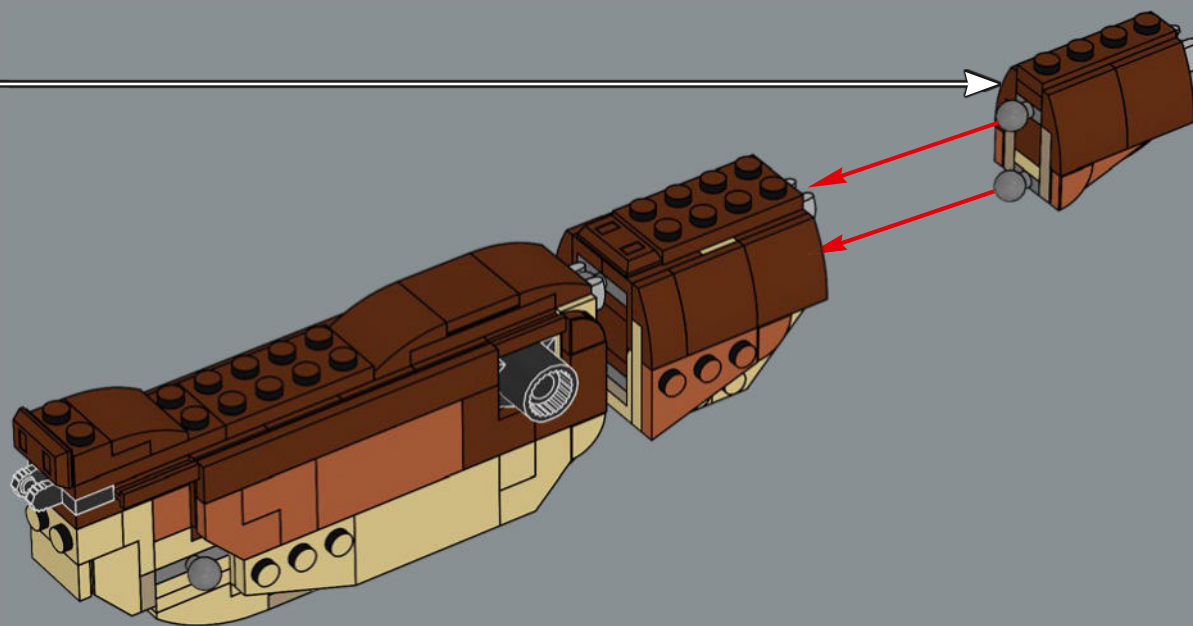

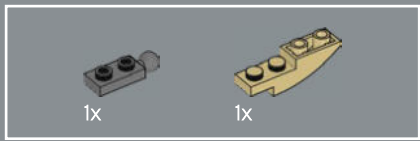

42

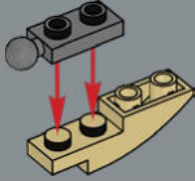

43

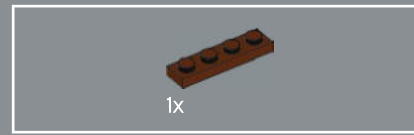
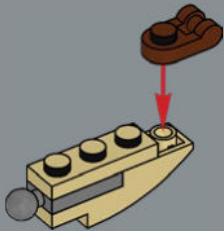

44

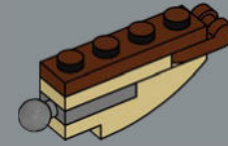

45

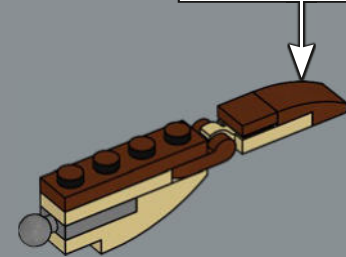
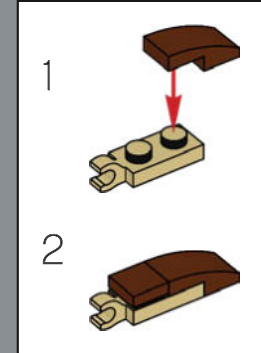

46

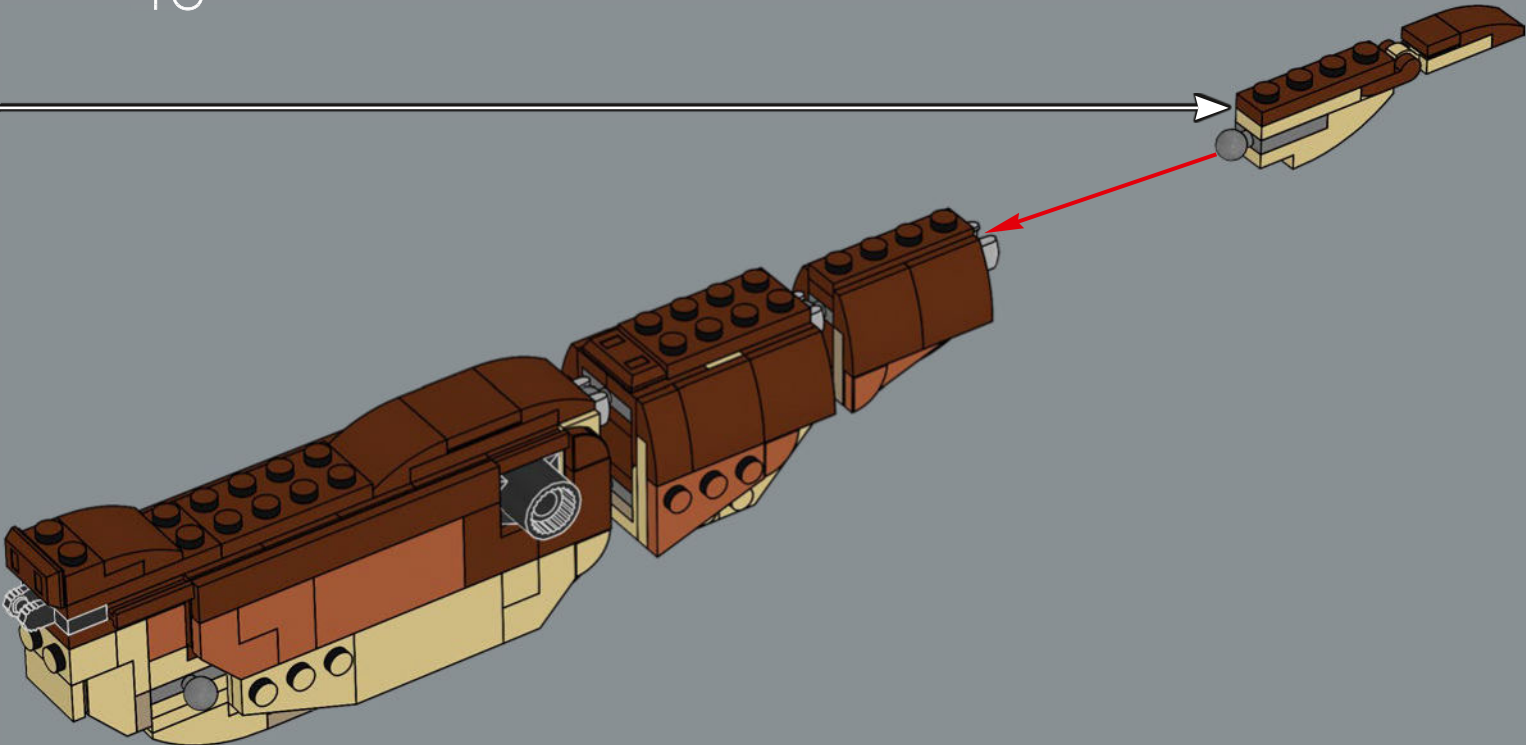

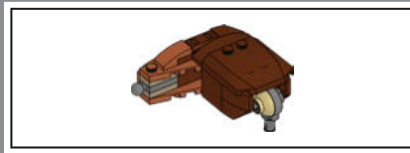
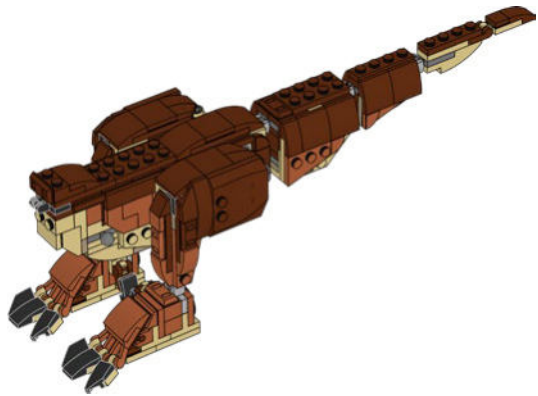
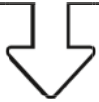

1x

1x

47

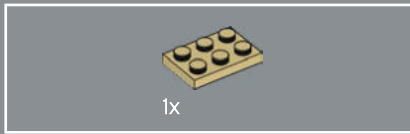
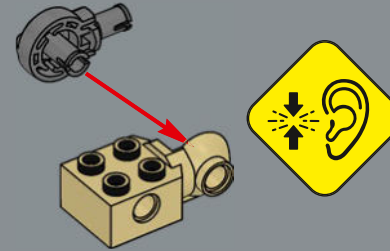

1x

48

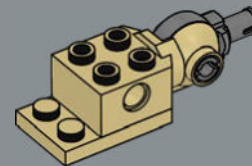

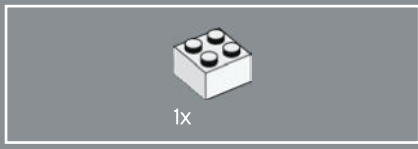

49

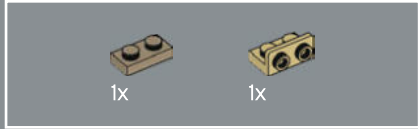
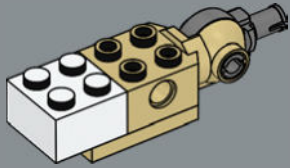

50

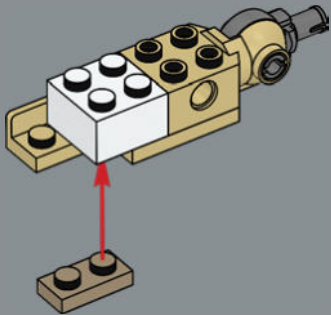

51

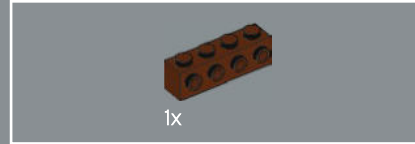
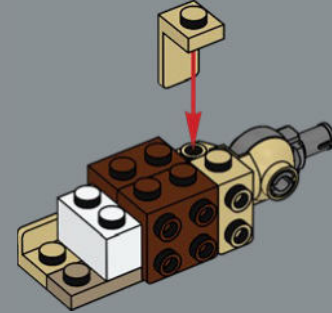

52

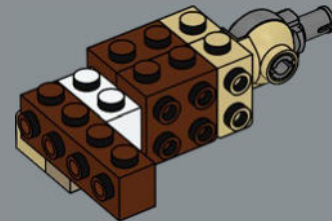

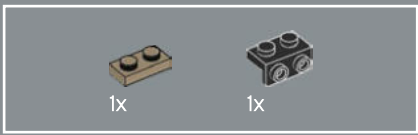

53

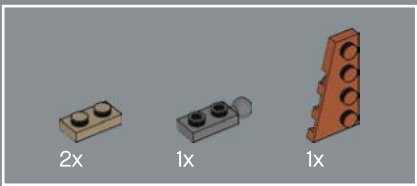
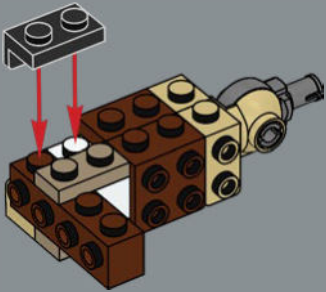

54

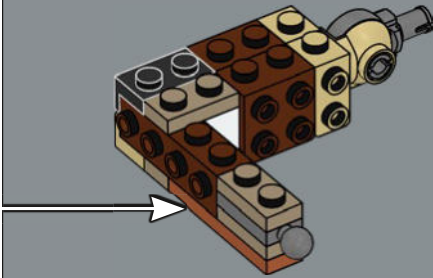
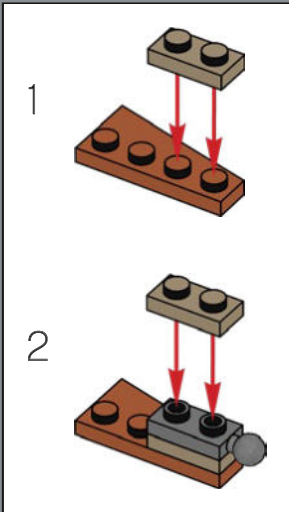



55

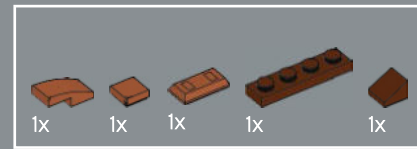
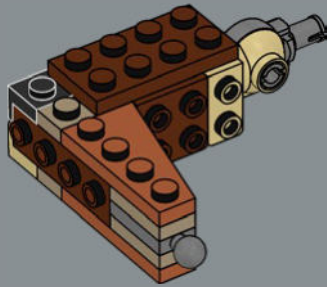

56

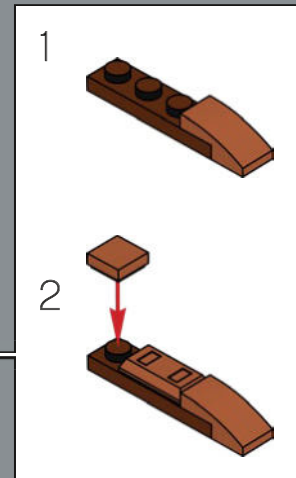
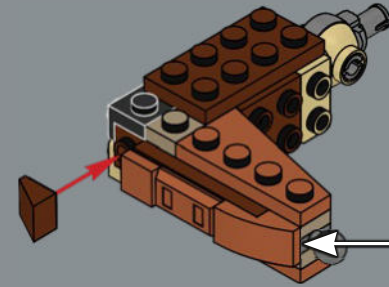

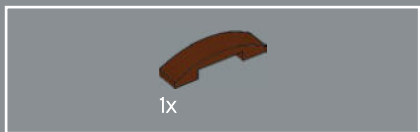

57

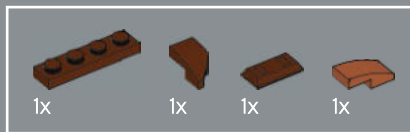
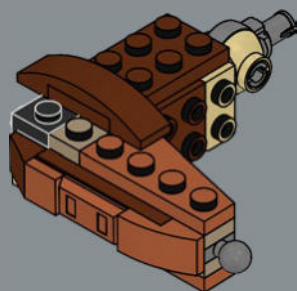

58

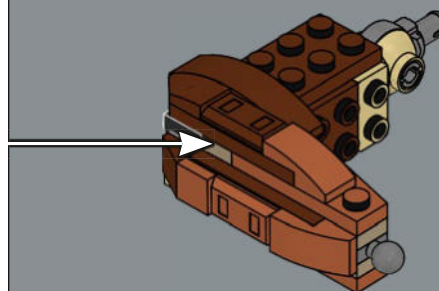
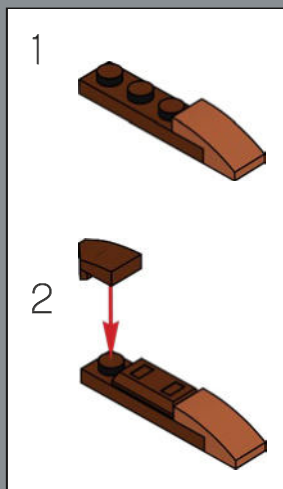

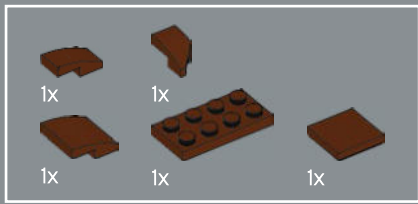

59

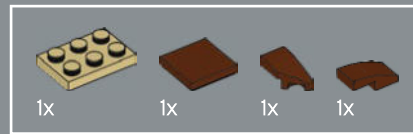
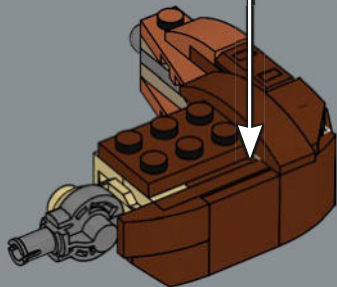
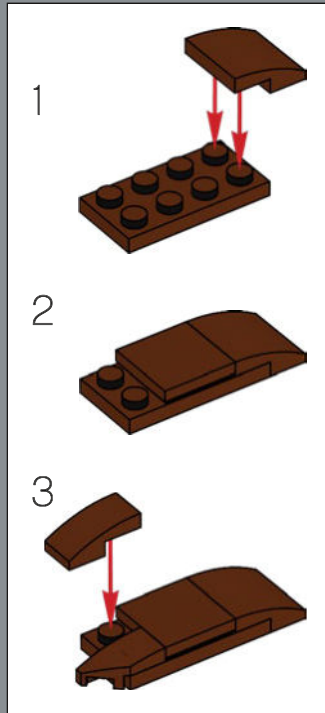

60

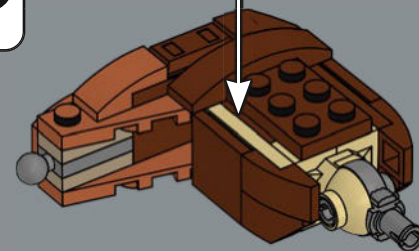
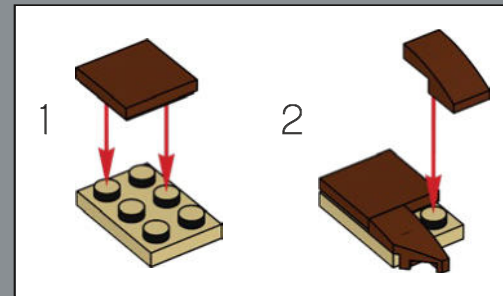

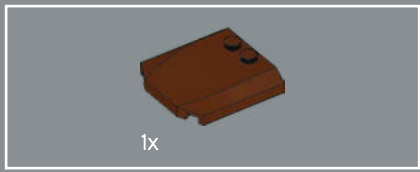

61

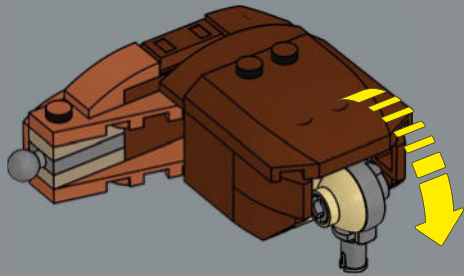

62

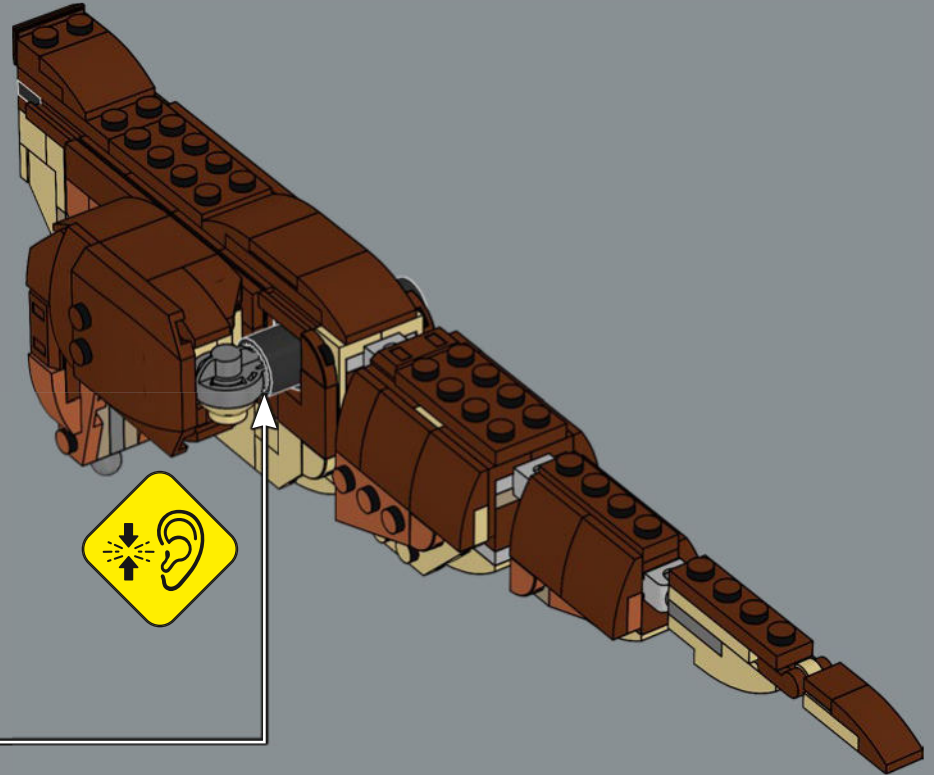

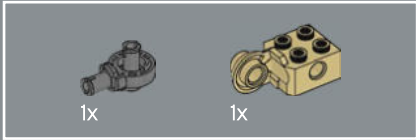

63

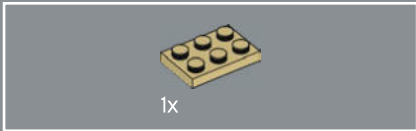
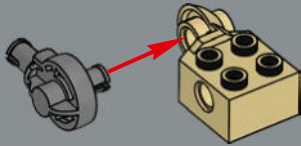

64

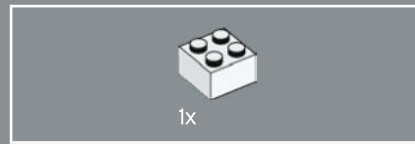
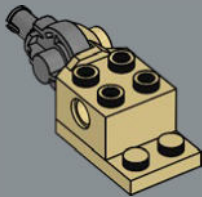

65

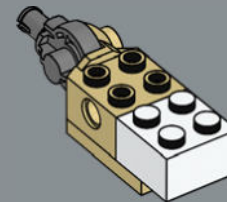

66

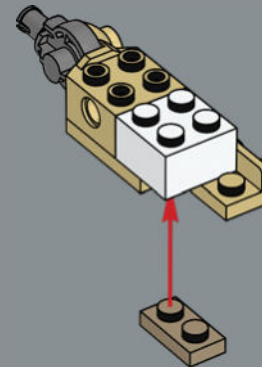



67

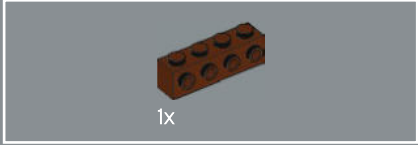
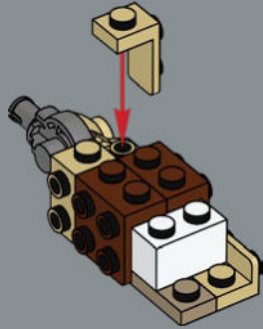

68

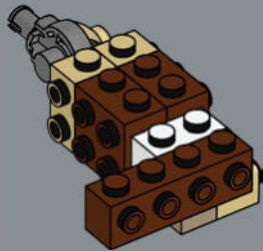

69

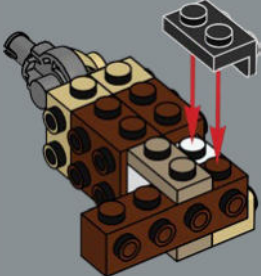

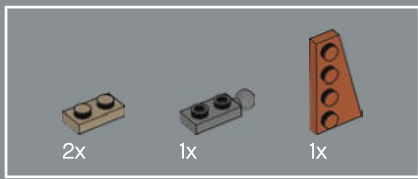

70

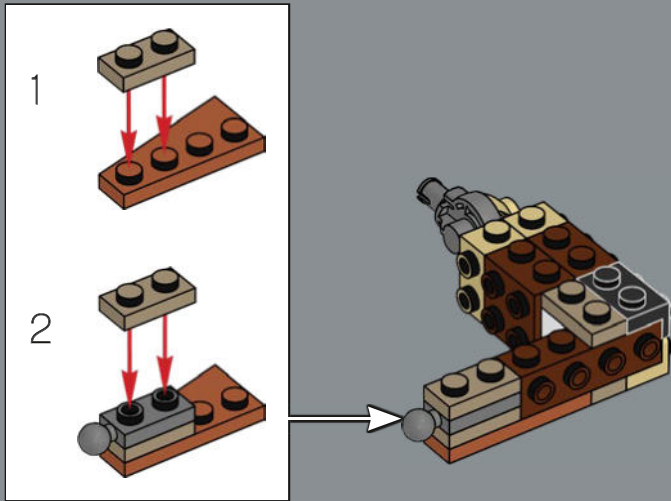

71

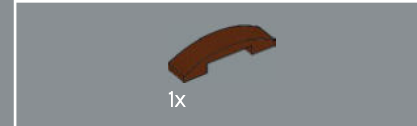
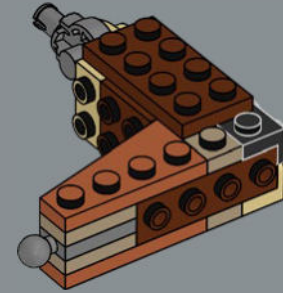

72

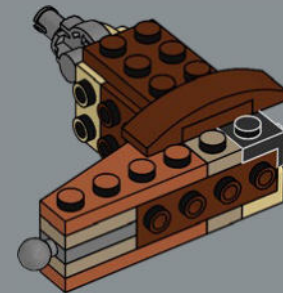

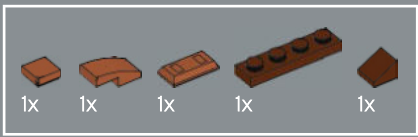

73

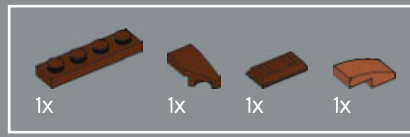
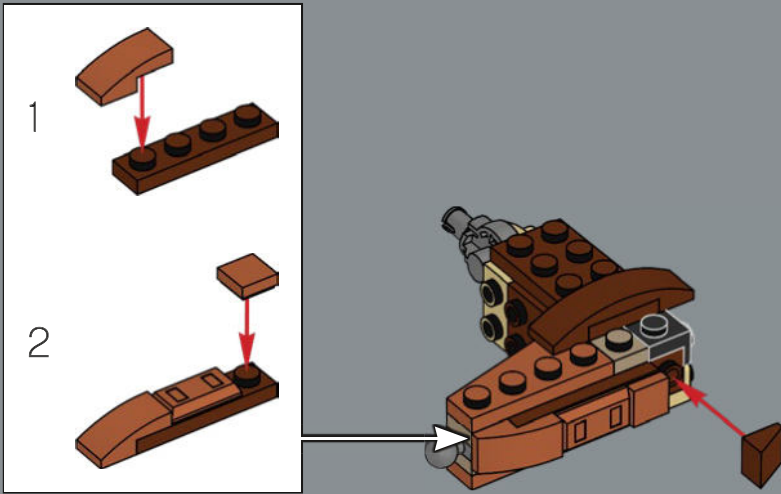

74

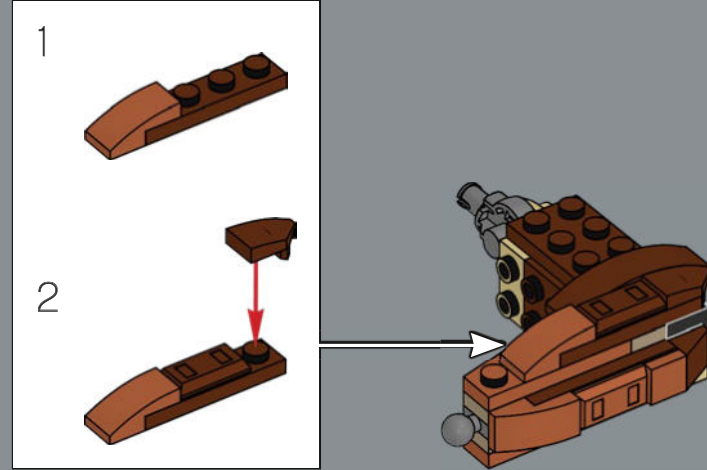

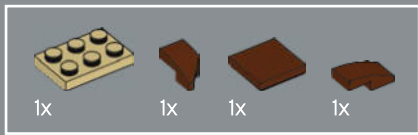

75

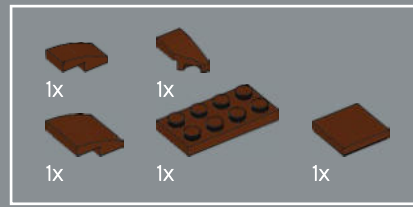
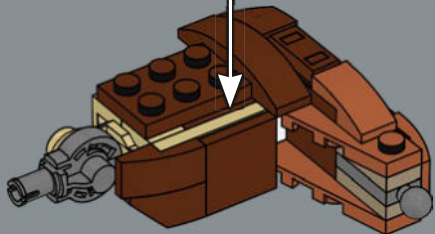
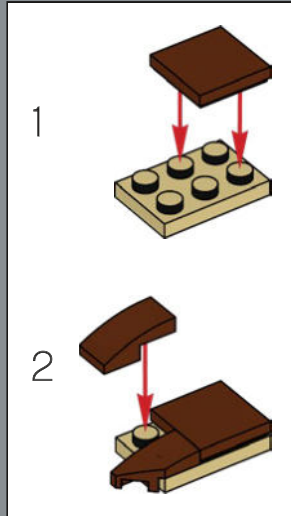

76

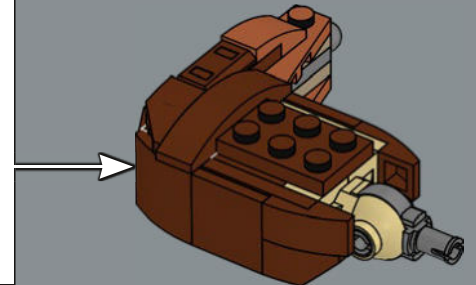
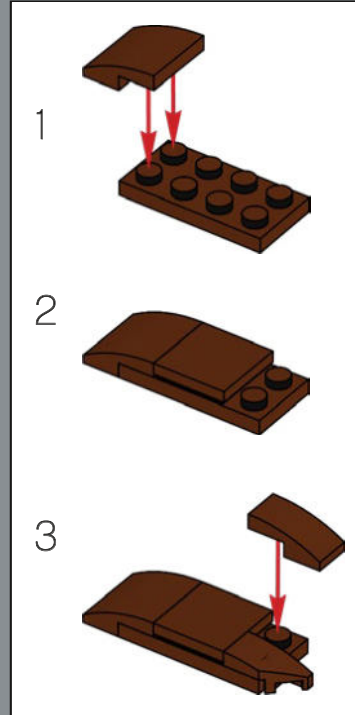

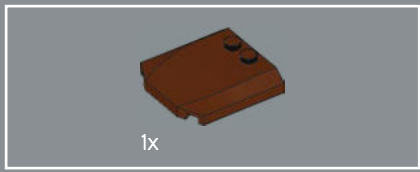

77

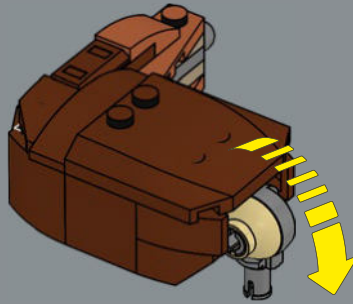

78

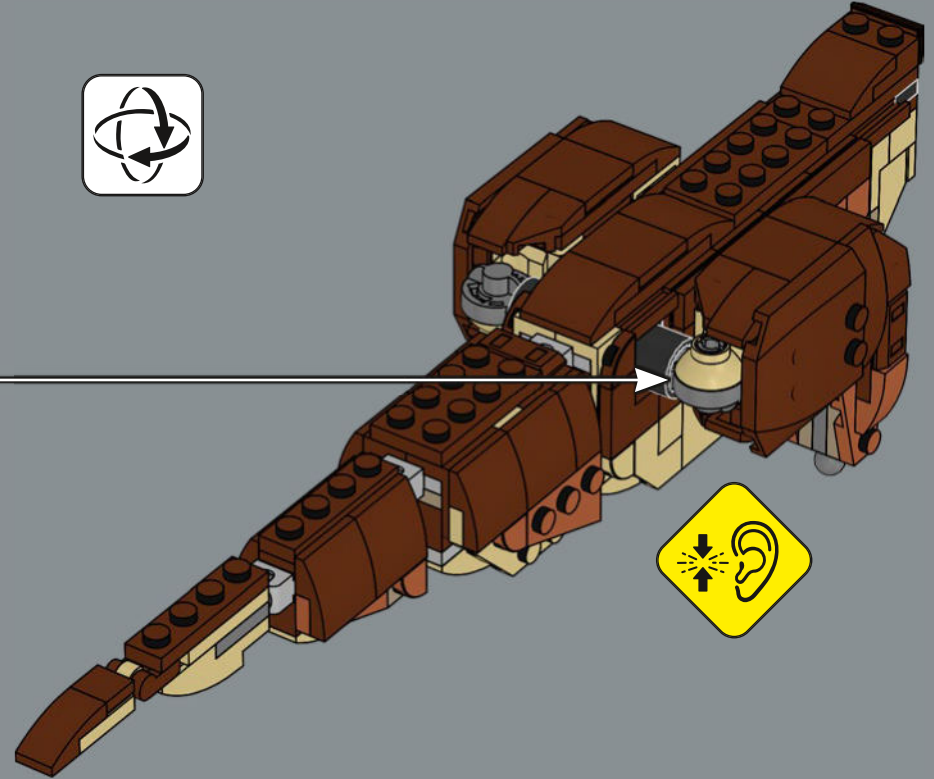

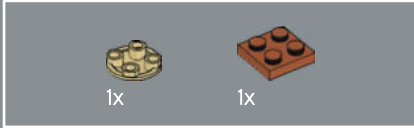
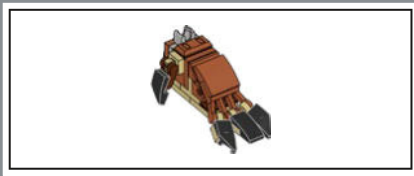

79

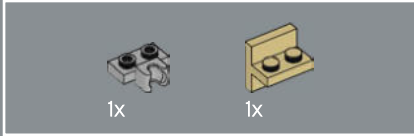
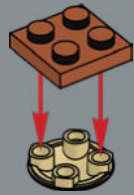

80

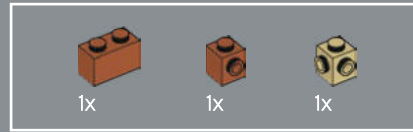
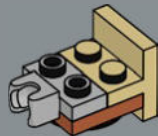

81

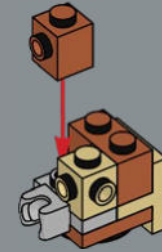

82

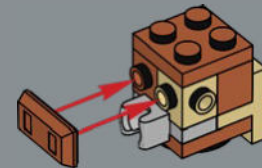

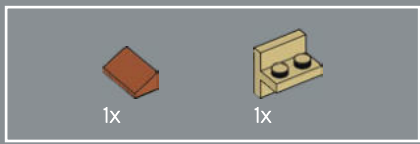

83

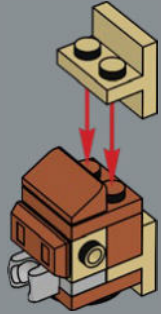

84

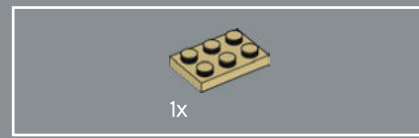
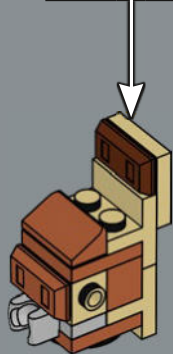
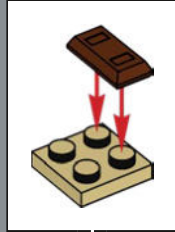

85

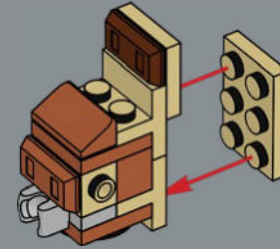

86

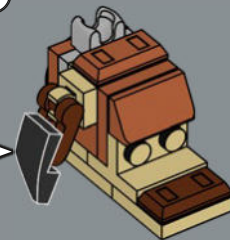
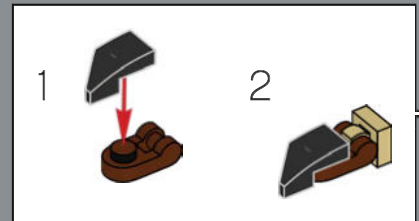

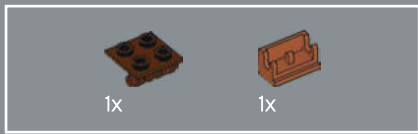

87

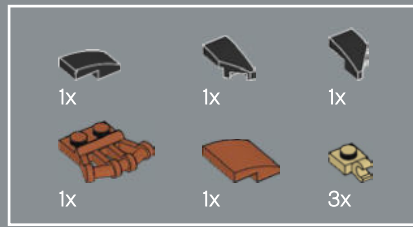
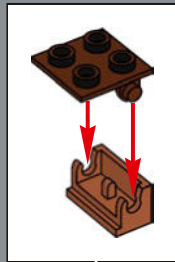

88

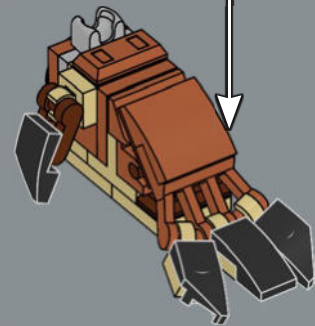

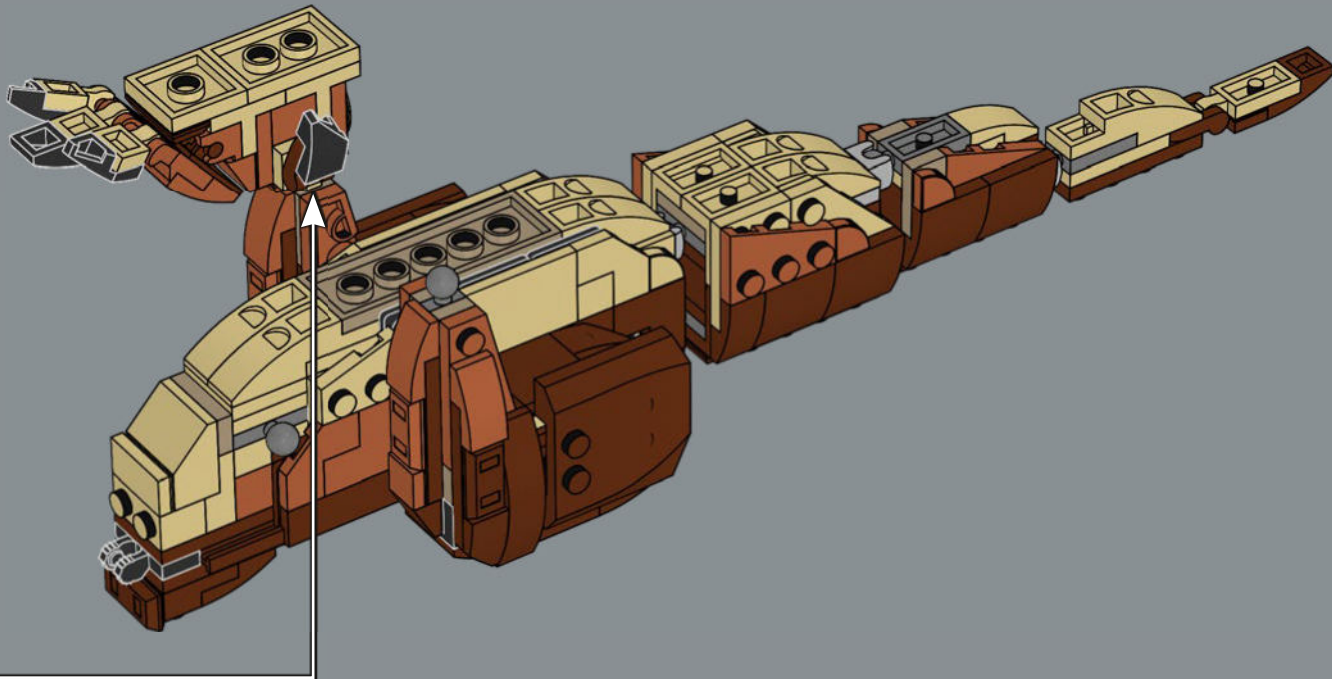



90

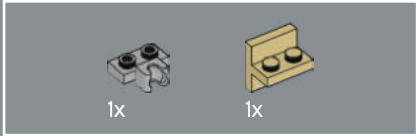
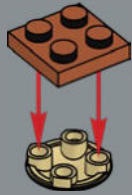

91

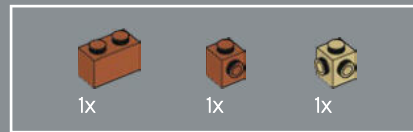
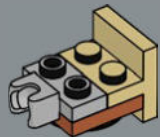

92

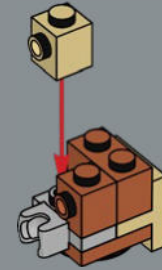

93

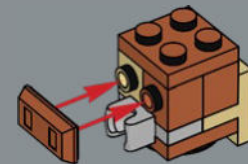

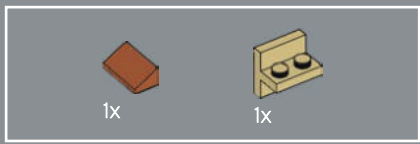

94

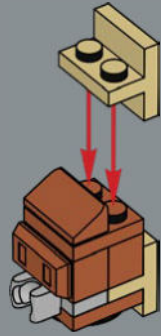

95

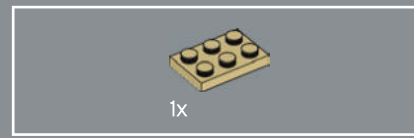
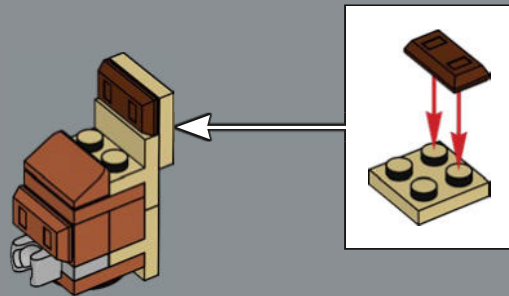

96

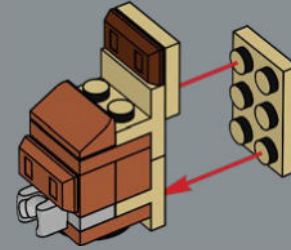

97

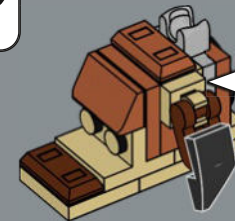
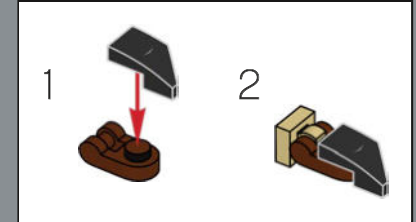



98

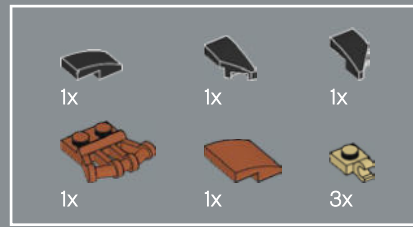
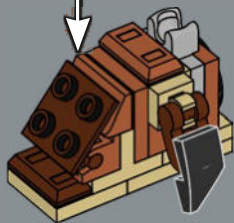
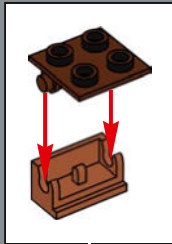

99

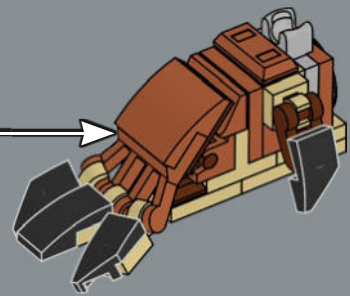
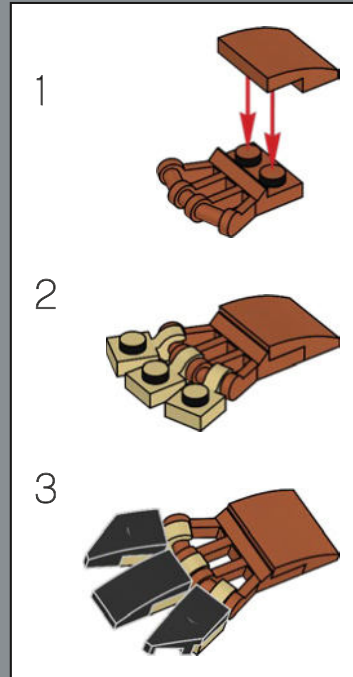

100

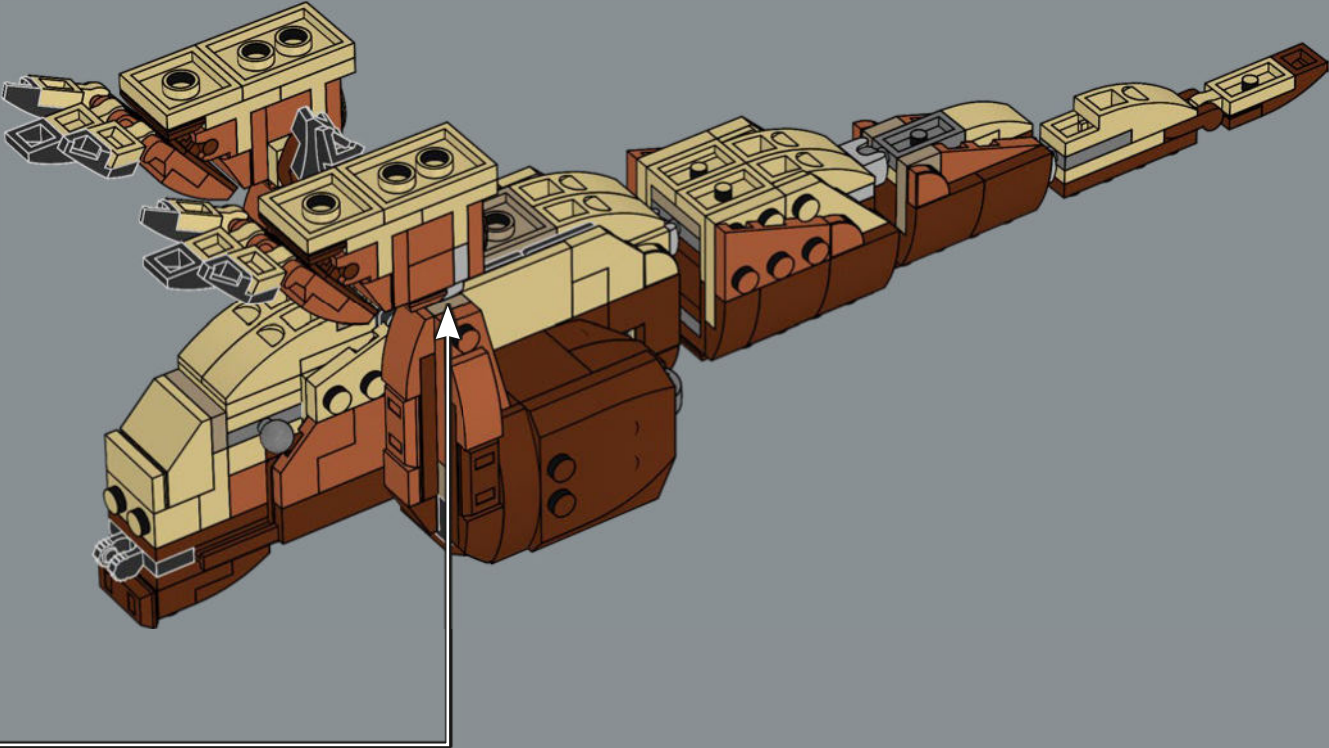

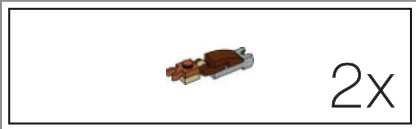
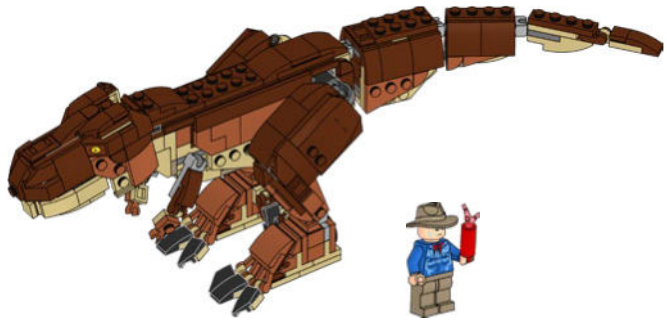
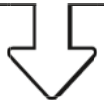

101

1



2



3

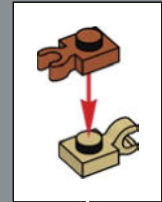

2x

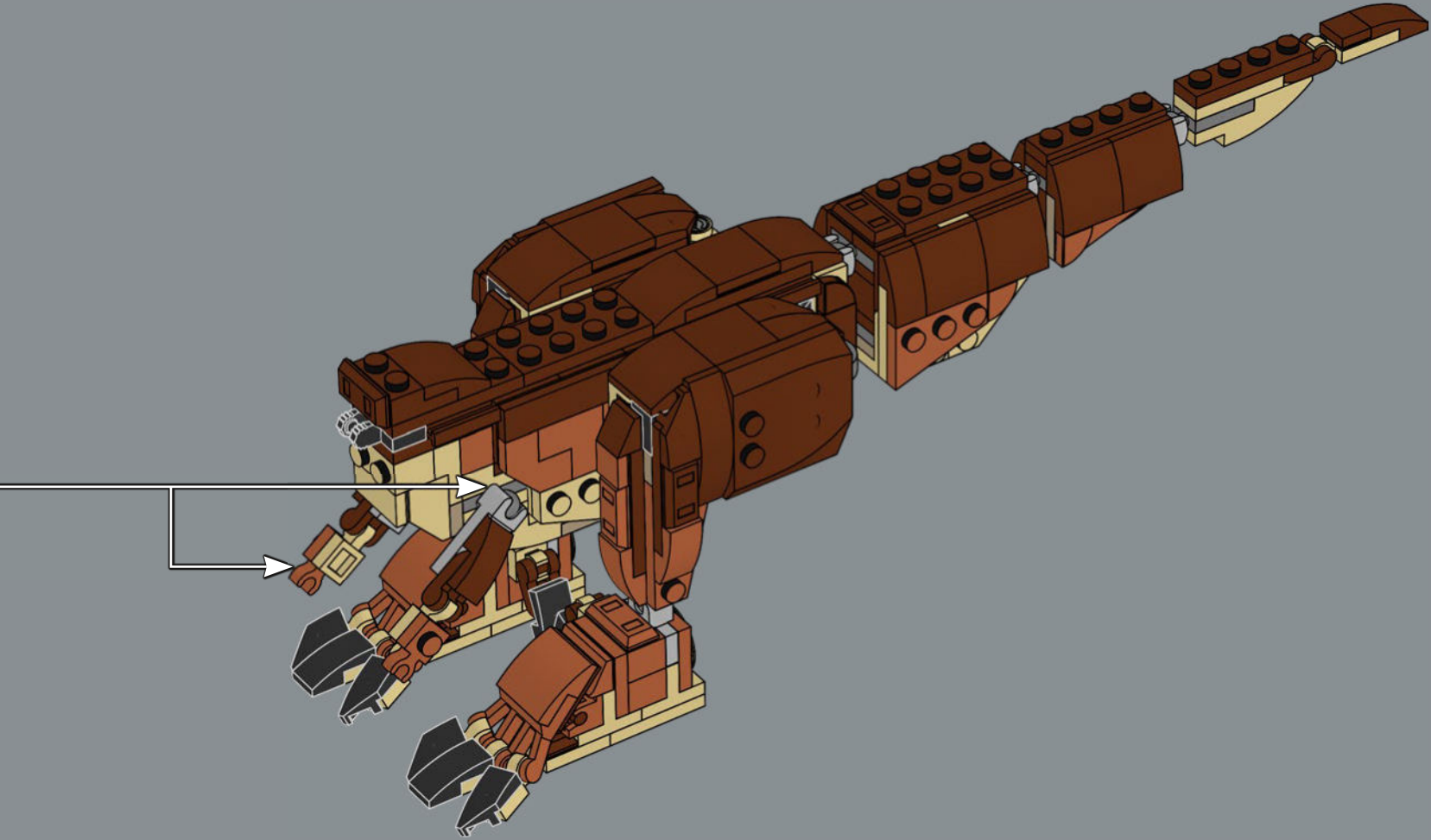

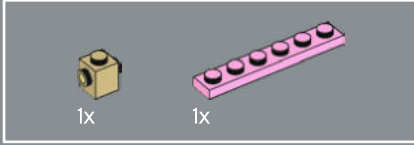
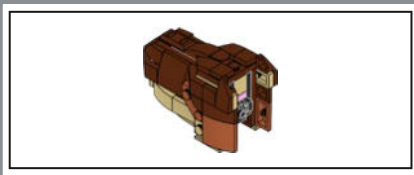

102

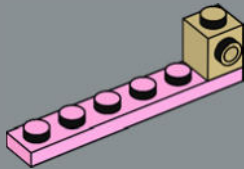

103

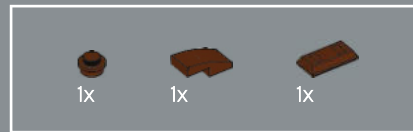
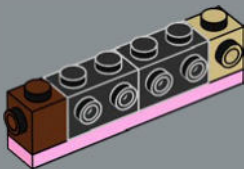

104

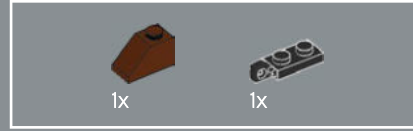
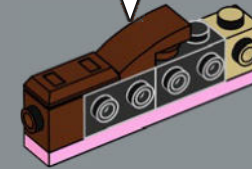
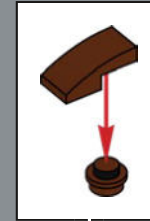

105

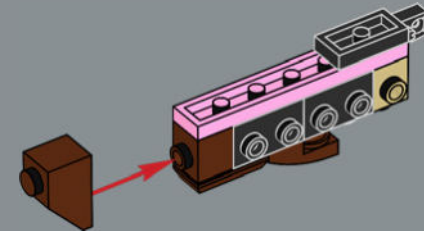



106

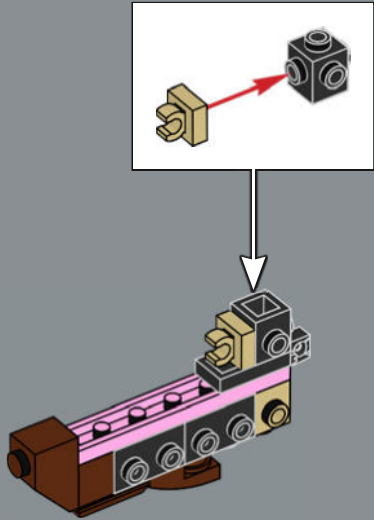

107

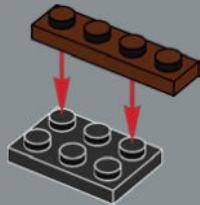

108

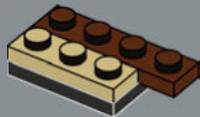



109

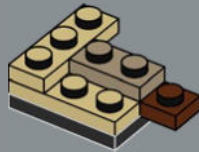

110

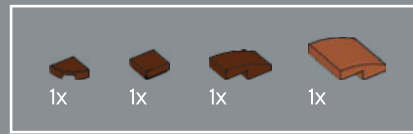
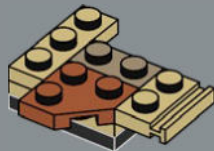

111

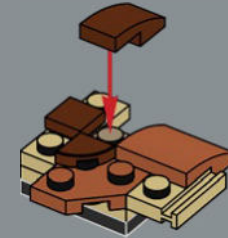

112

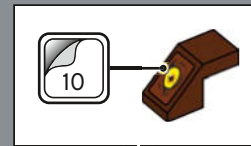

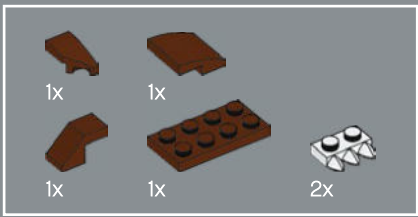

113

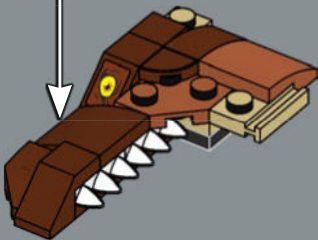
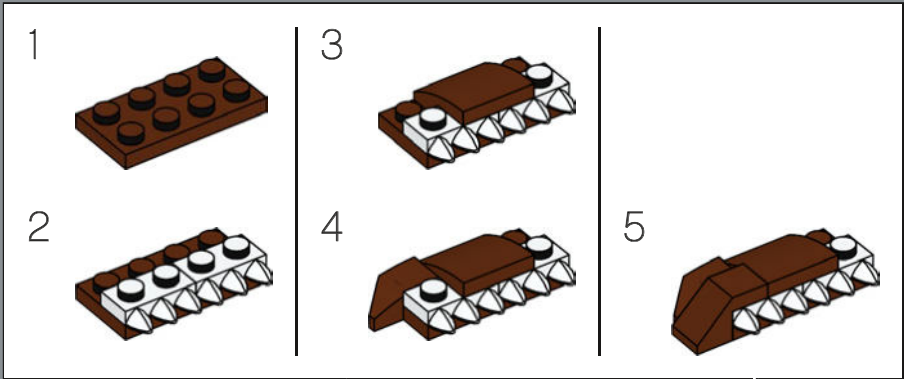

114

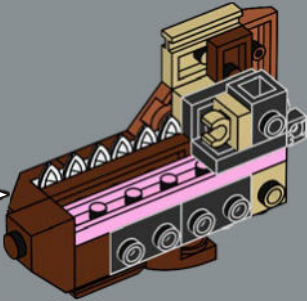



115

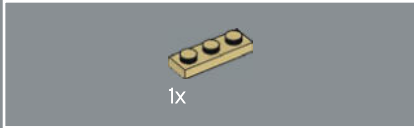
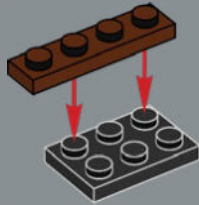

116

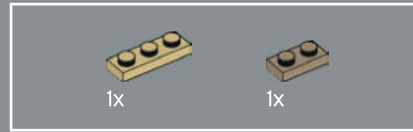
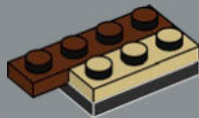

117

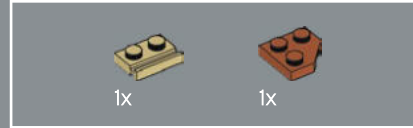
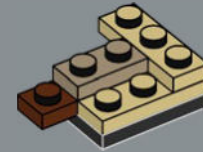

118

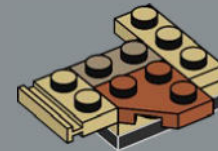

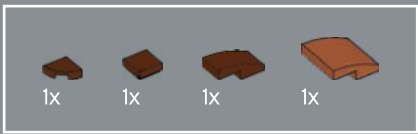

119

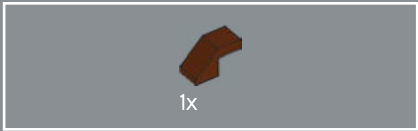
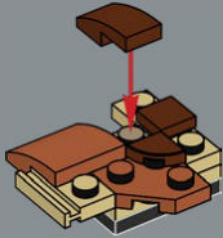

120

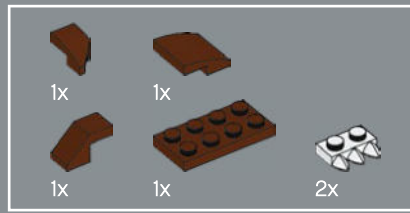
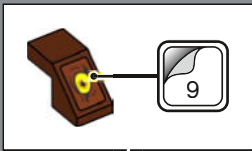

121

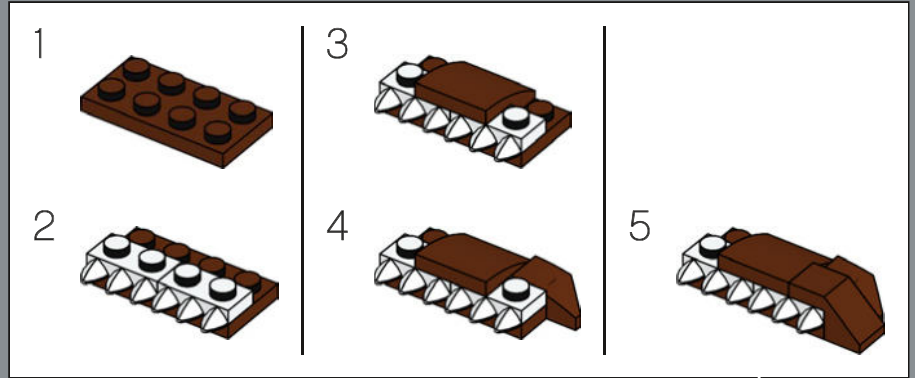

122

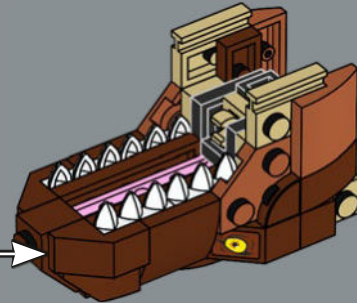

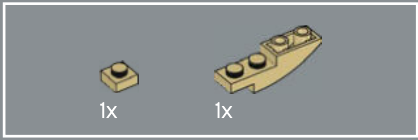

123

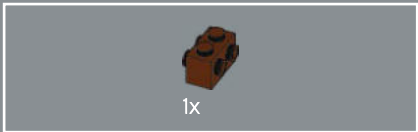
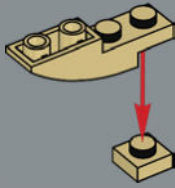

124

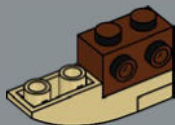

125

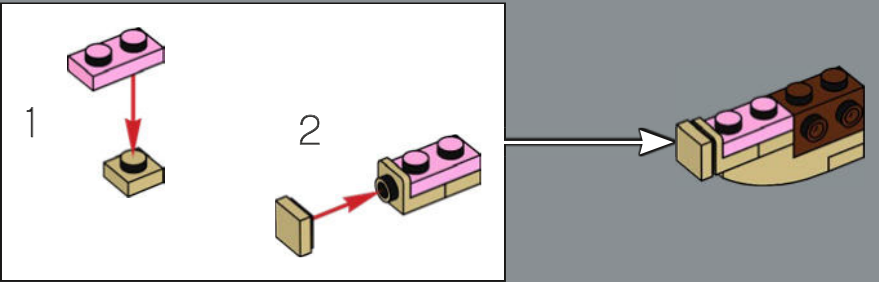

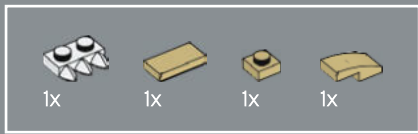

126

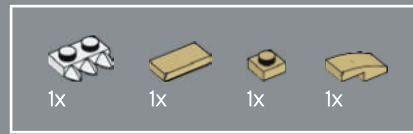
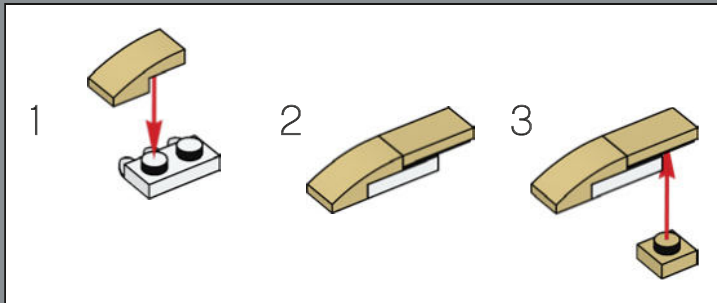

127

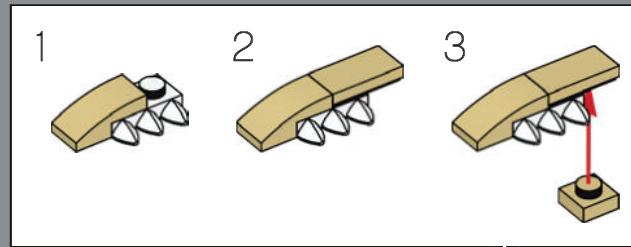



128

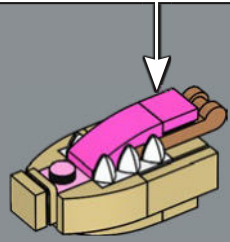
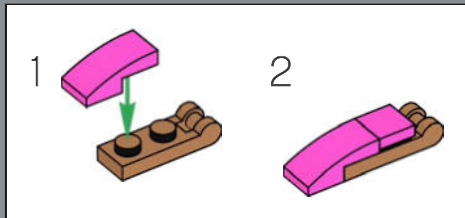

129

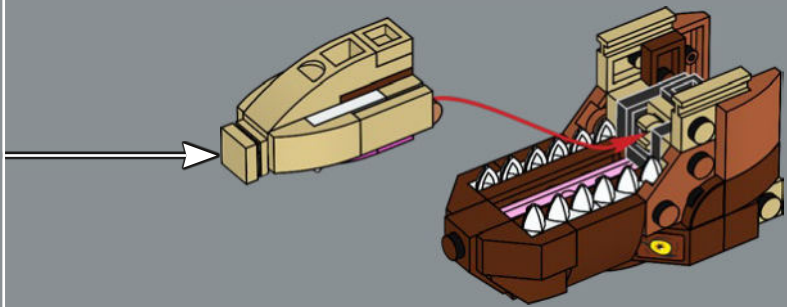

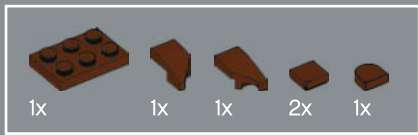

130

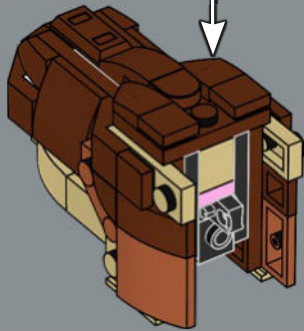
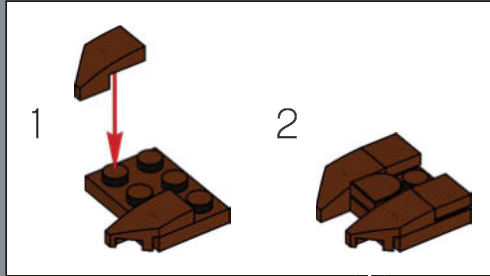

131

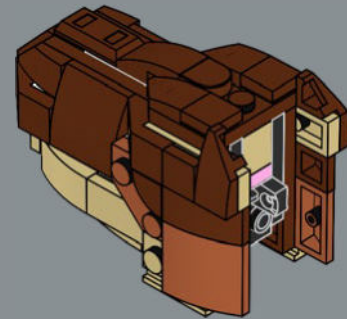

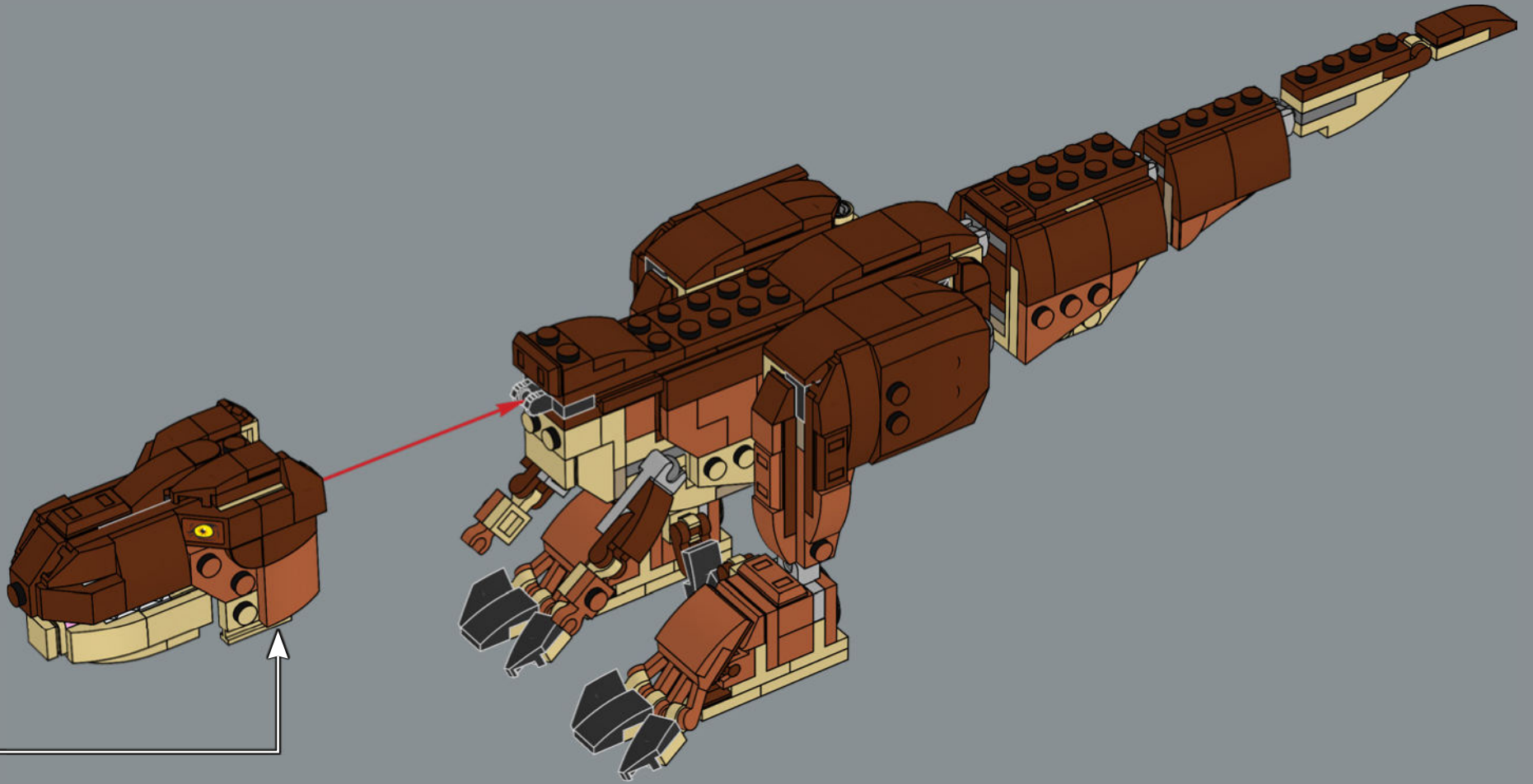

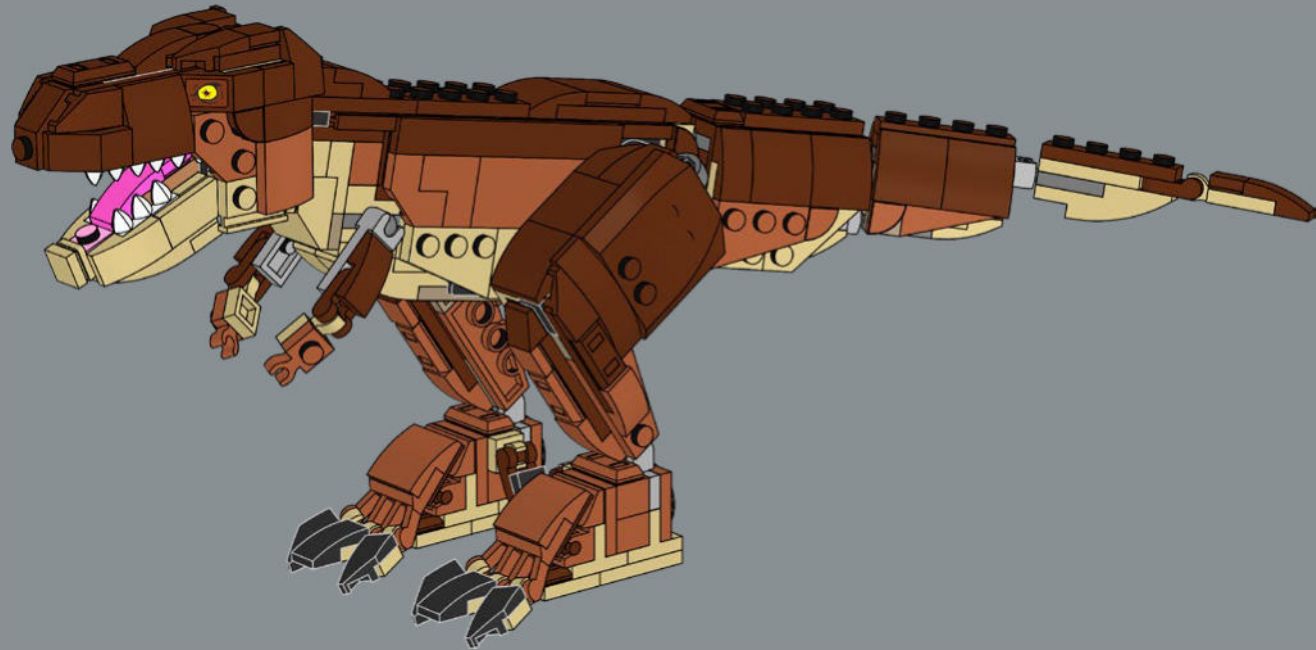

THE KING OF THE TYRANT LIZARDS

Back in 1993, audiences had never seen anything like it, a 13 m (44 ft.)-tall, life-like apex predator. Achieved through ground-breaking animatronics, complemented by a small amount of CGI, the result is a creation that still very much stands the test of time.

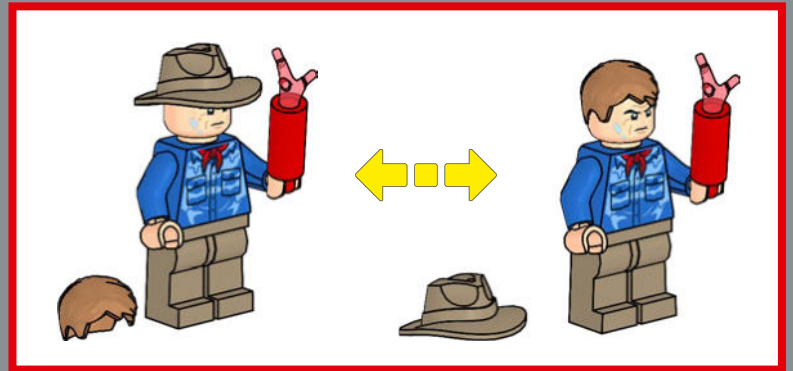
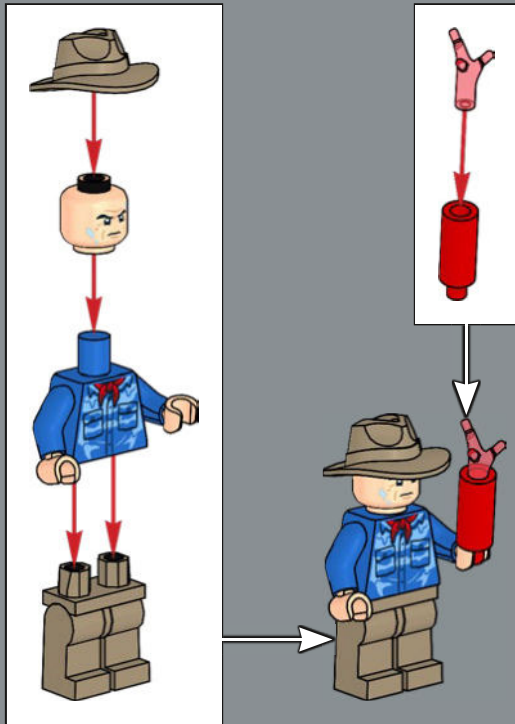



FETCH, REXY!

With Lex and Tim trapped underneath the flipped car, it takes the quick thinking of Dr. Grant to save the day. He lights a flare and tosses it back towards the paddock, distracting the T. rex and giving the kids a chance to escape.

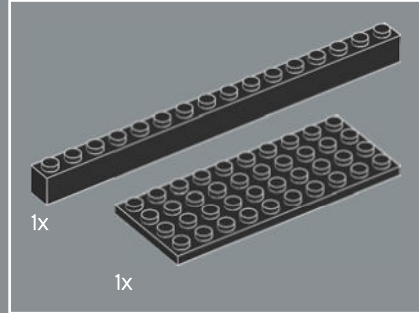
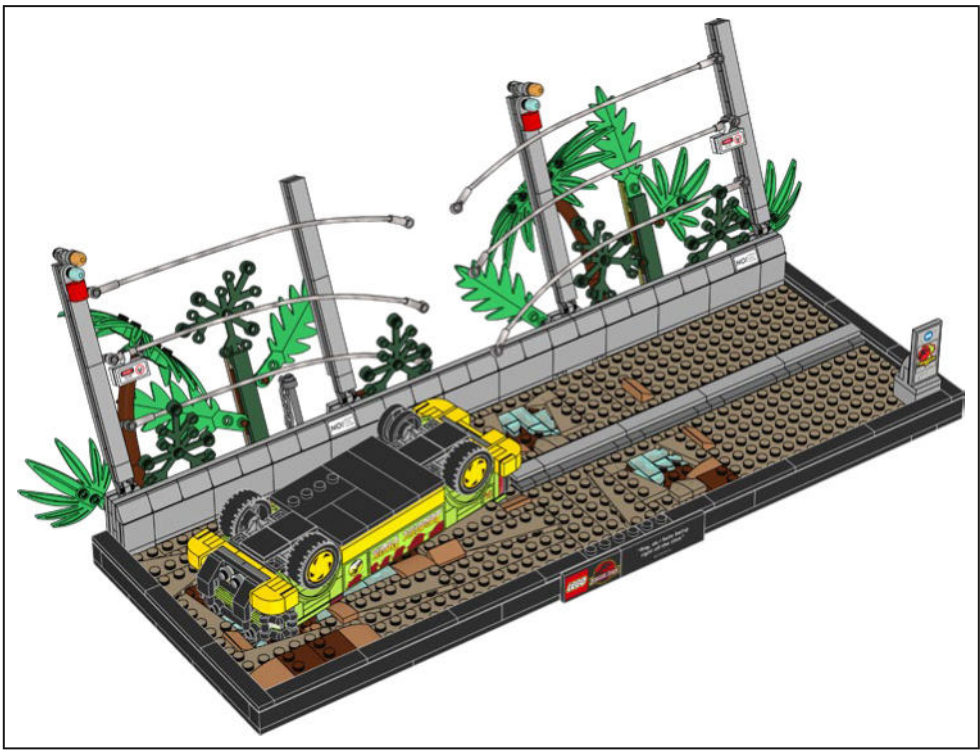
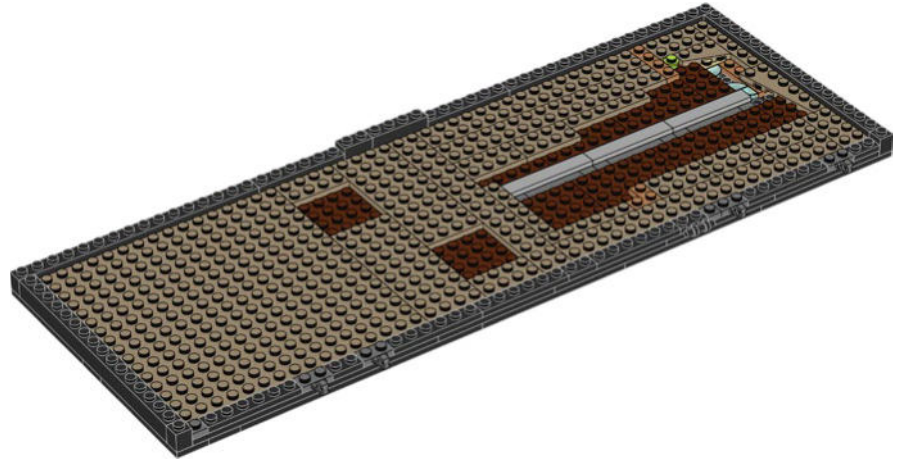
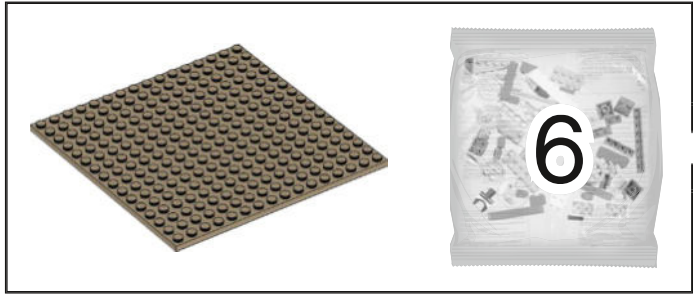

1

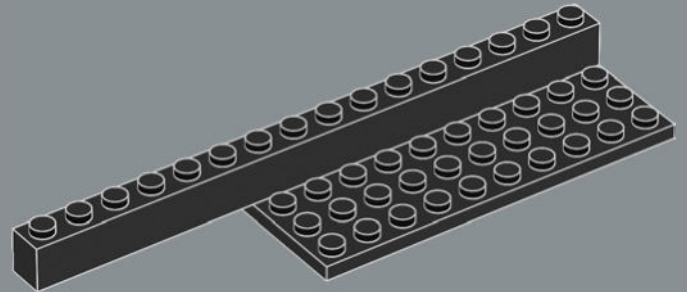

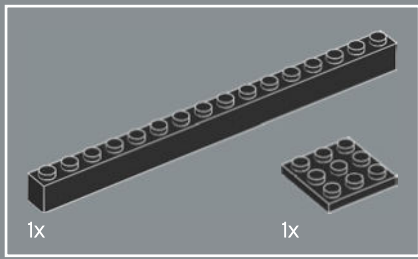

2

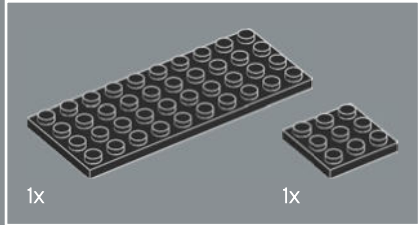
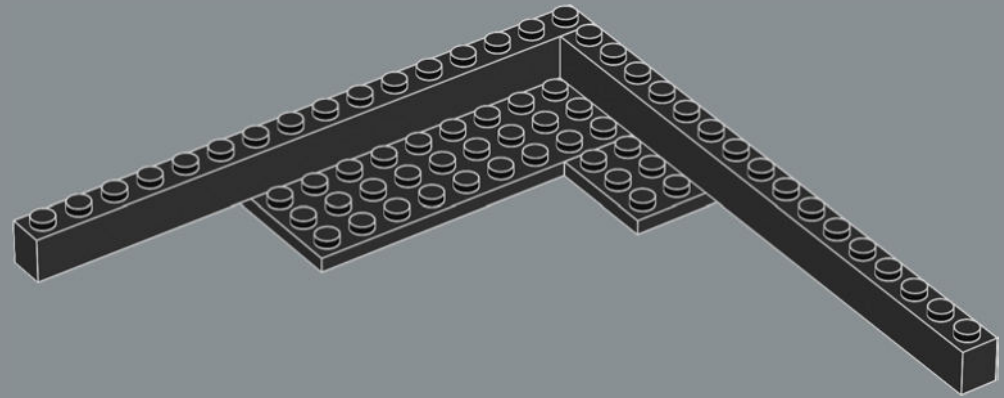

3

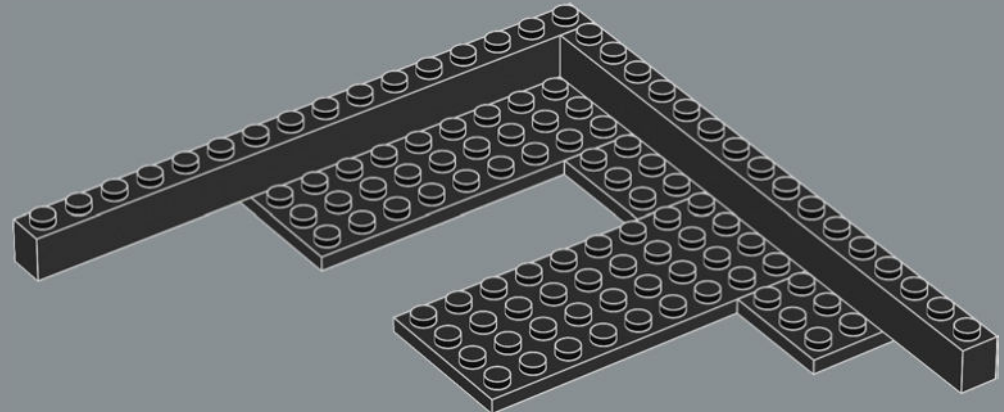

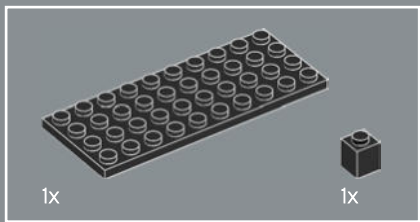

4

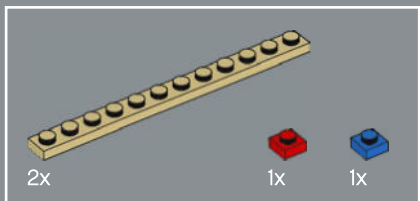
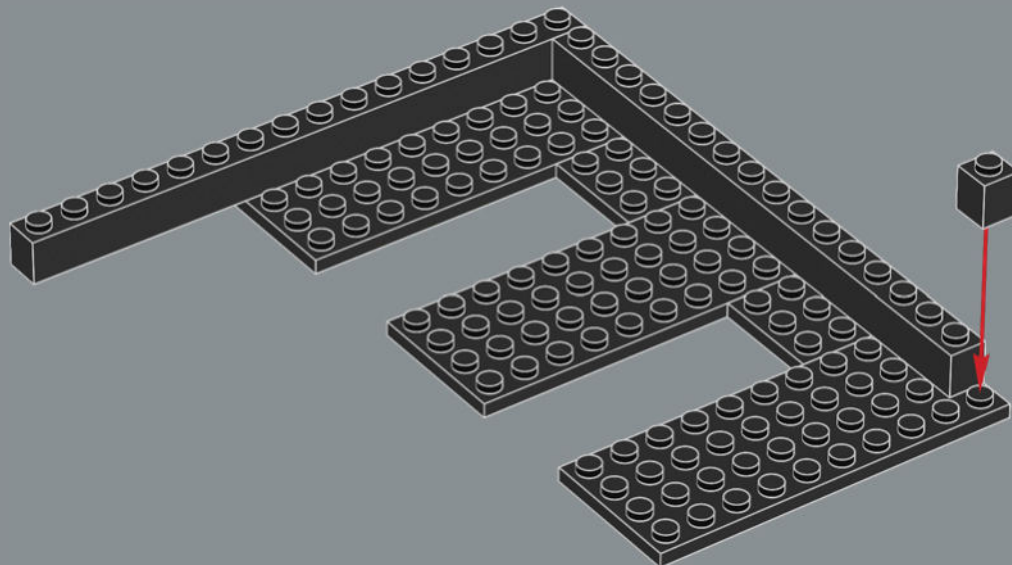

5

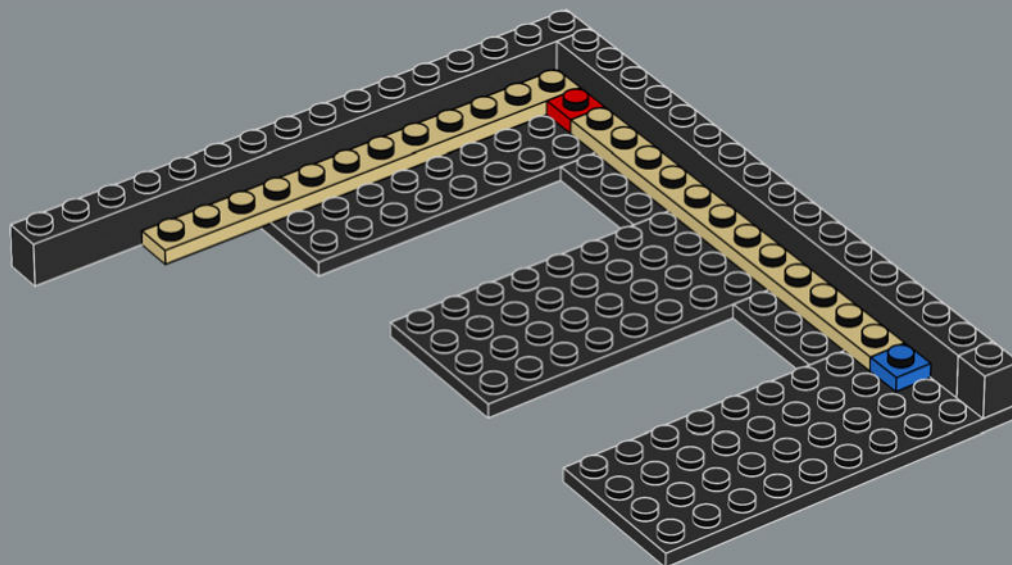

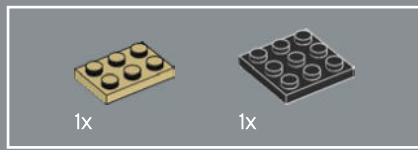

6

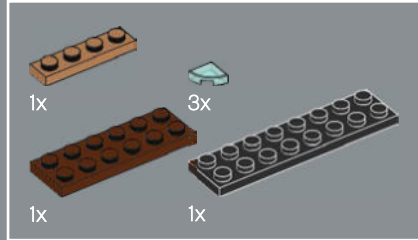
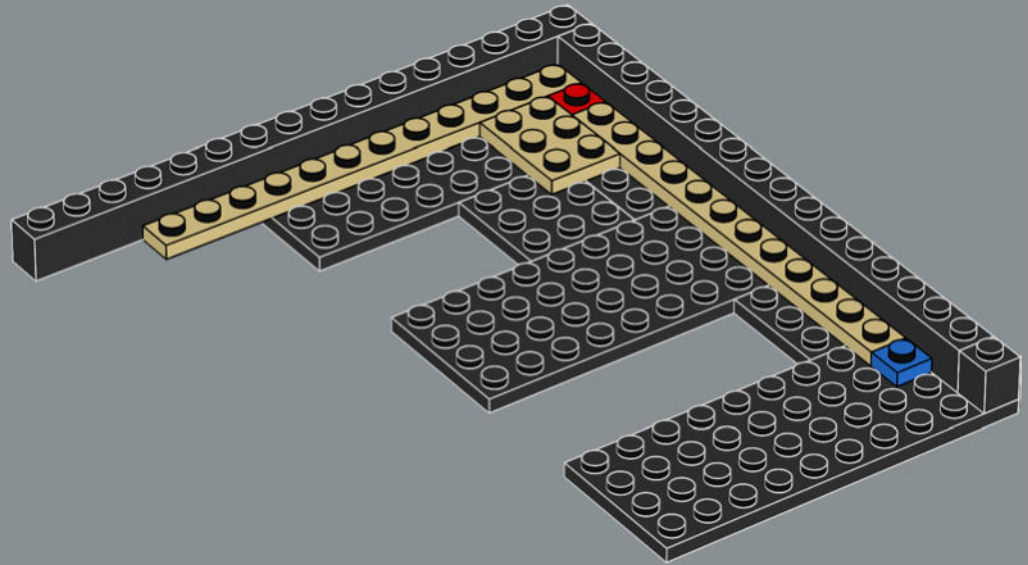

7

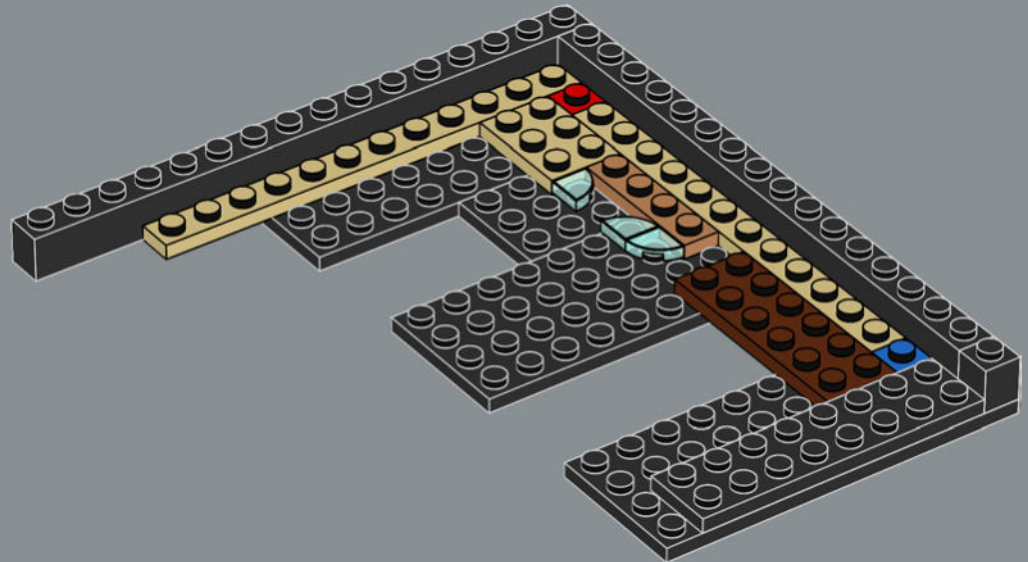

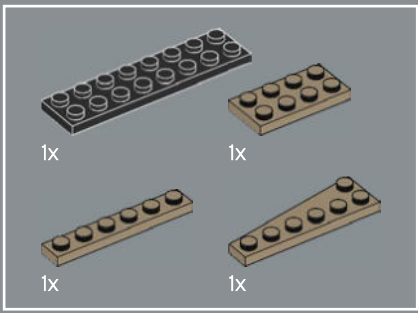

8

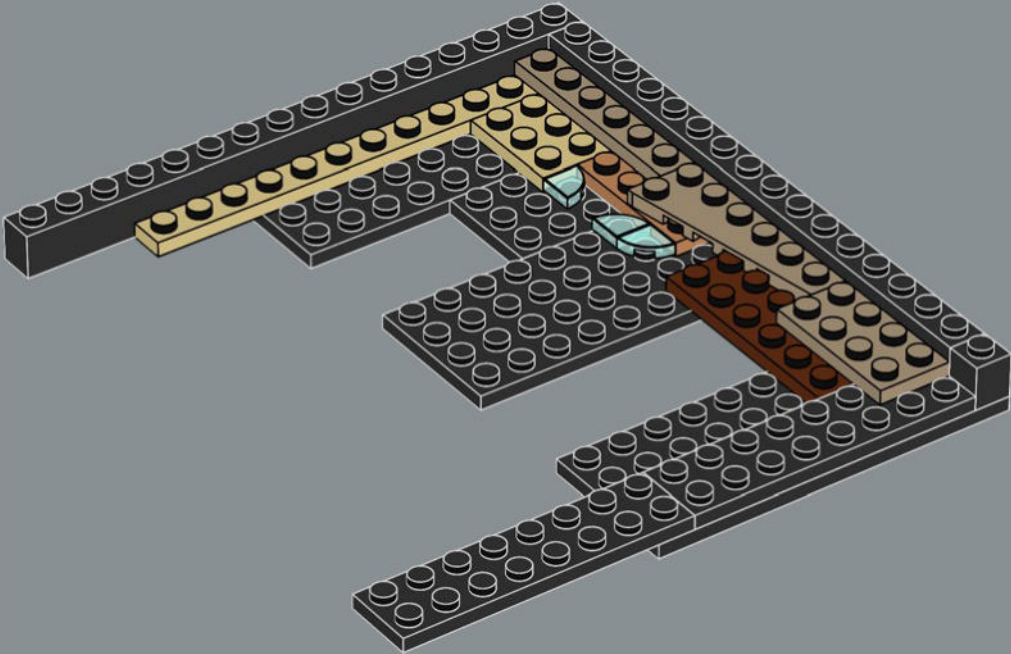

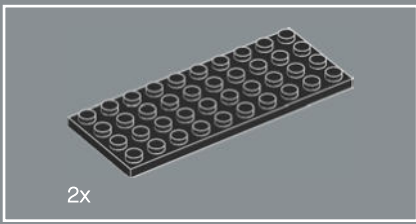

9

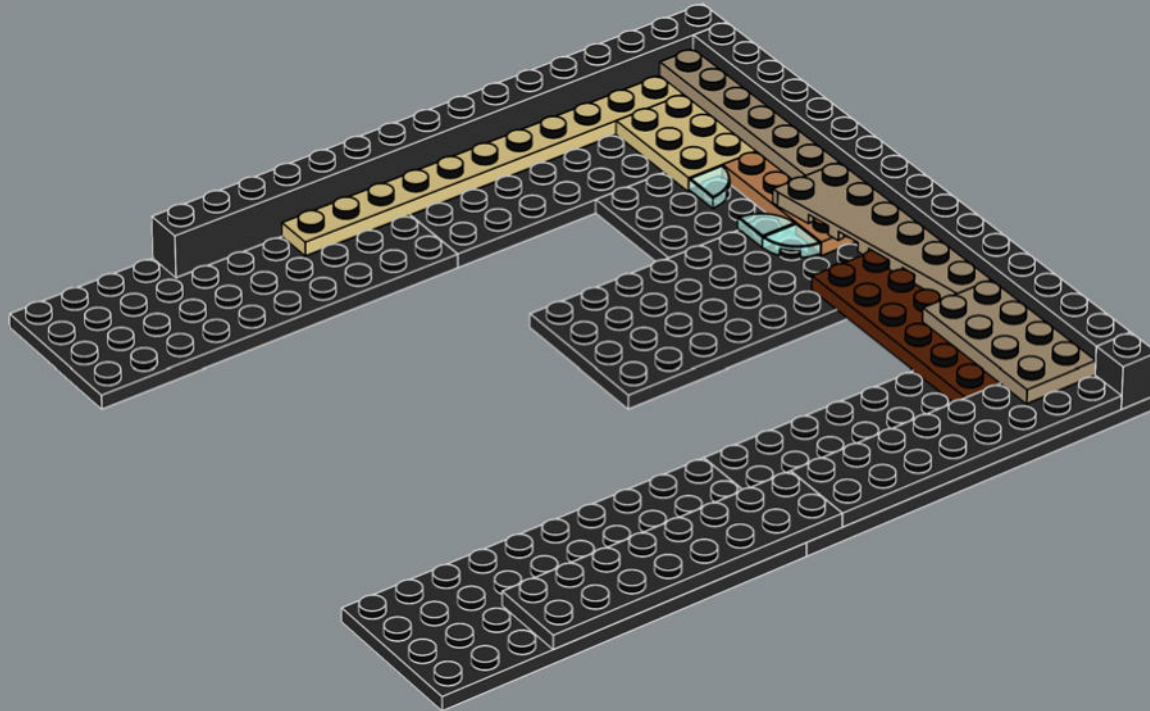

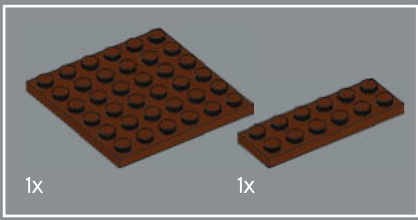

10

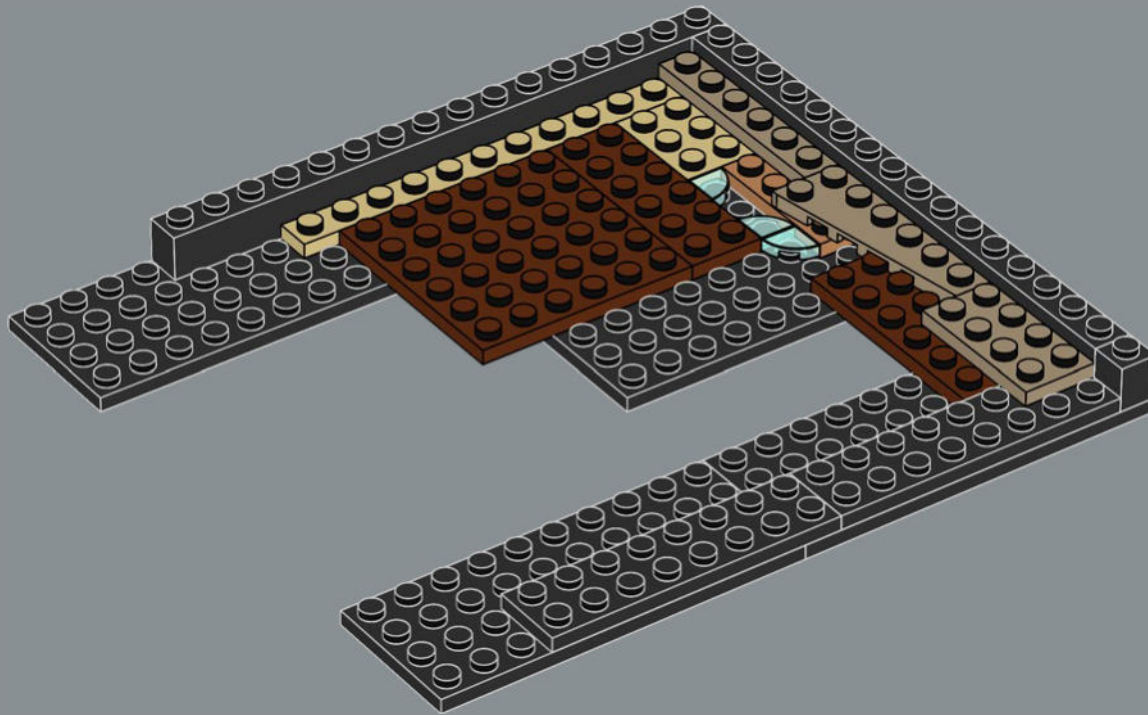

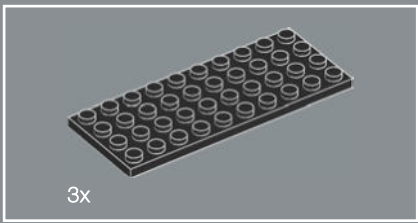

12

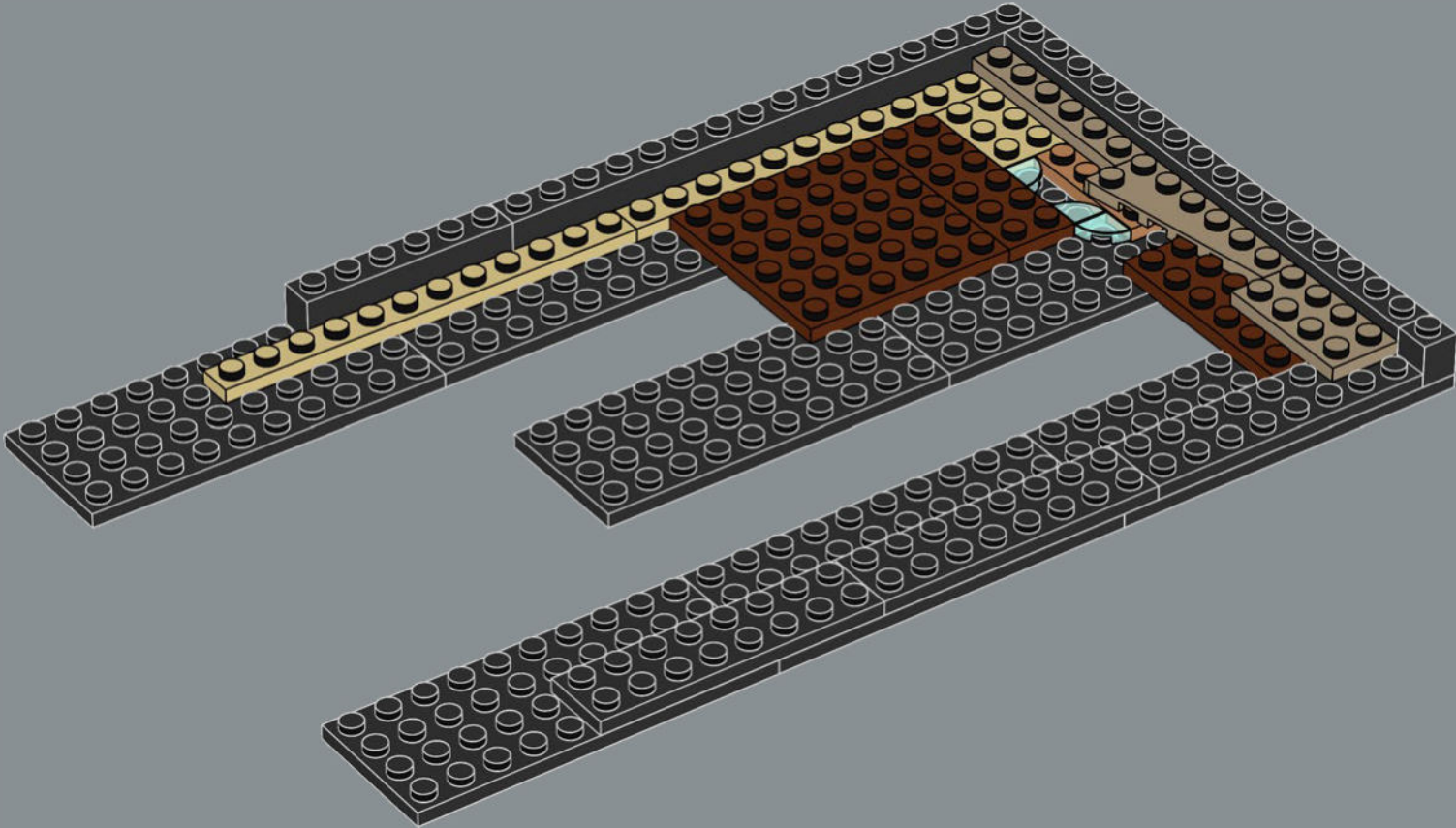

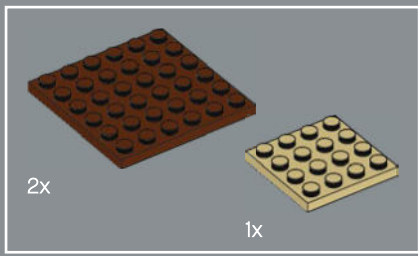

13

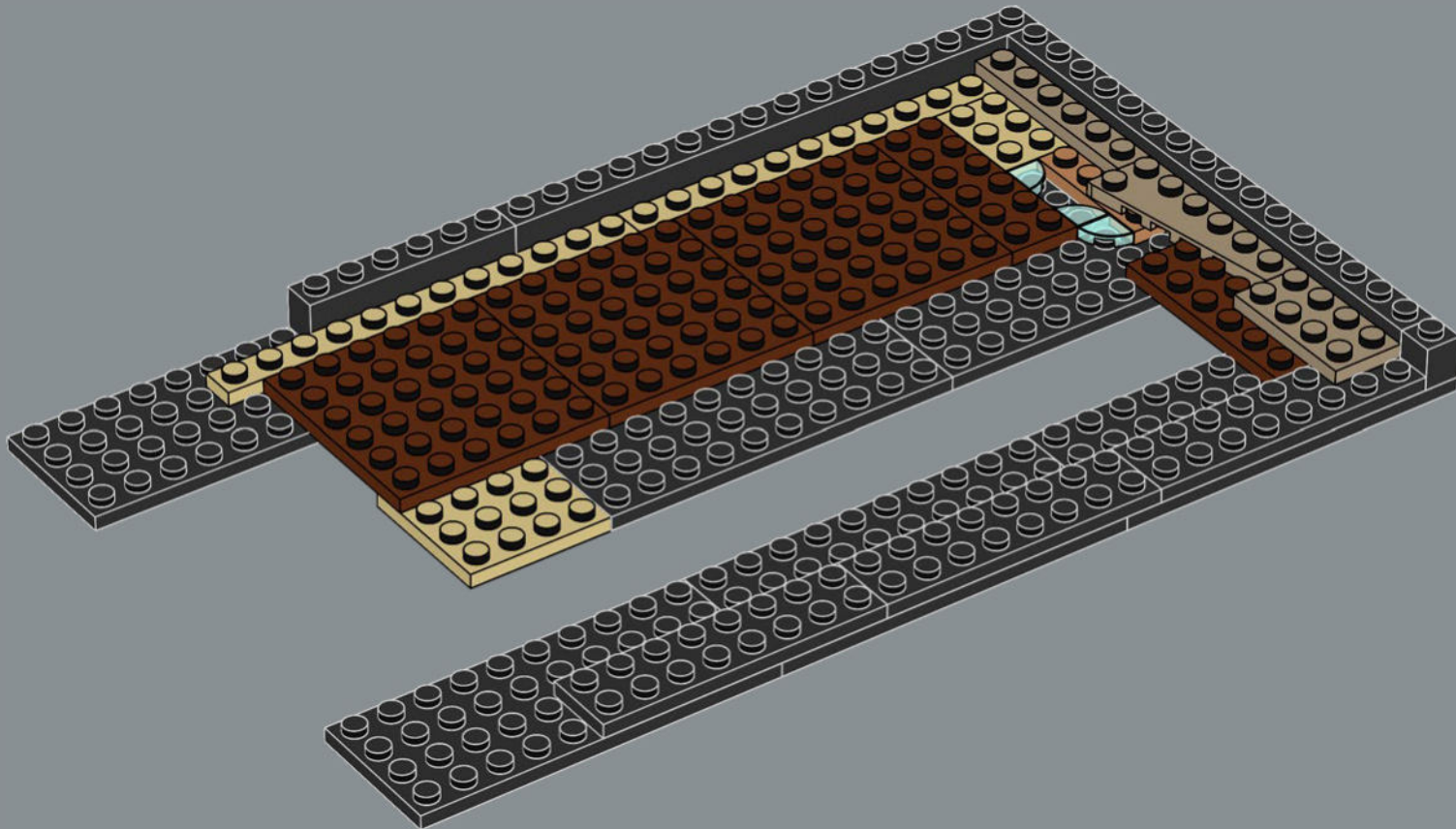

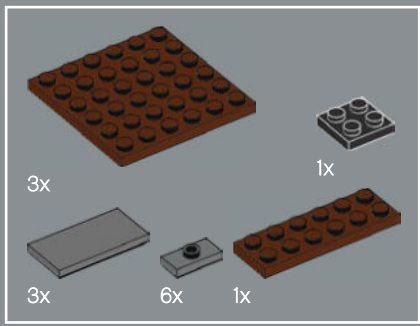

14

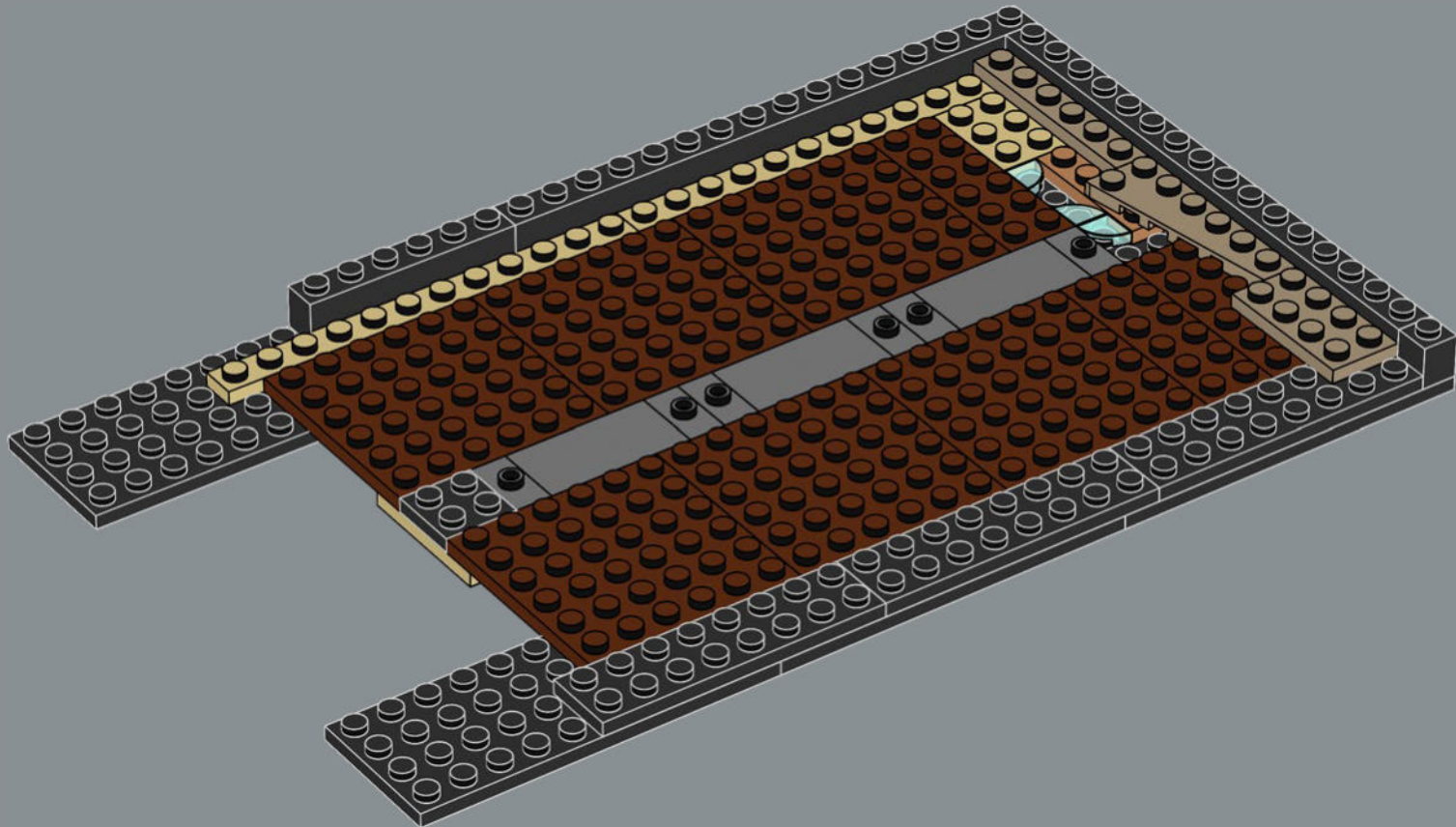

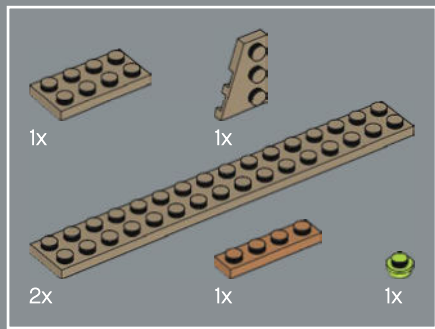

15

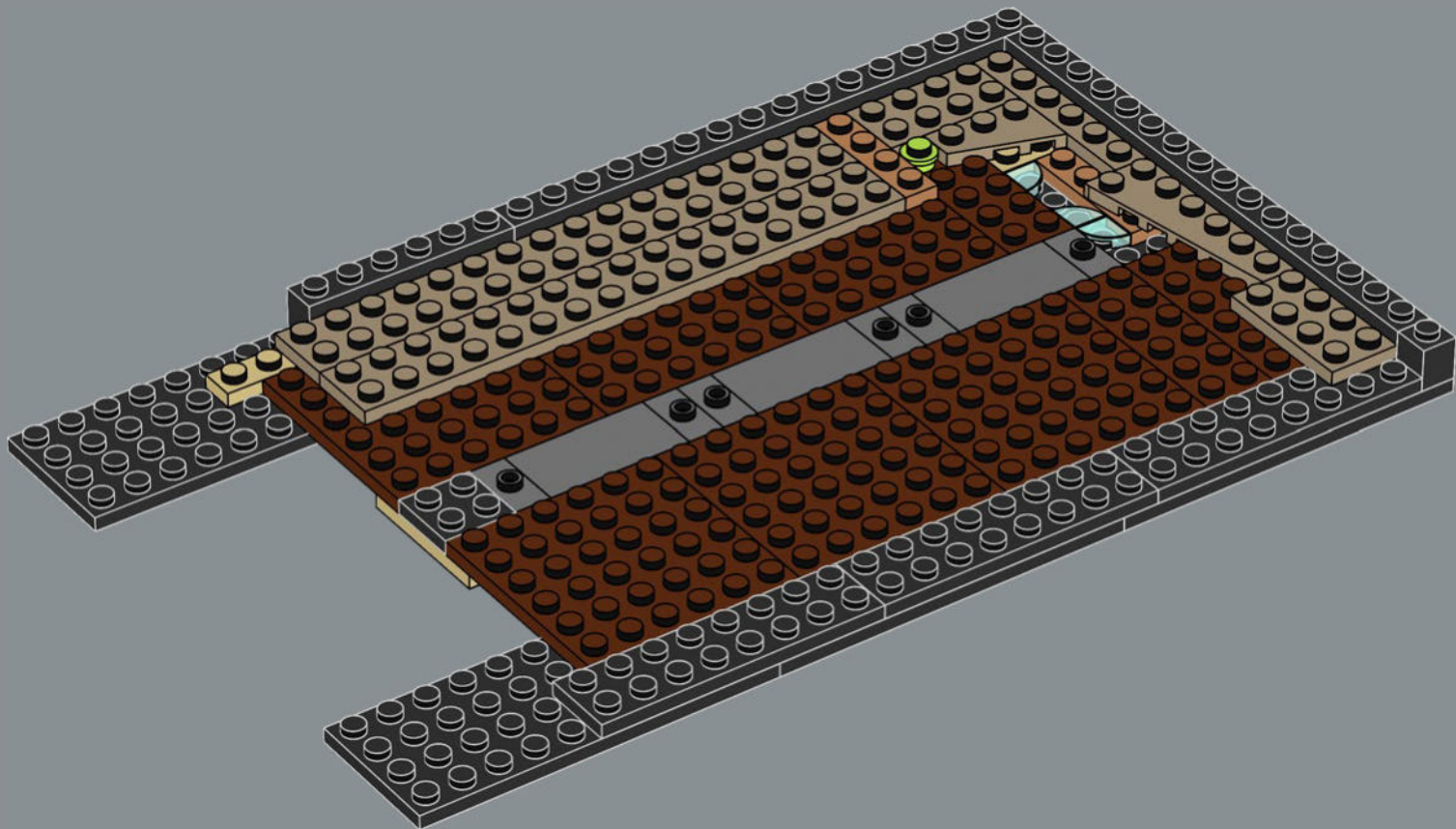

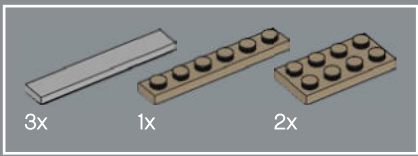

16

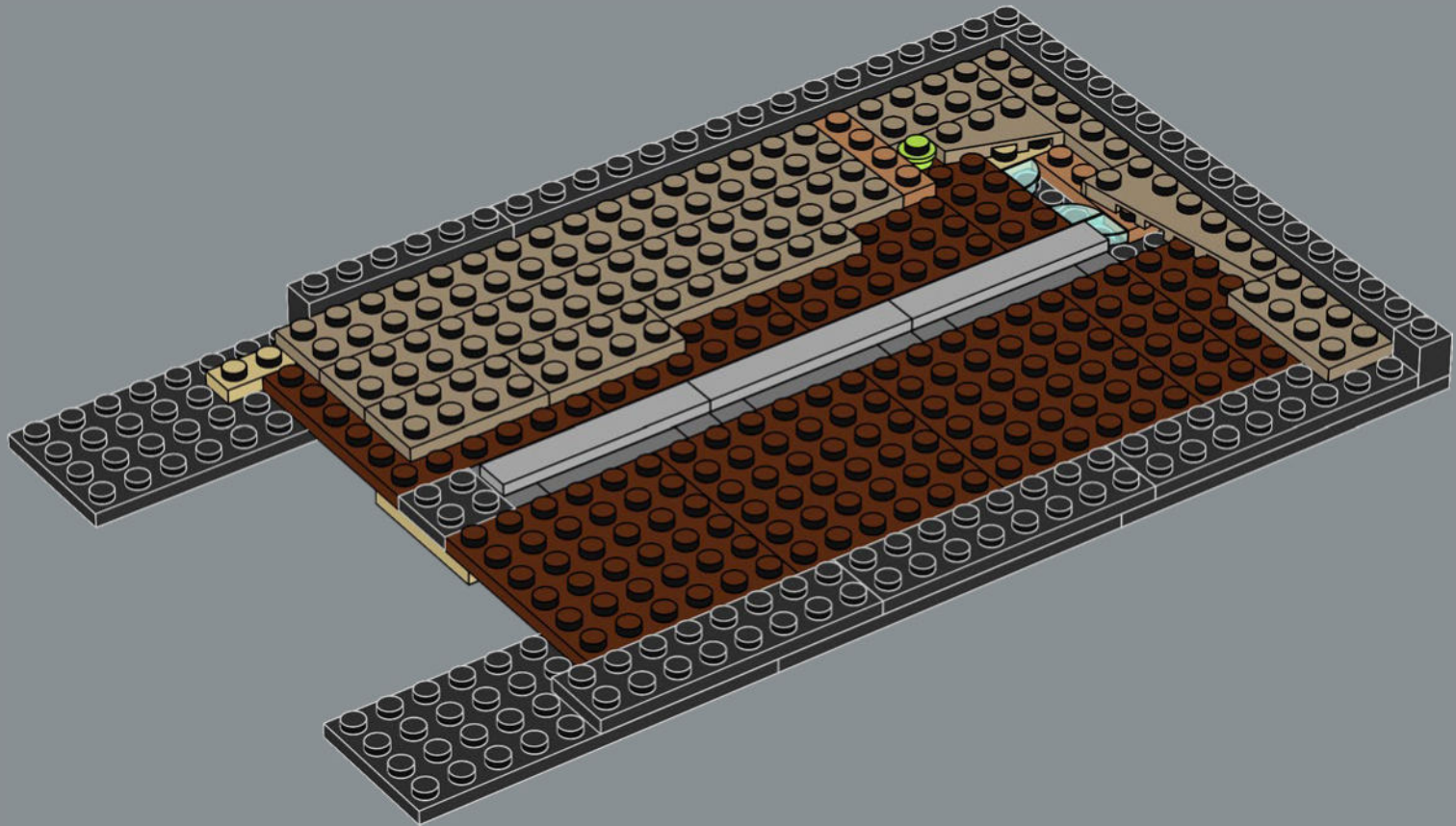

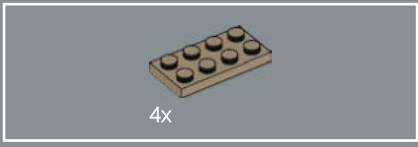

17

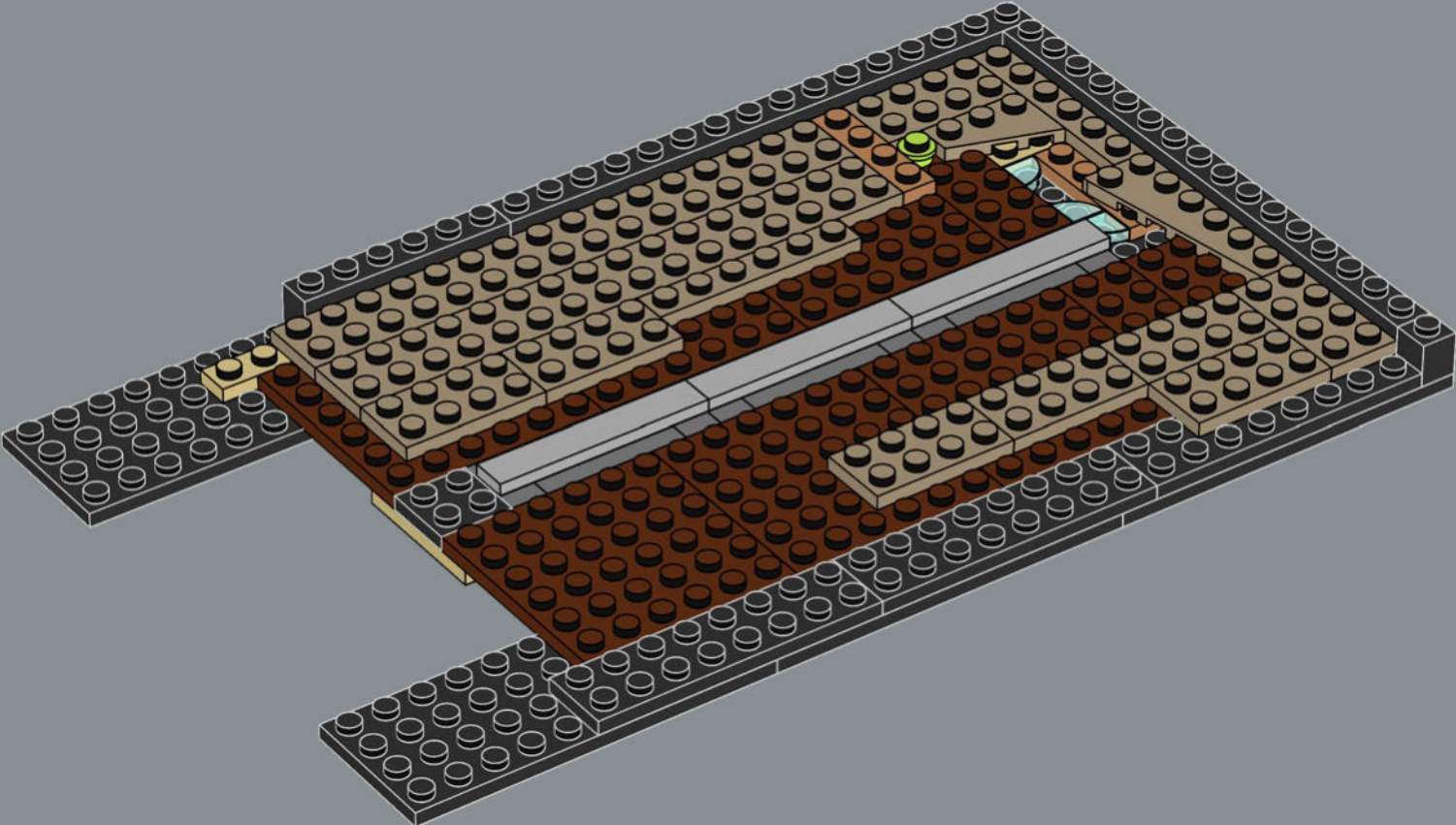

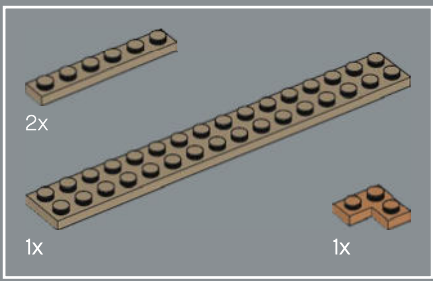

18

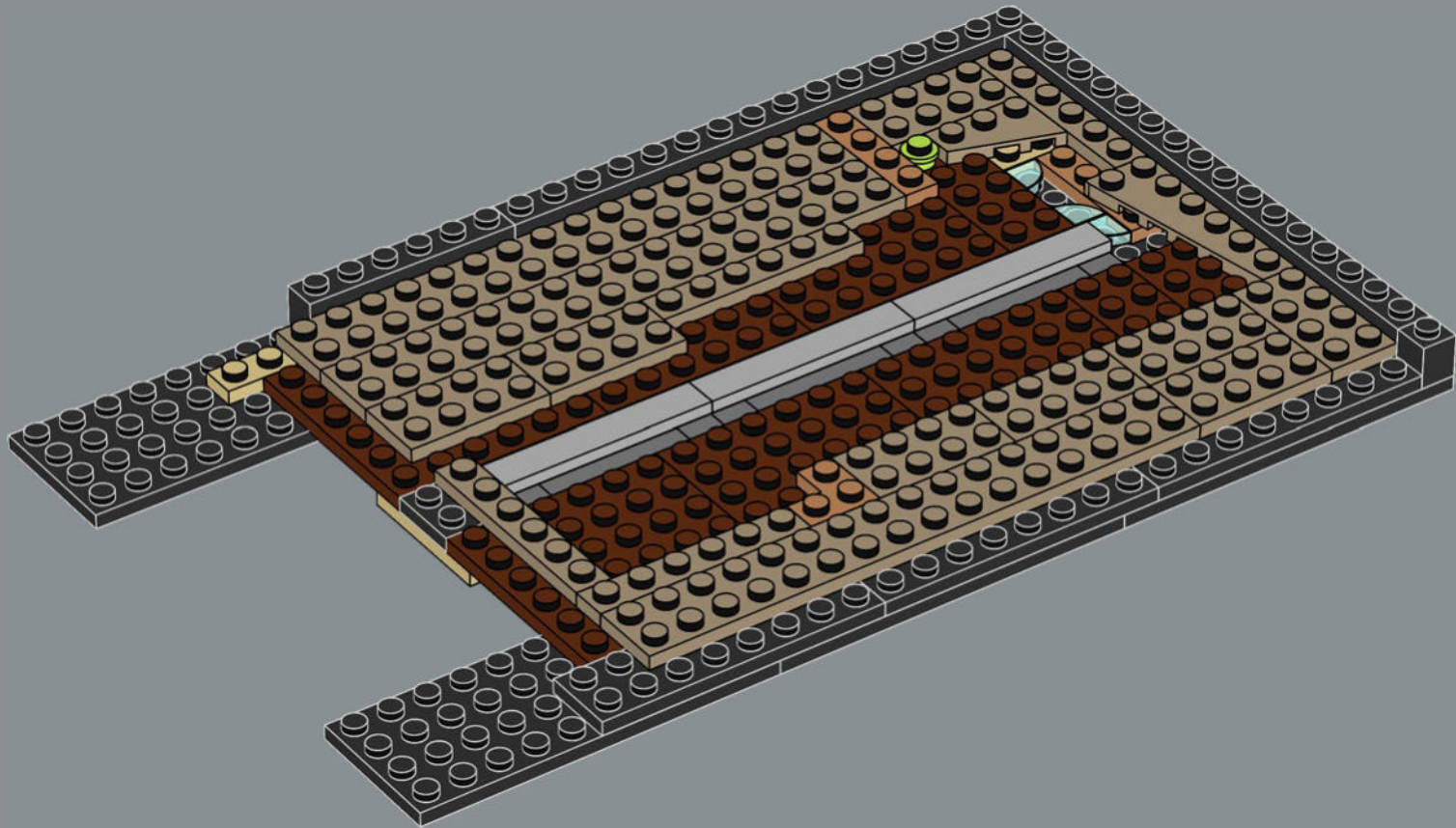

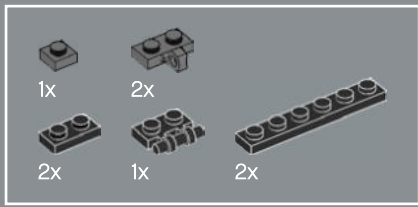

19

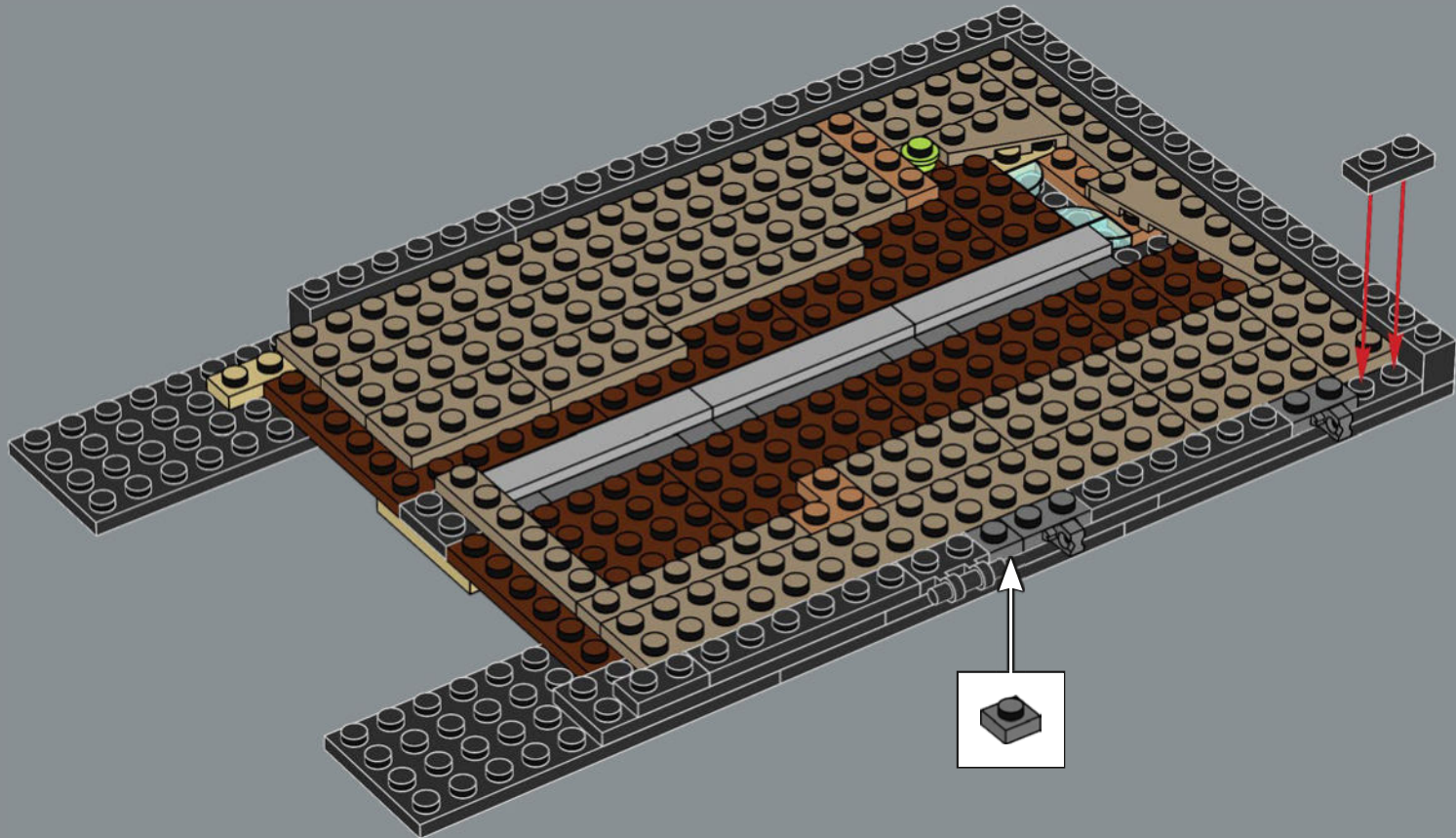

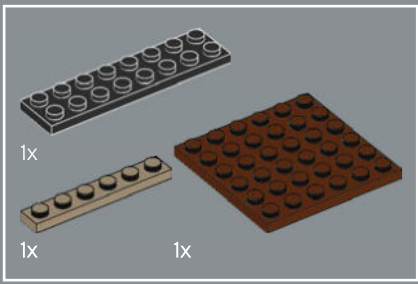

20

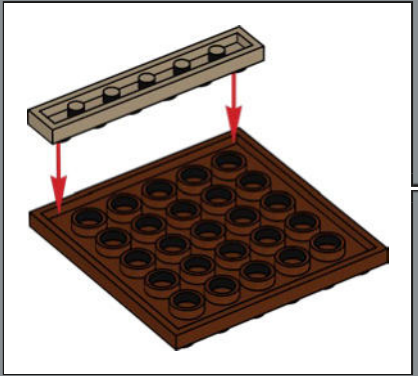
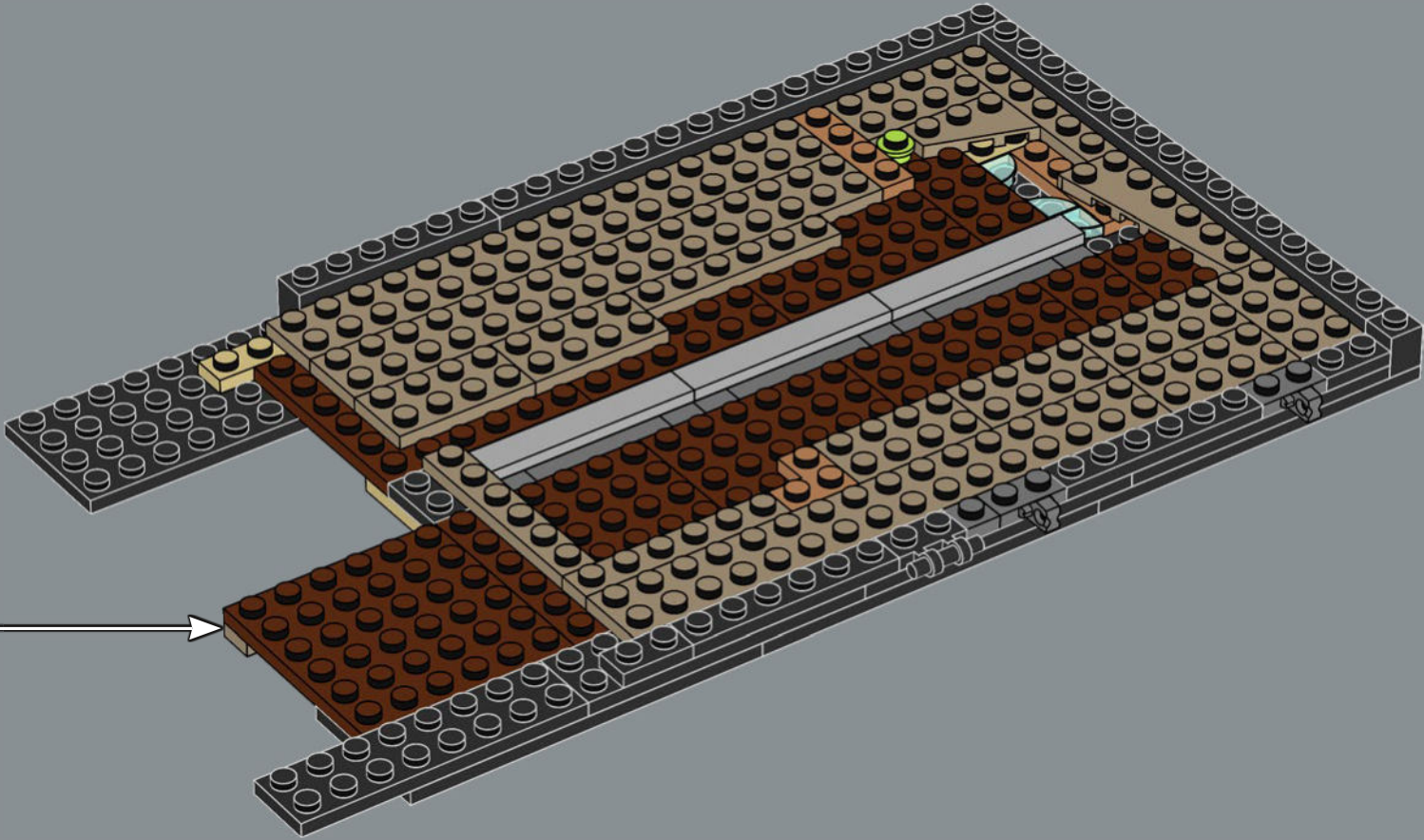

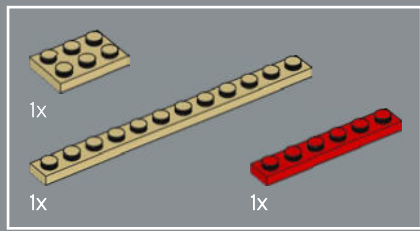

21

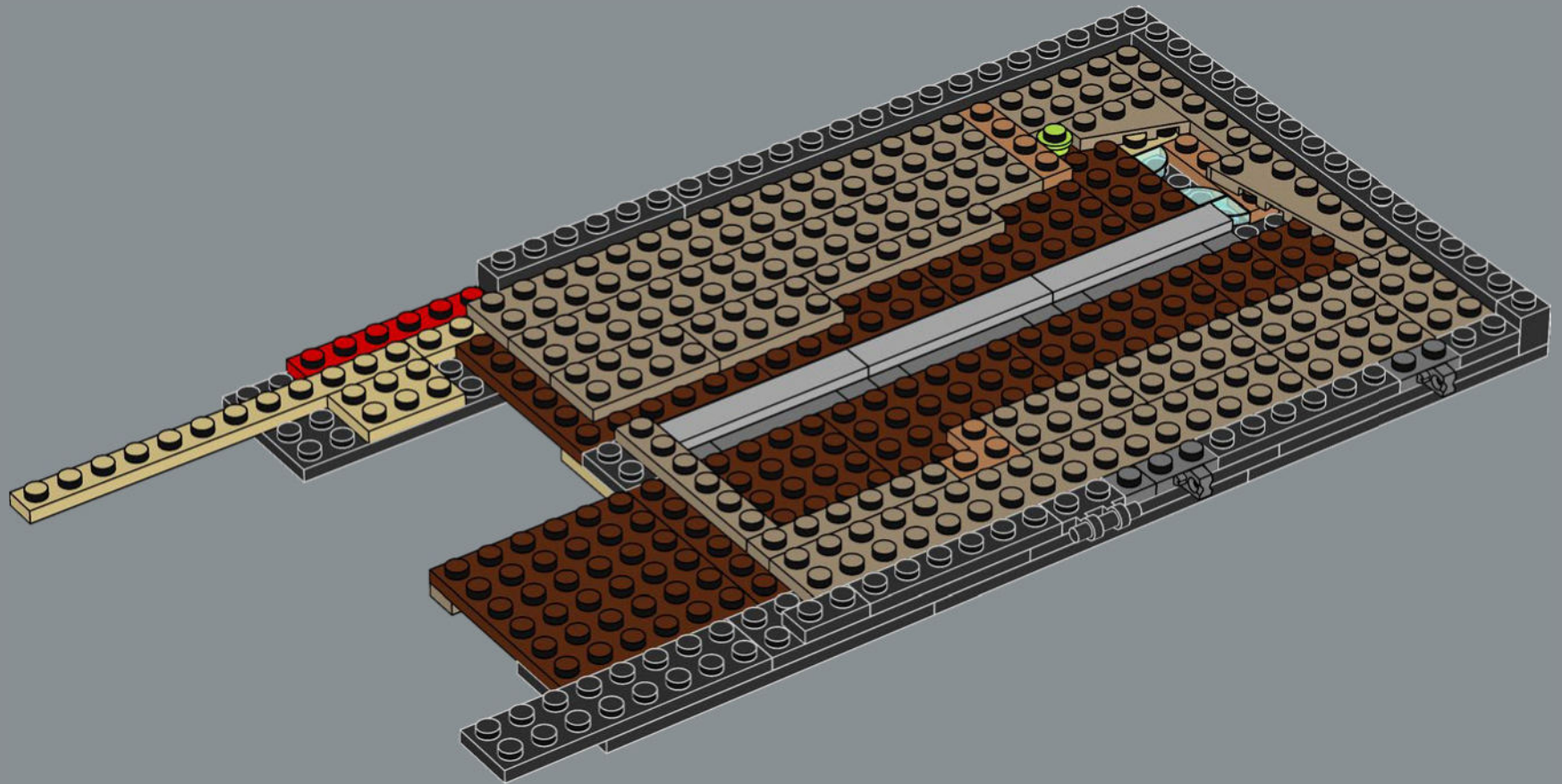

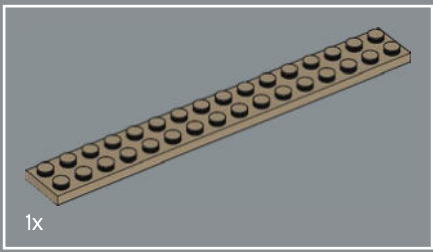

22

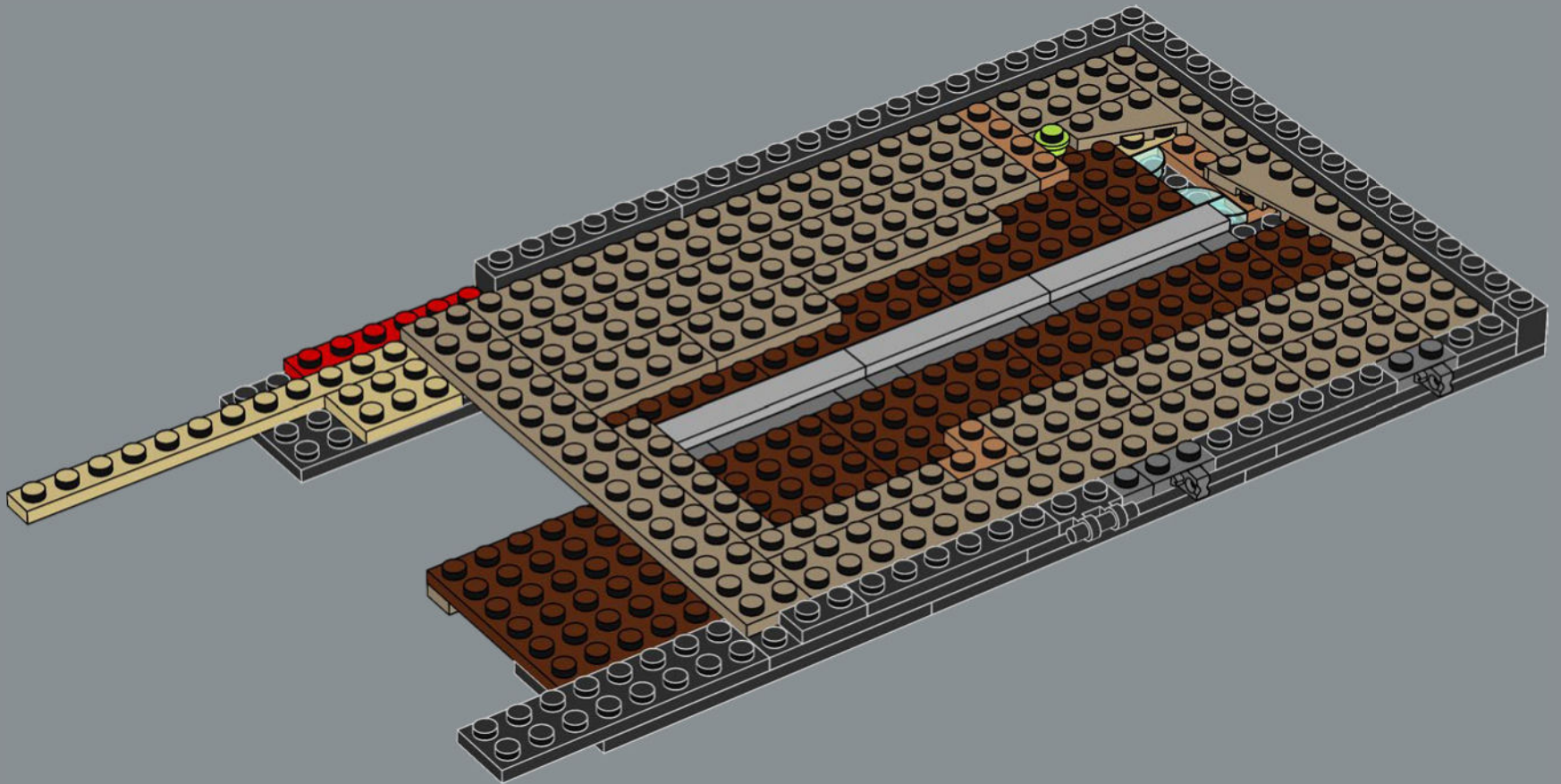

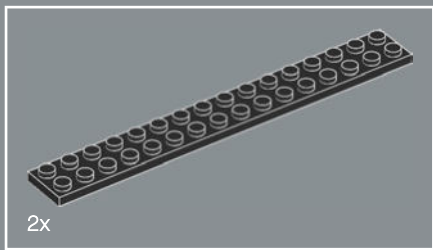

23

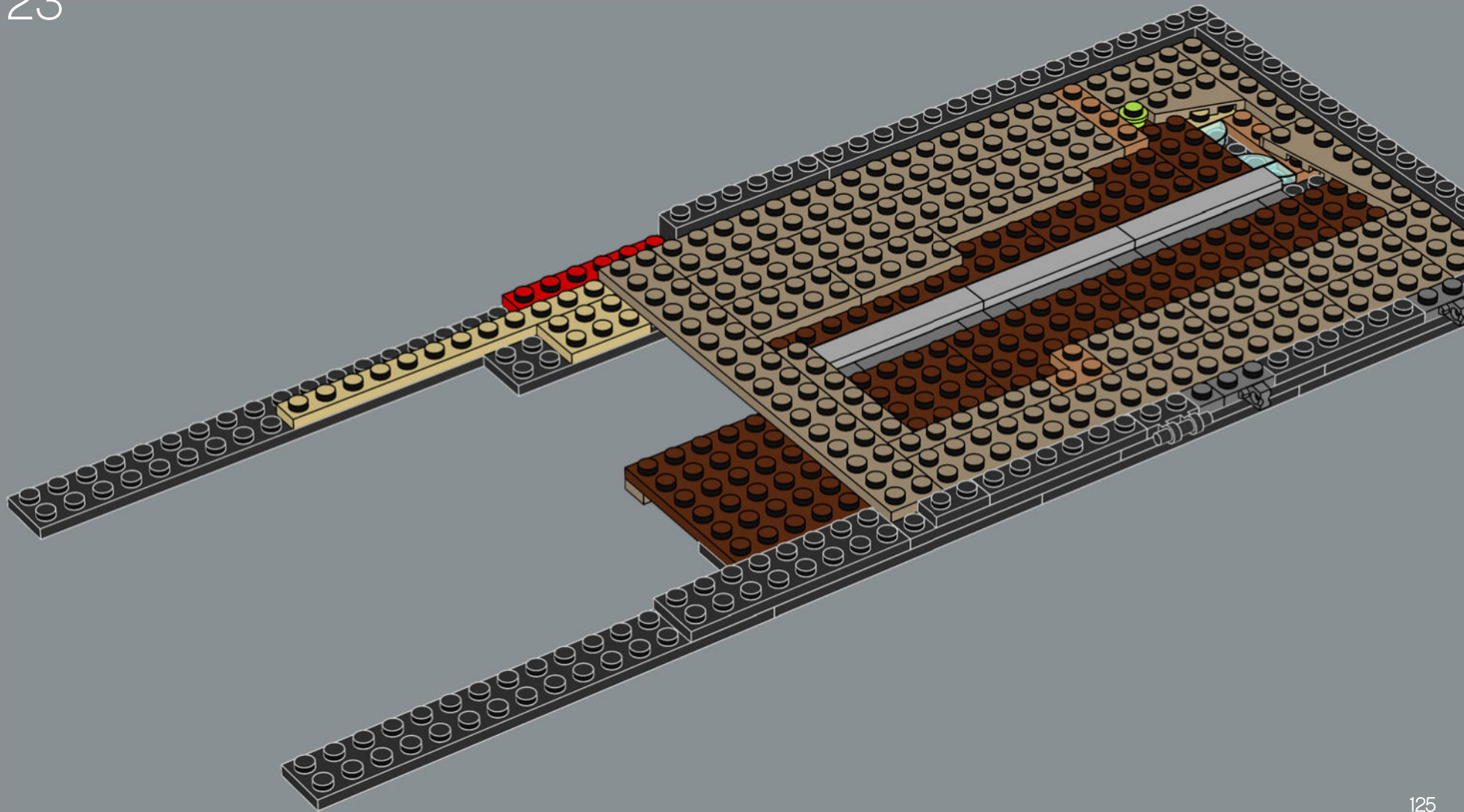

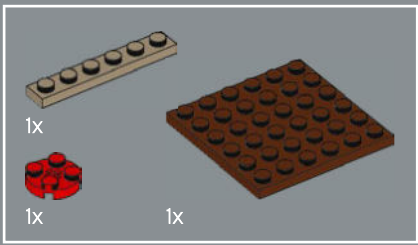

24

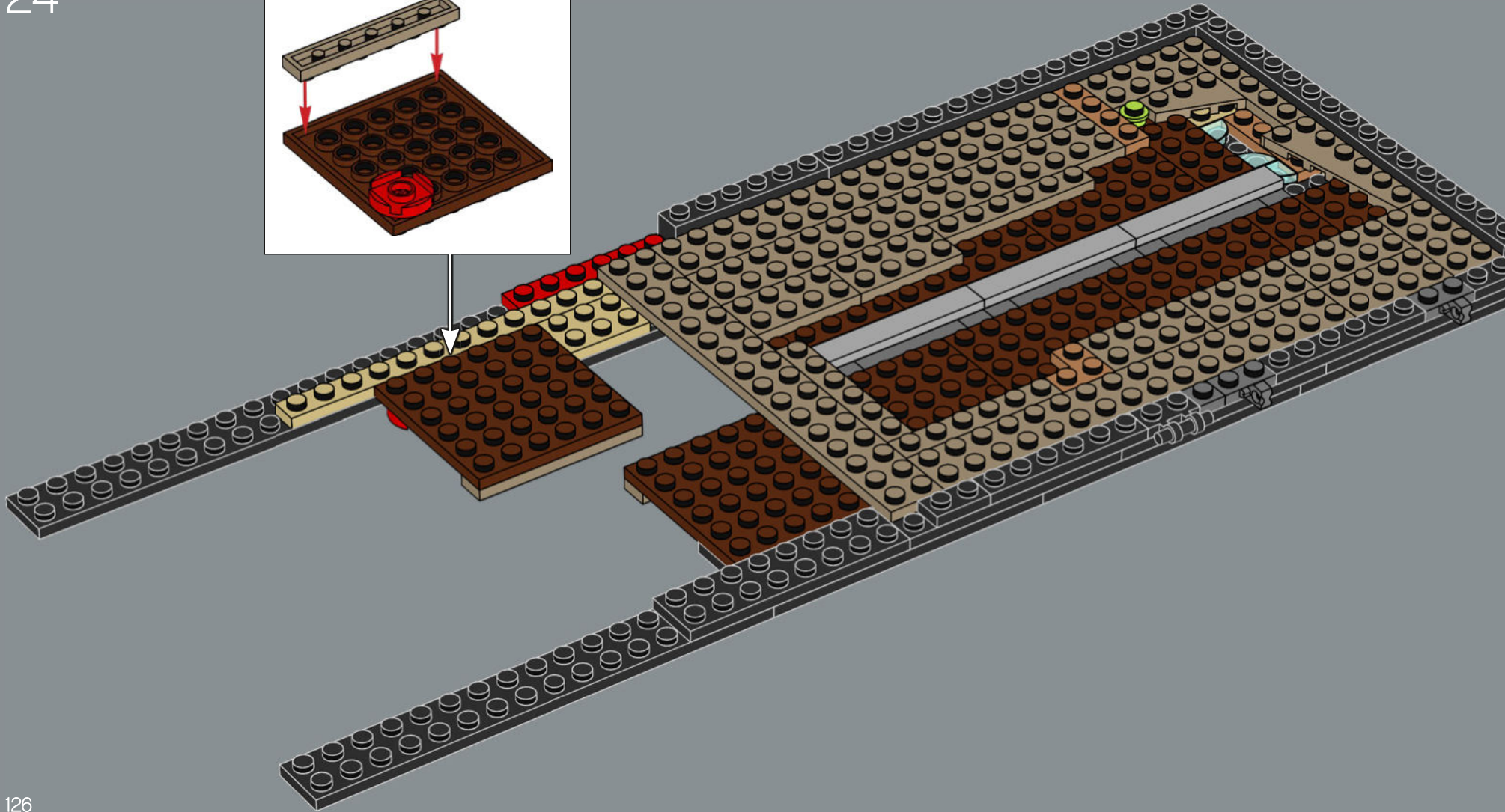
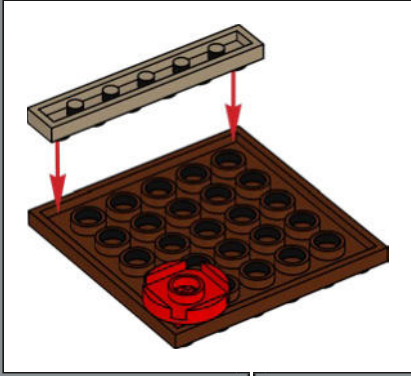

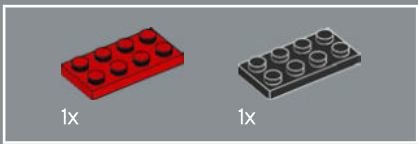

26

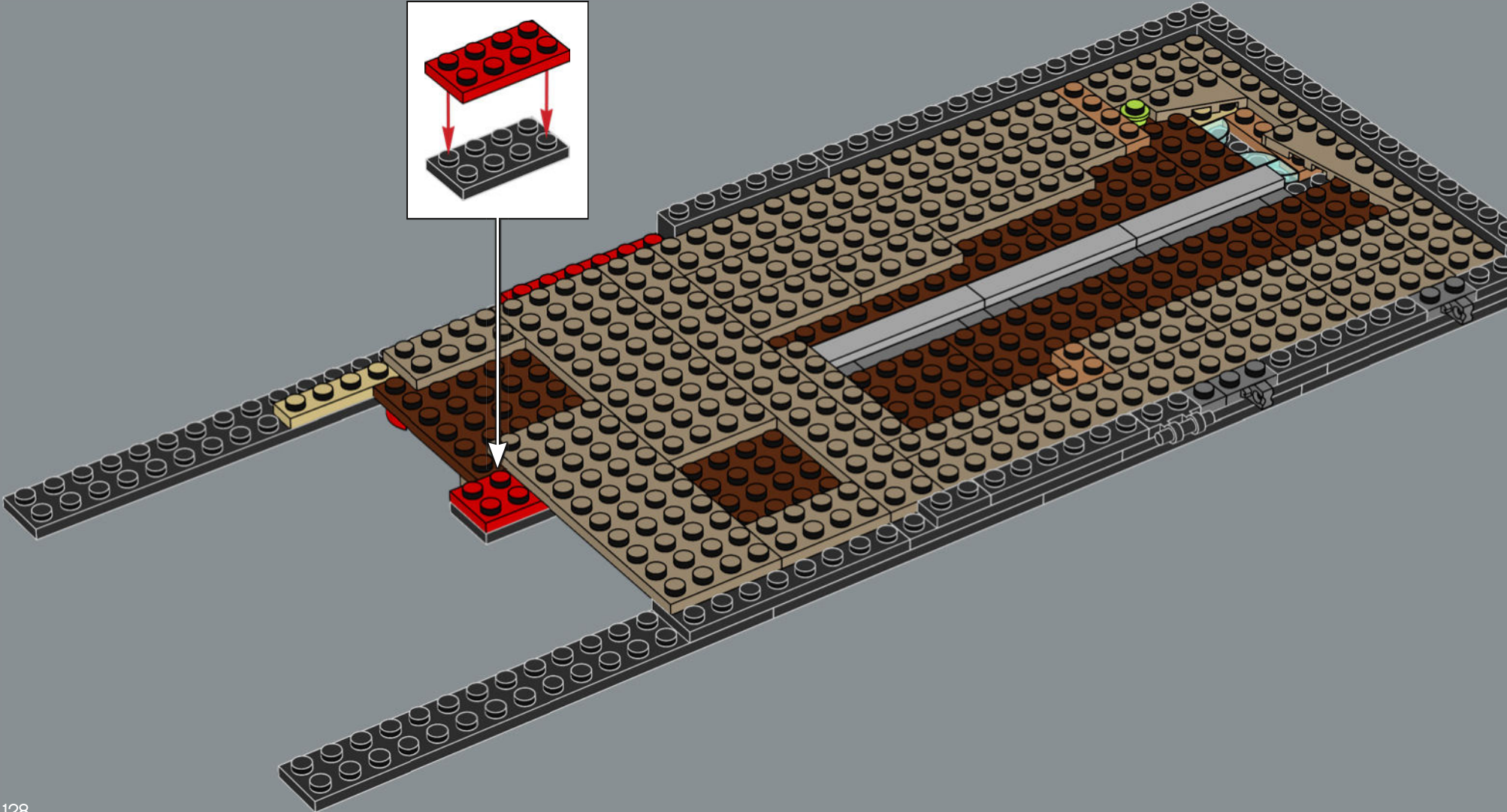
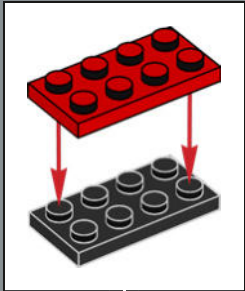

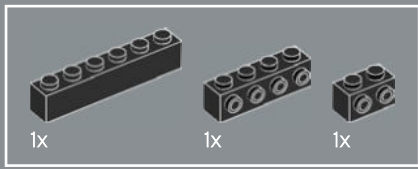

27

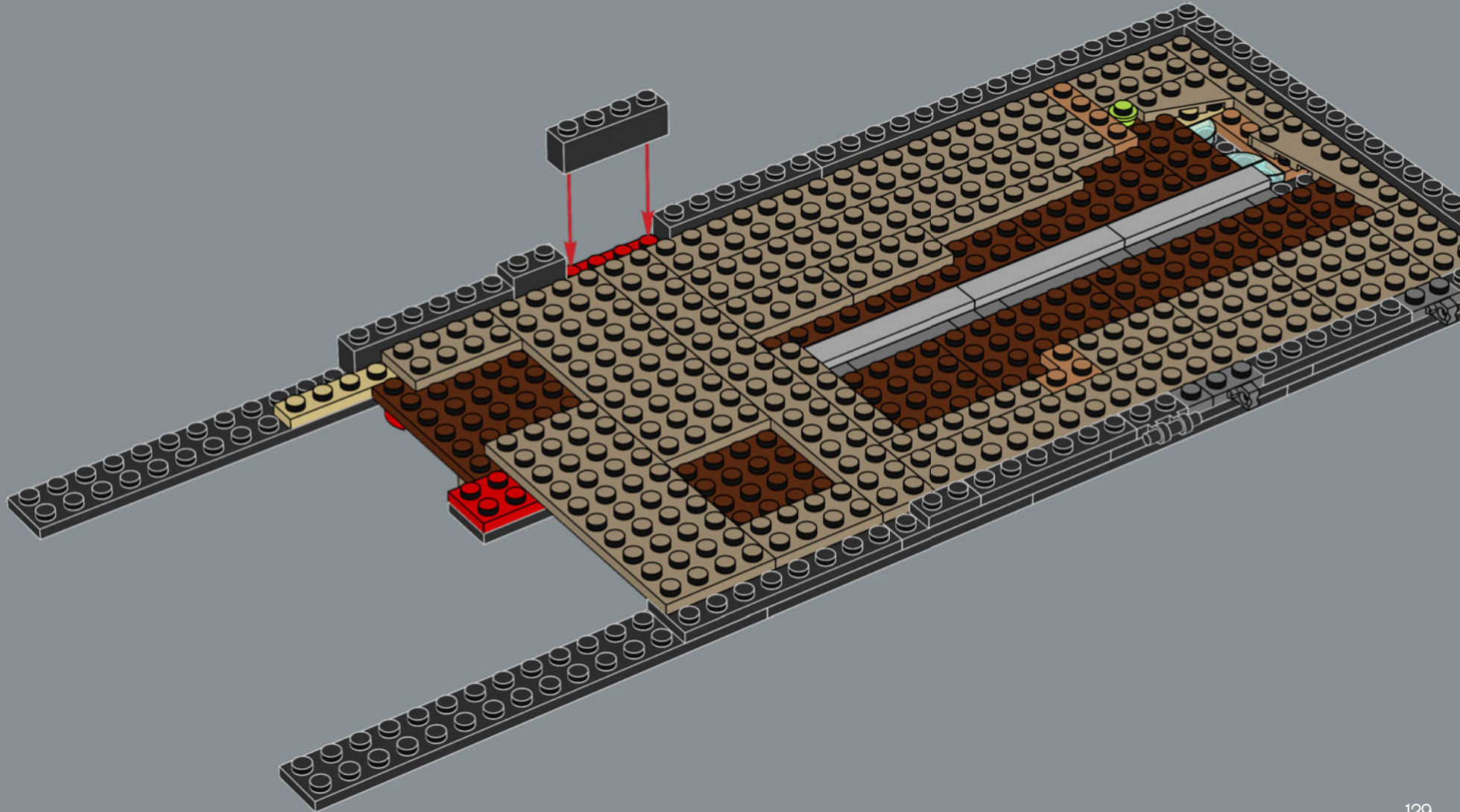

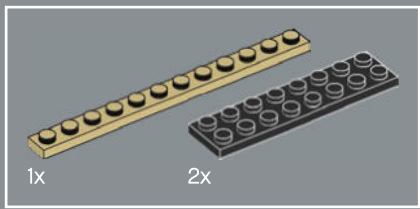

28

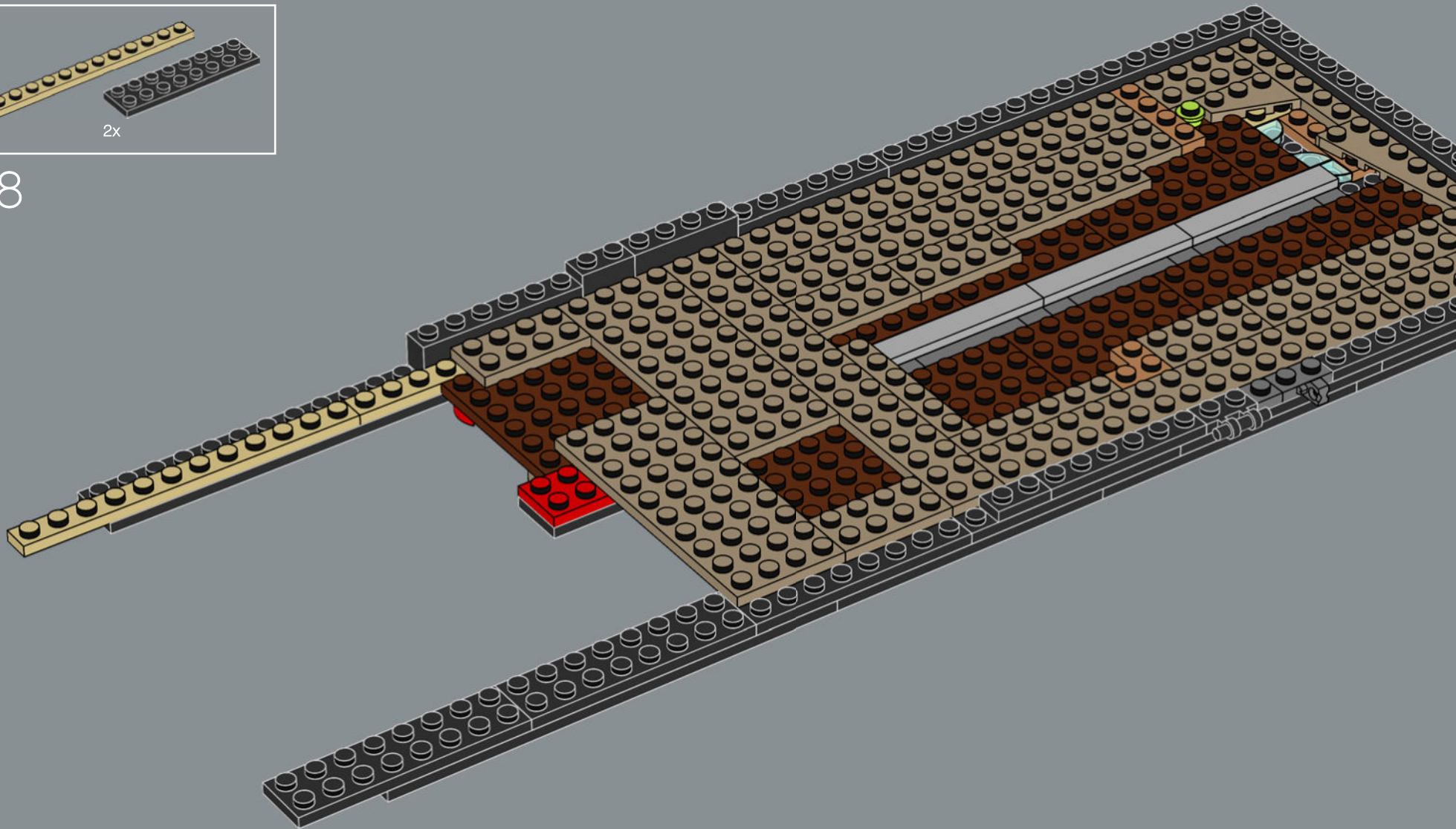

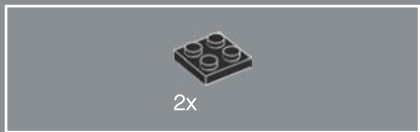

29

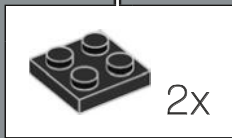
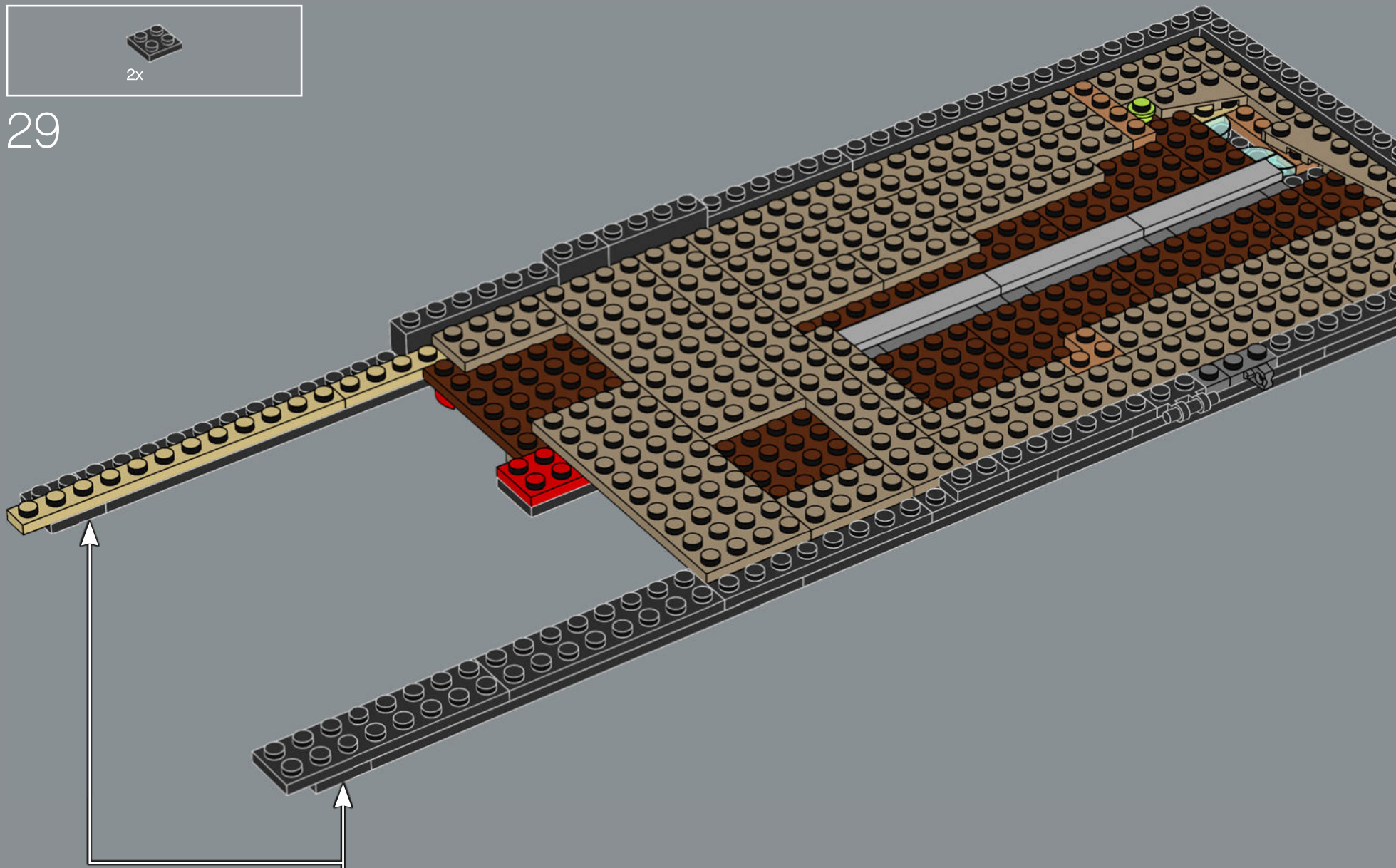

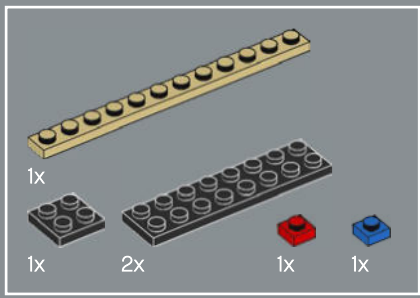

30

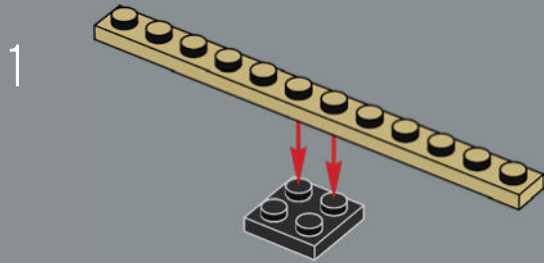

2

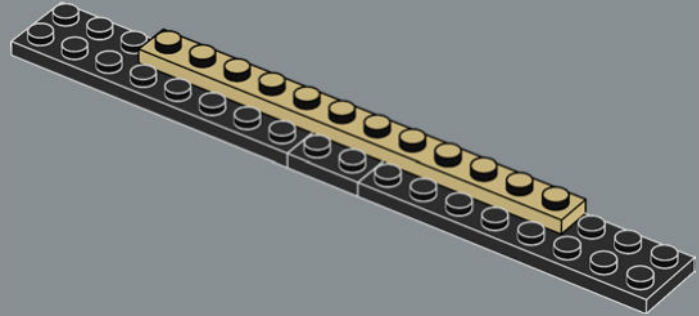

3

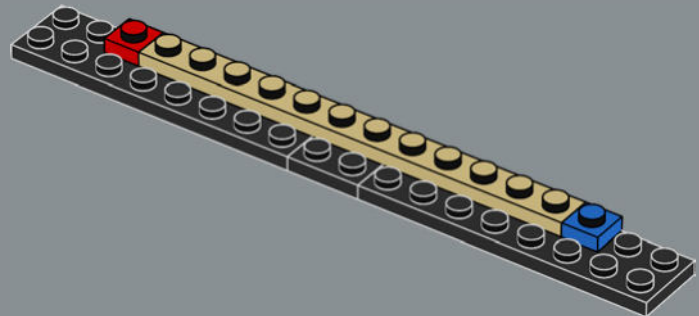

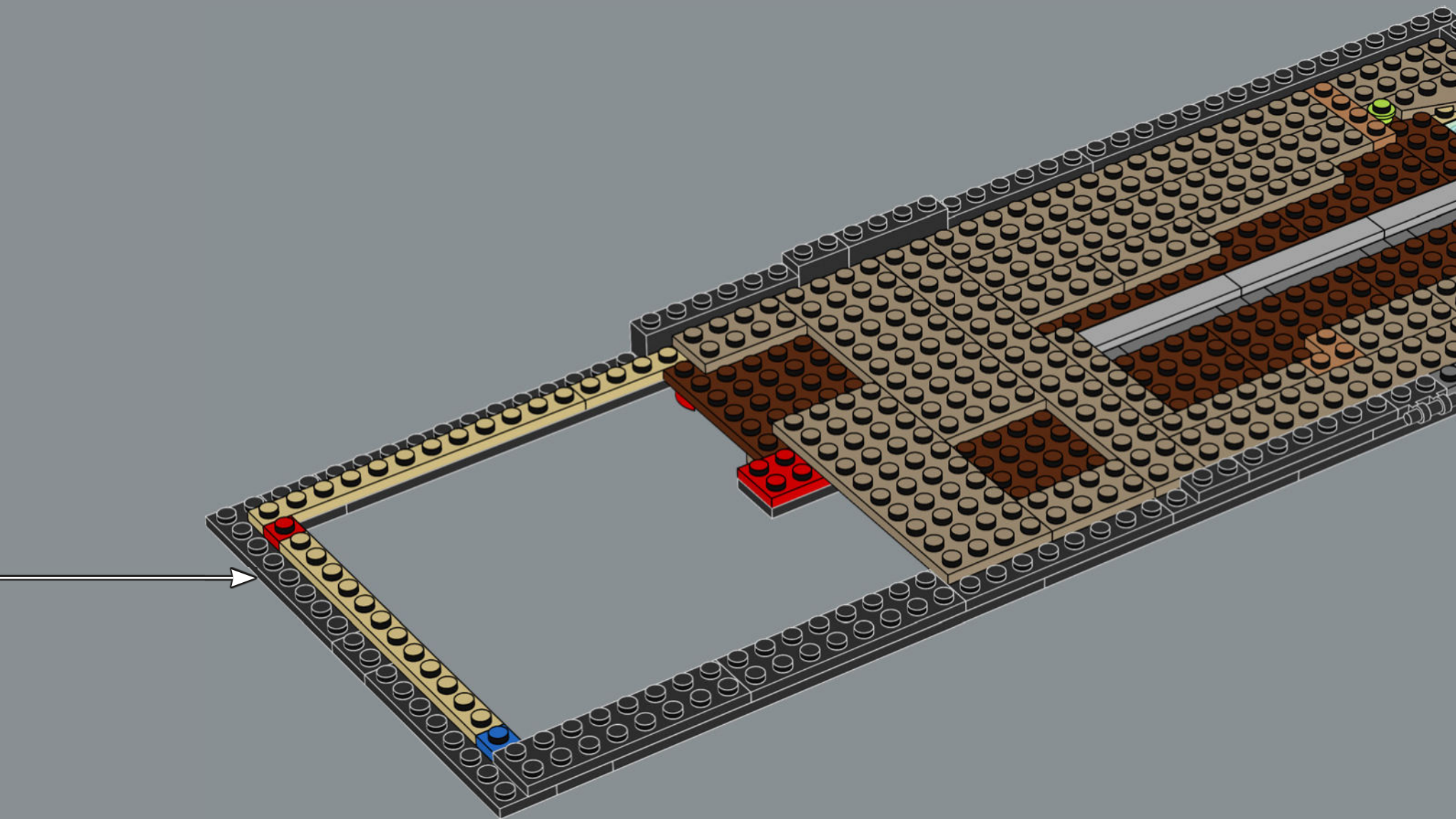

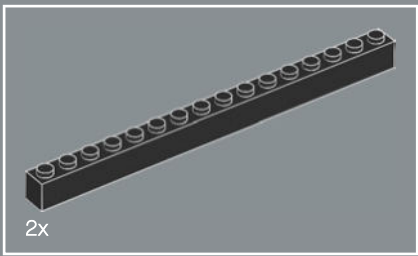

31

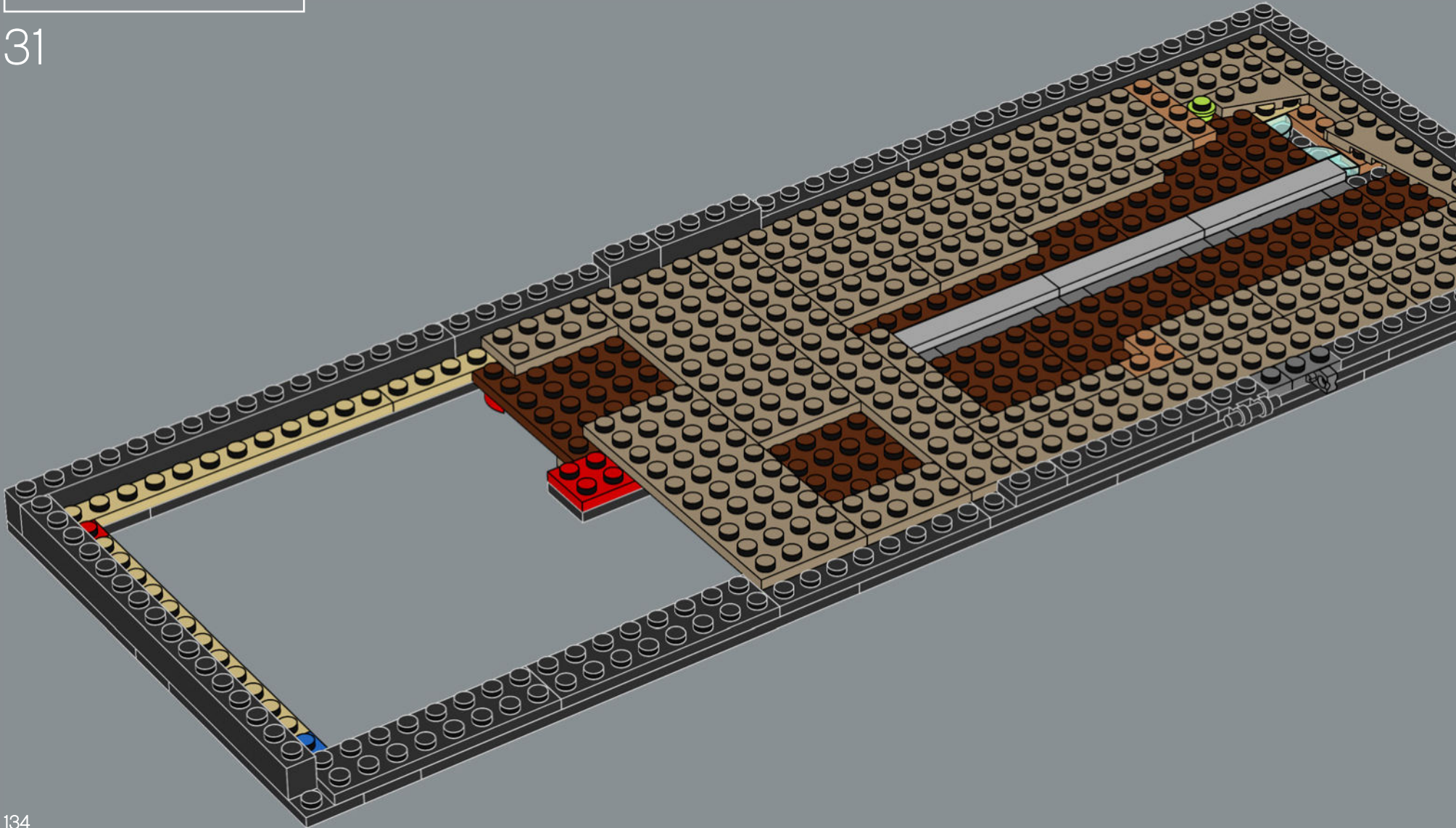

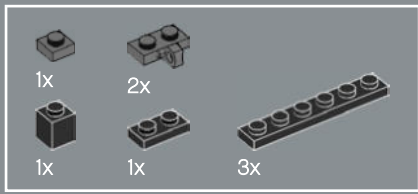

32

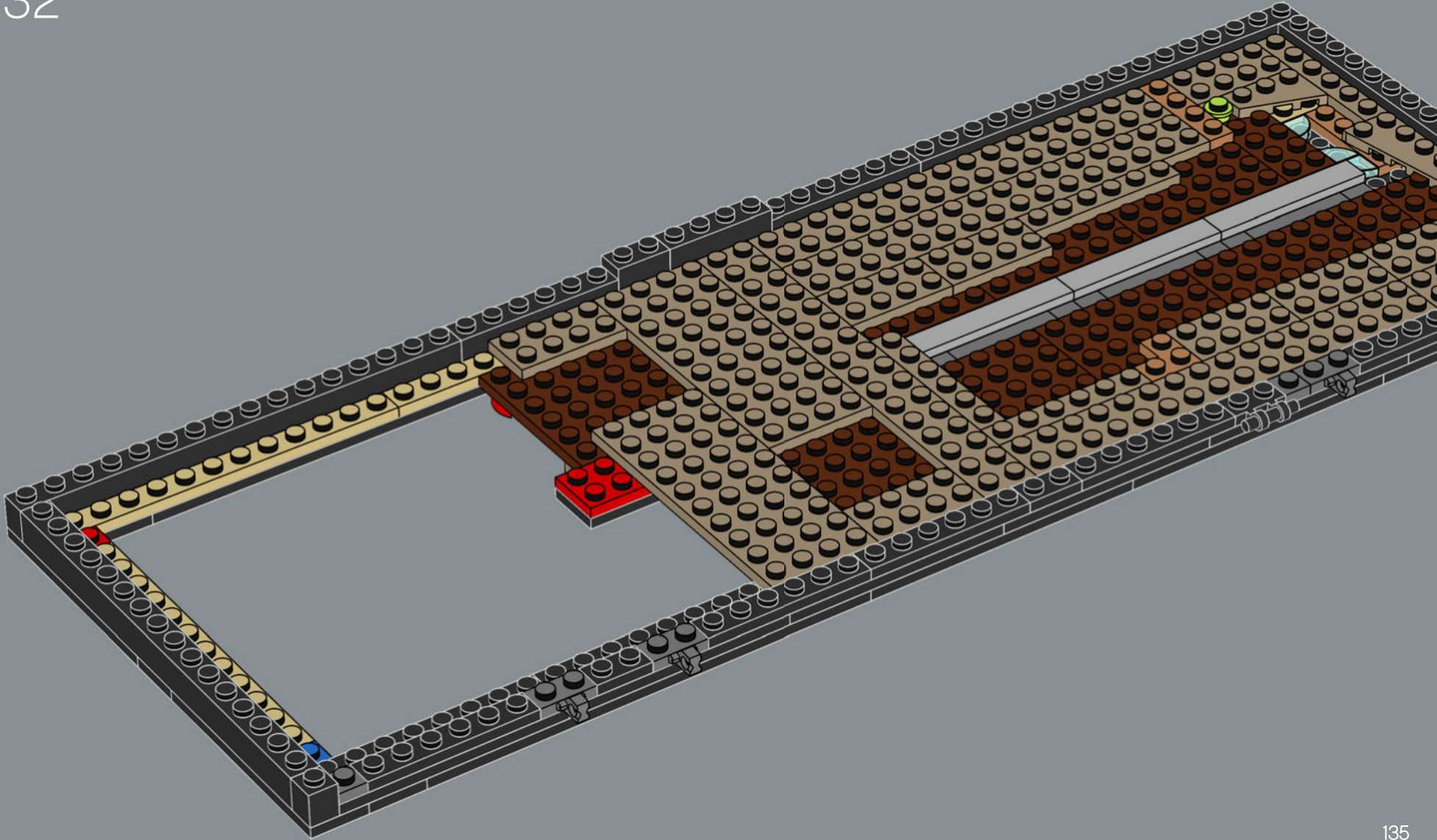

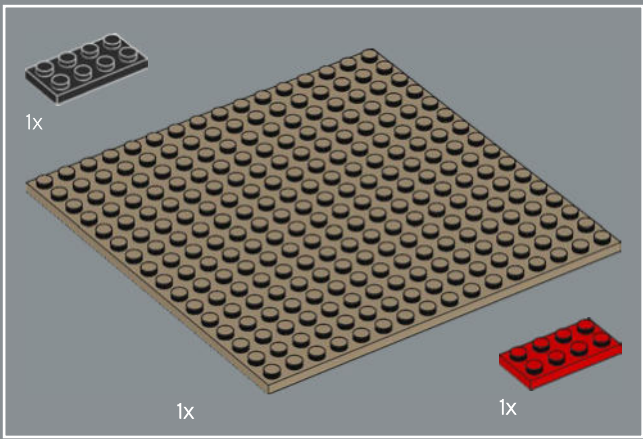

33

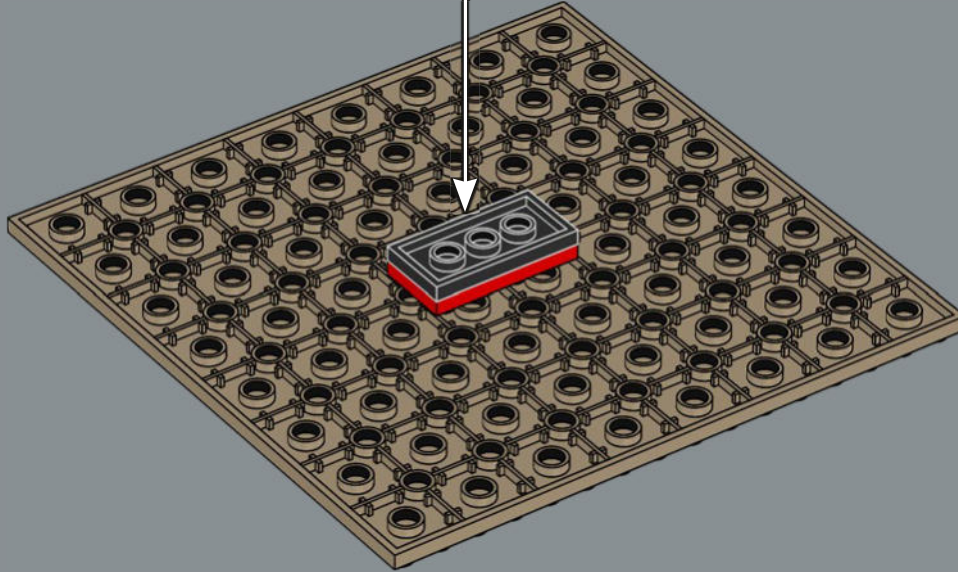
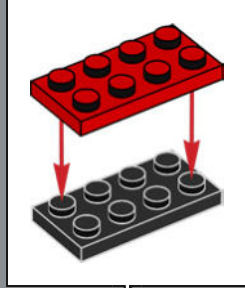

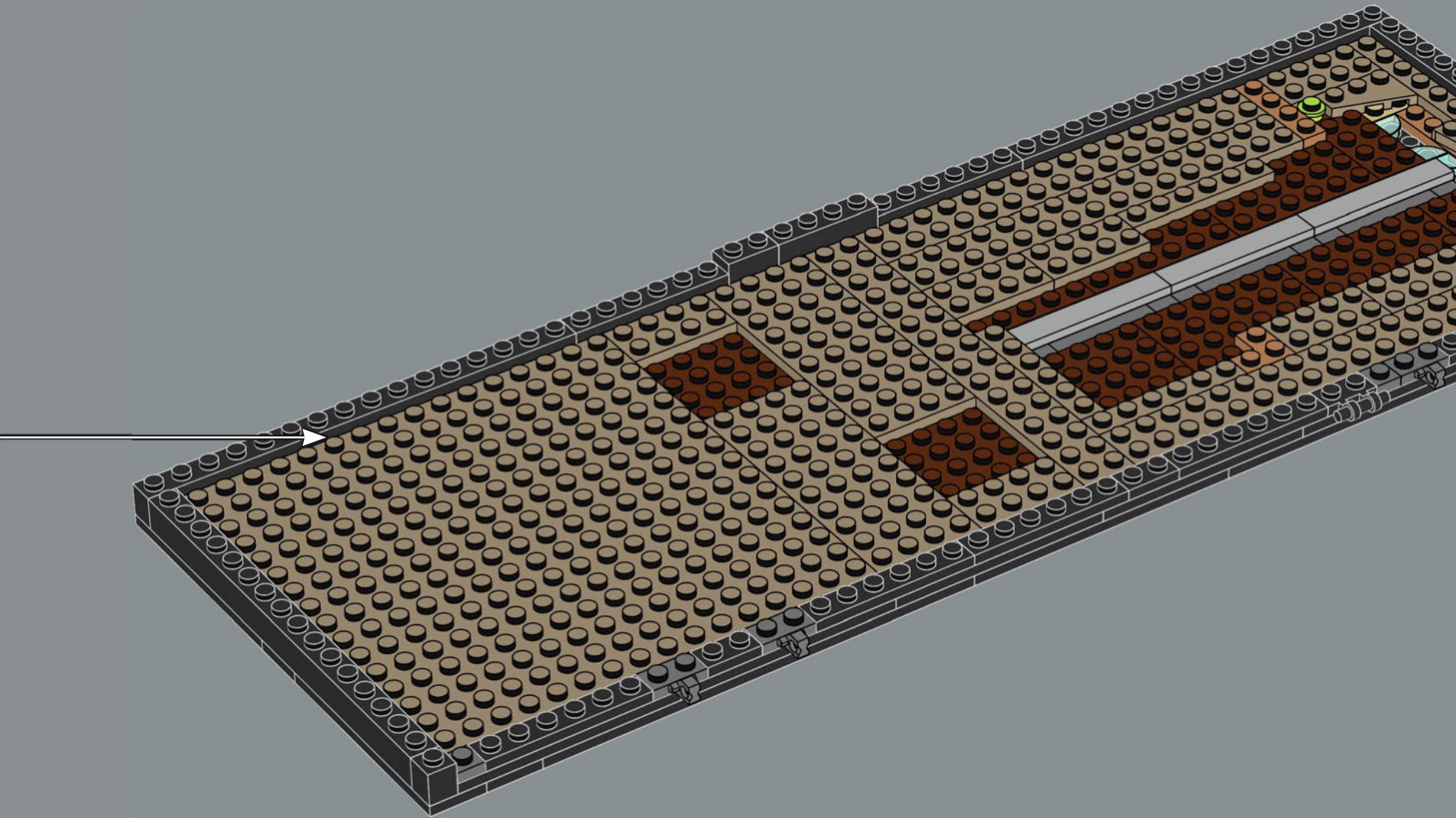

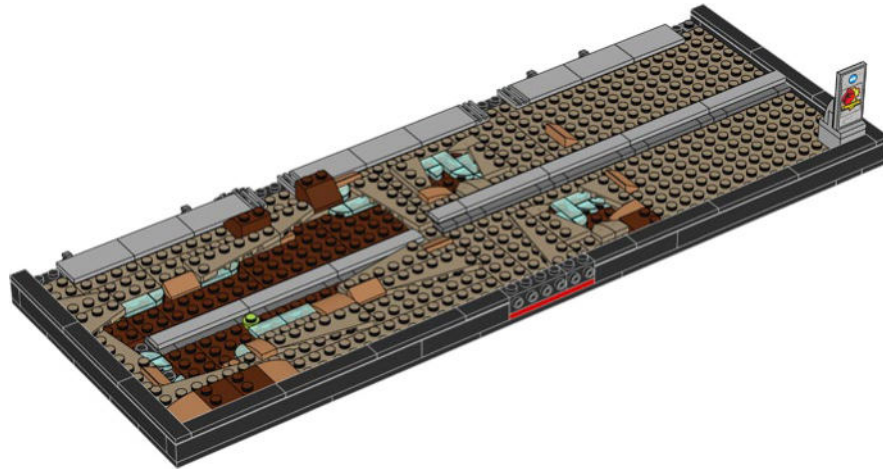
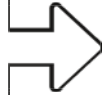

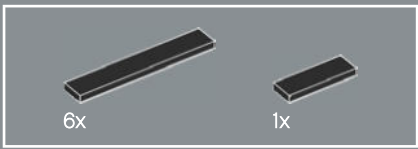

34

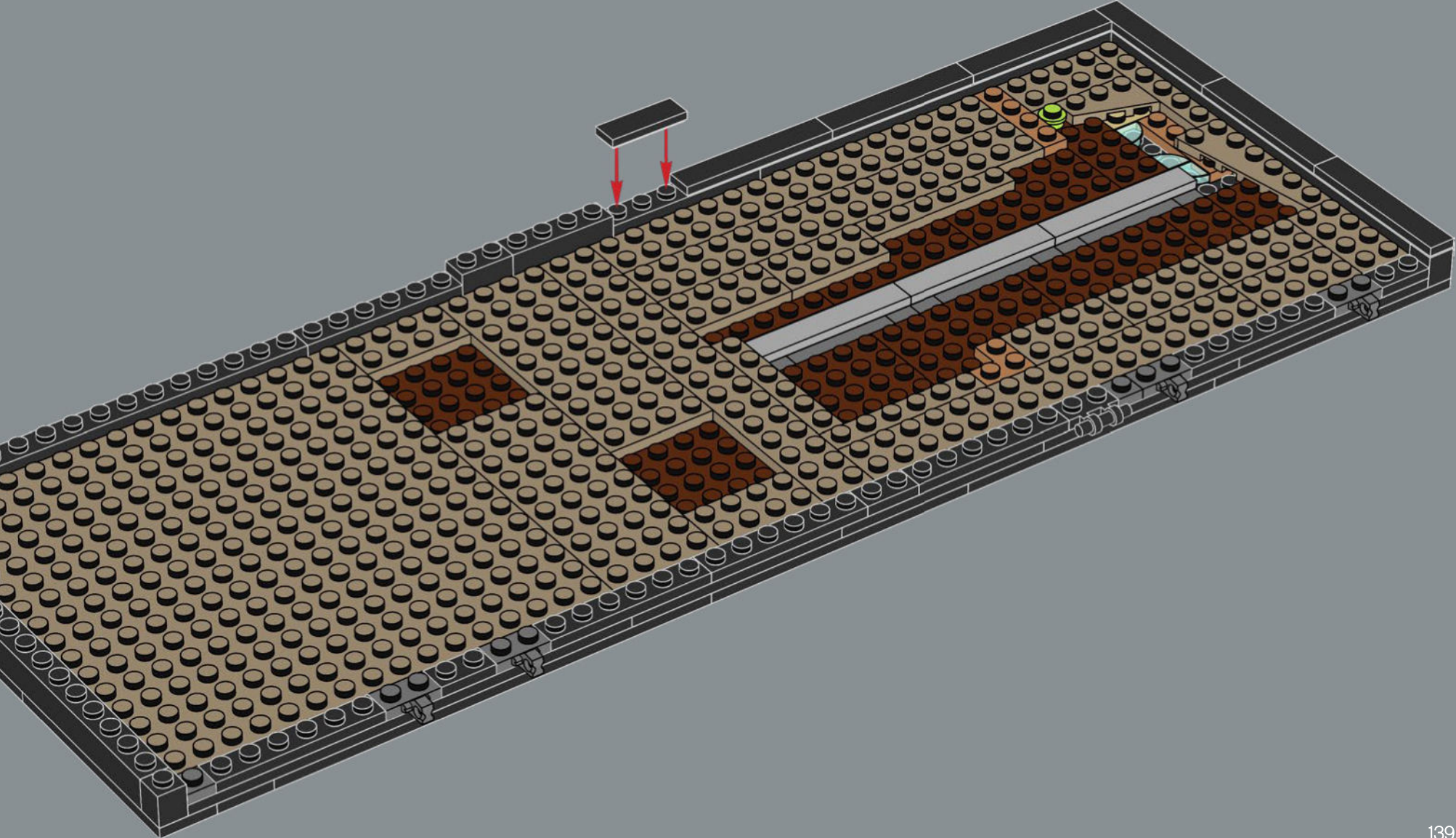

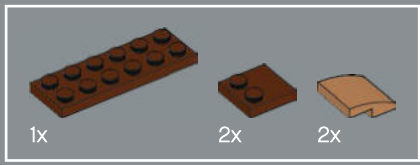

35

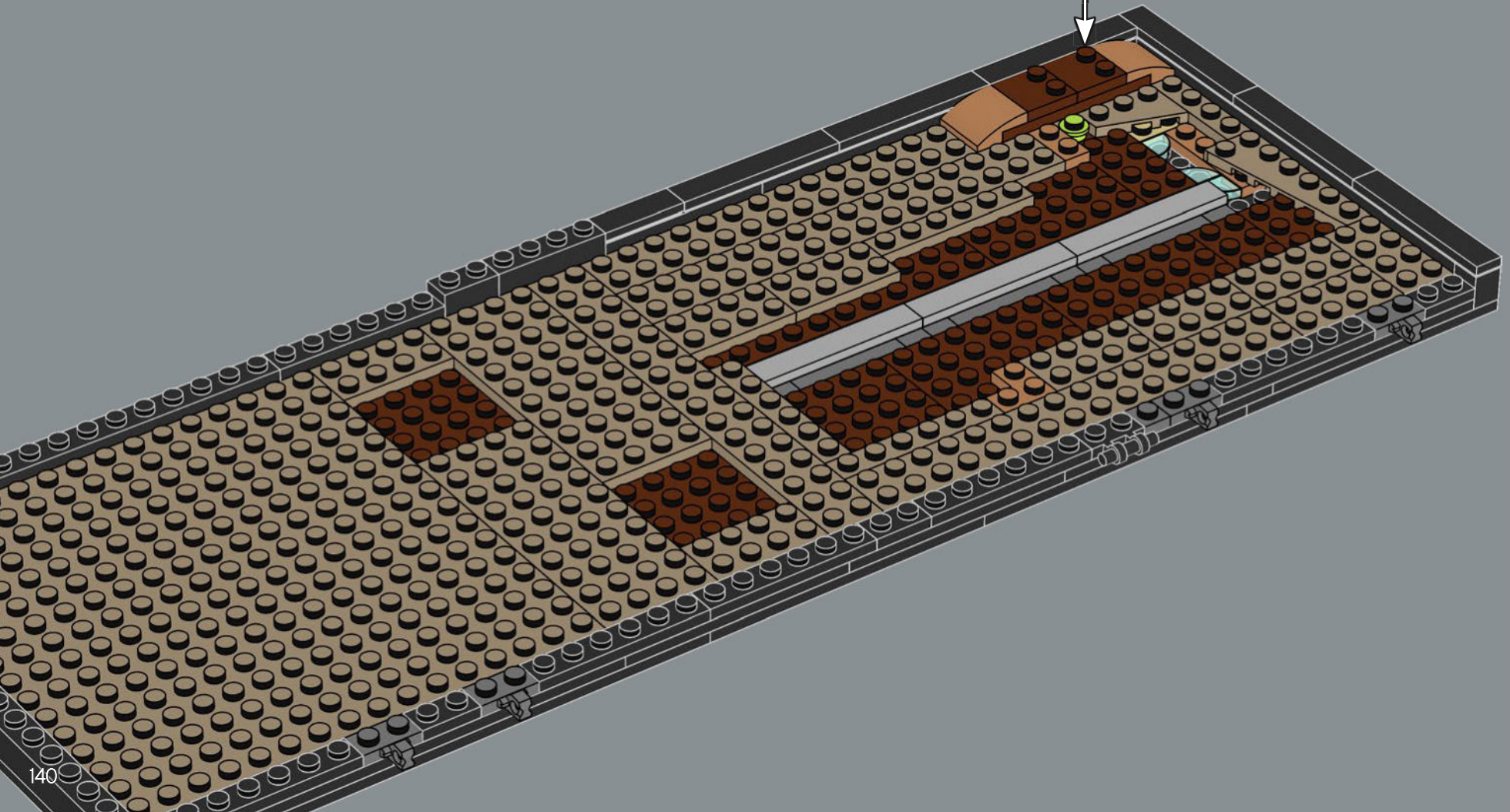
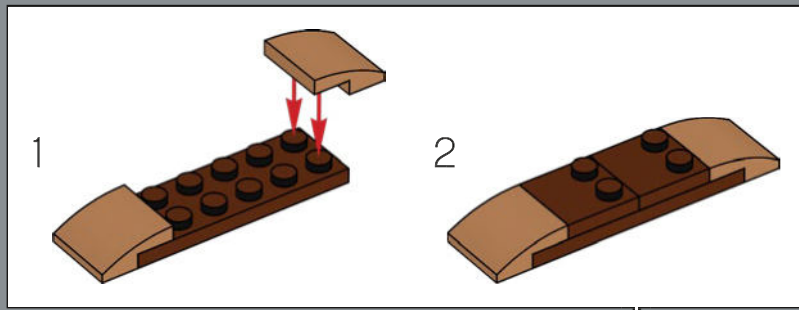

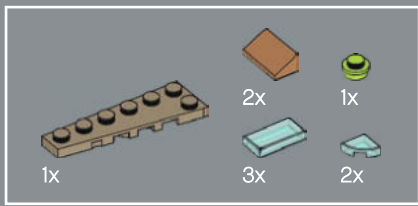

36

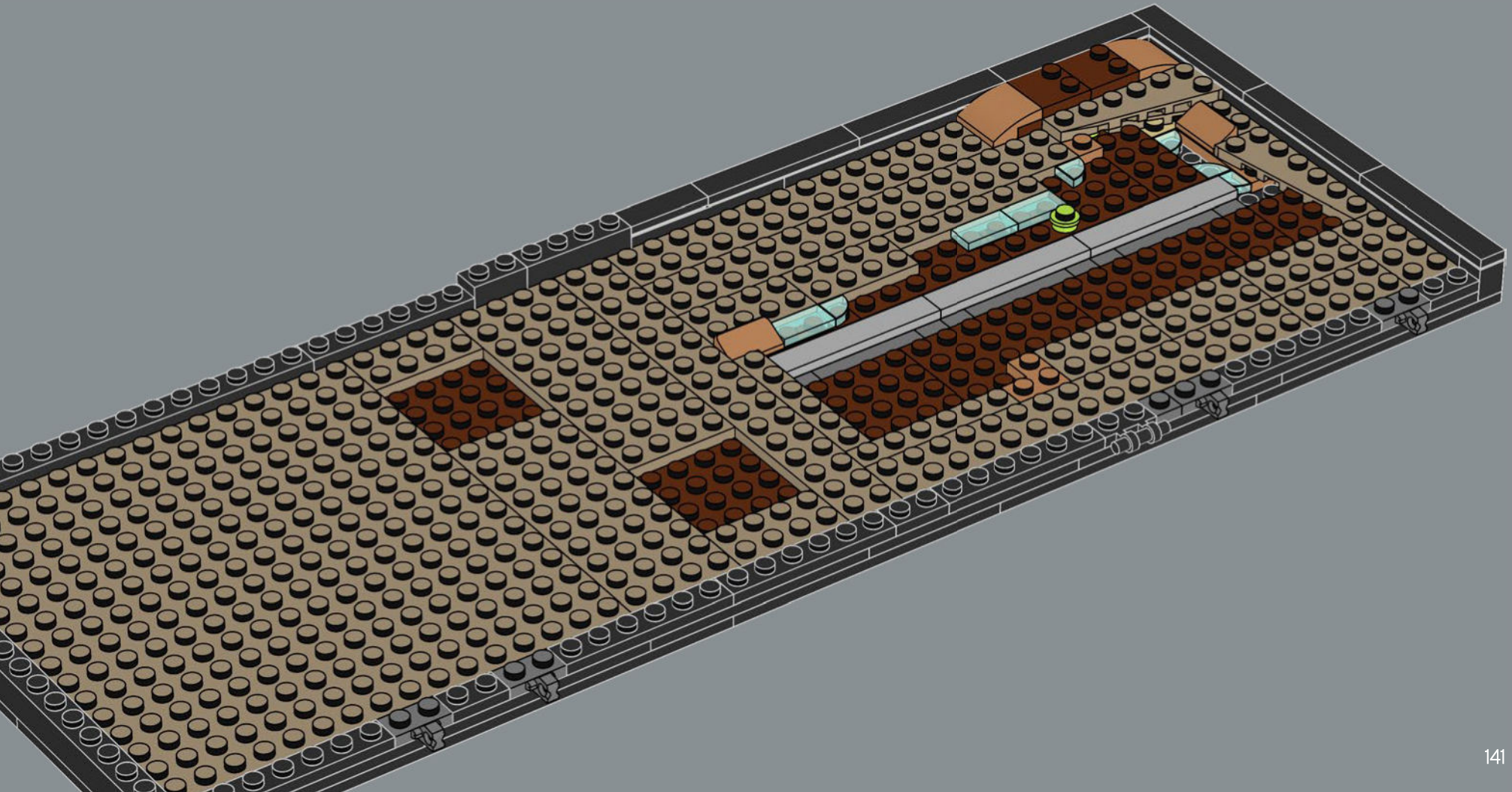

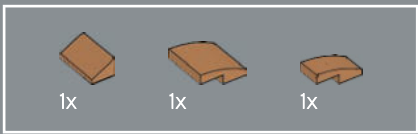

37

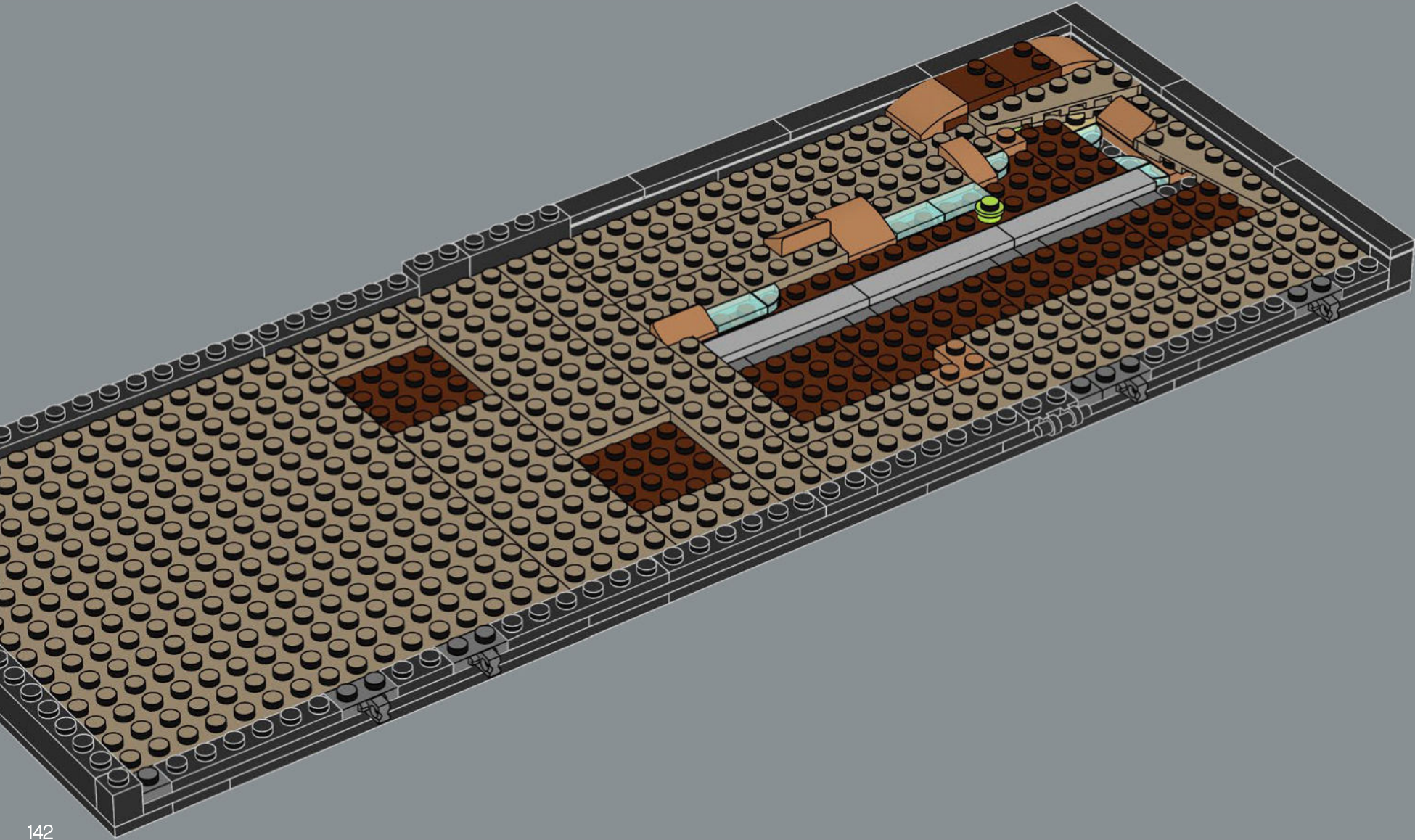

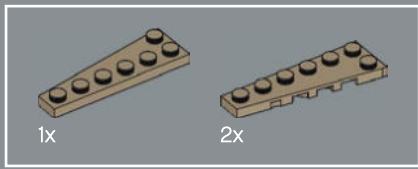

38

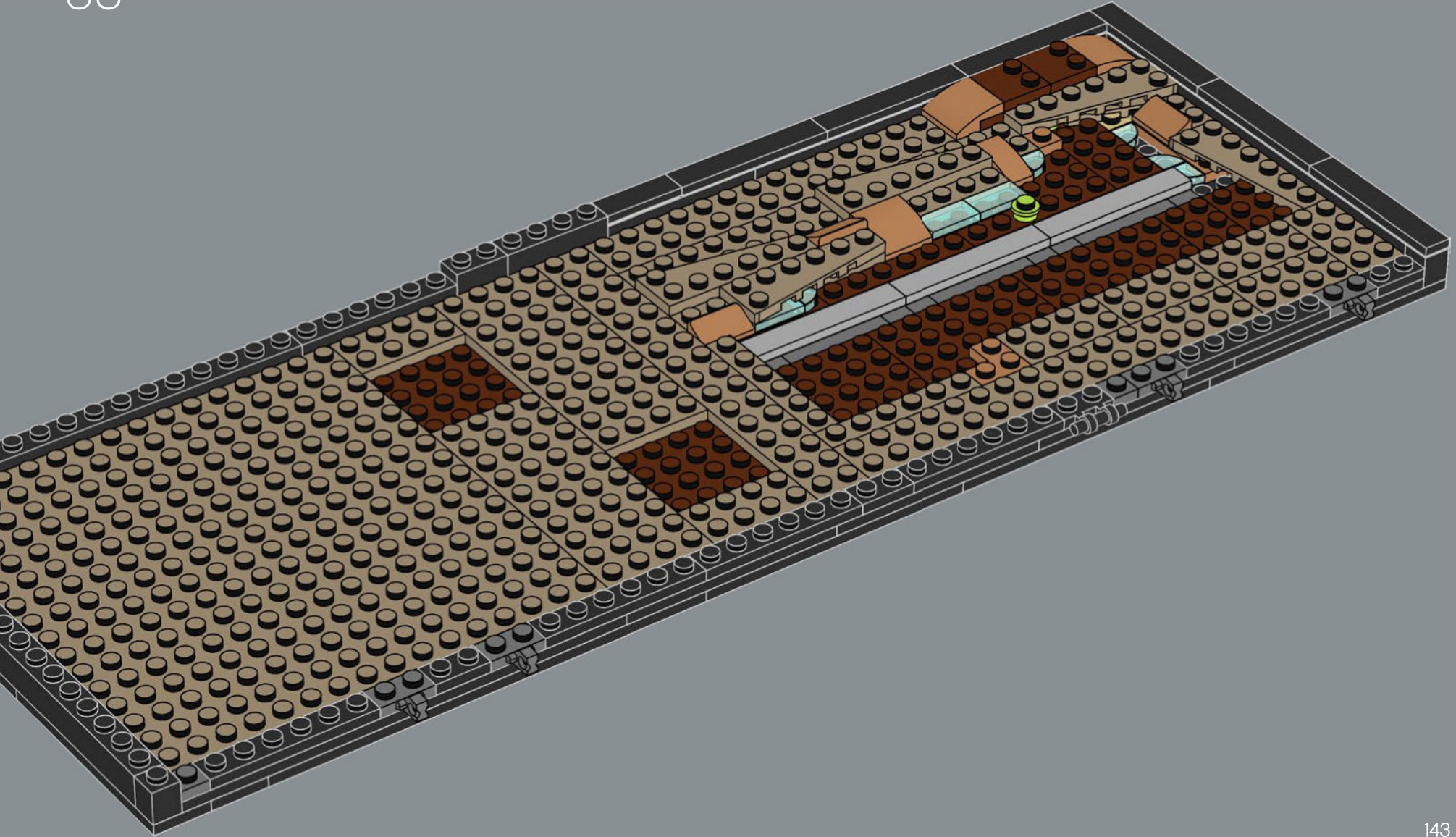

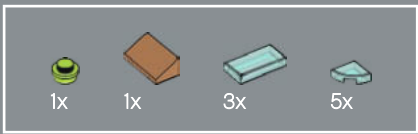

39

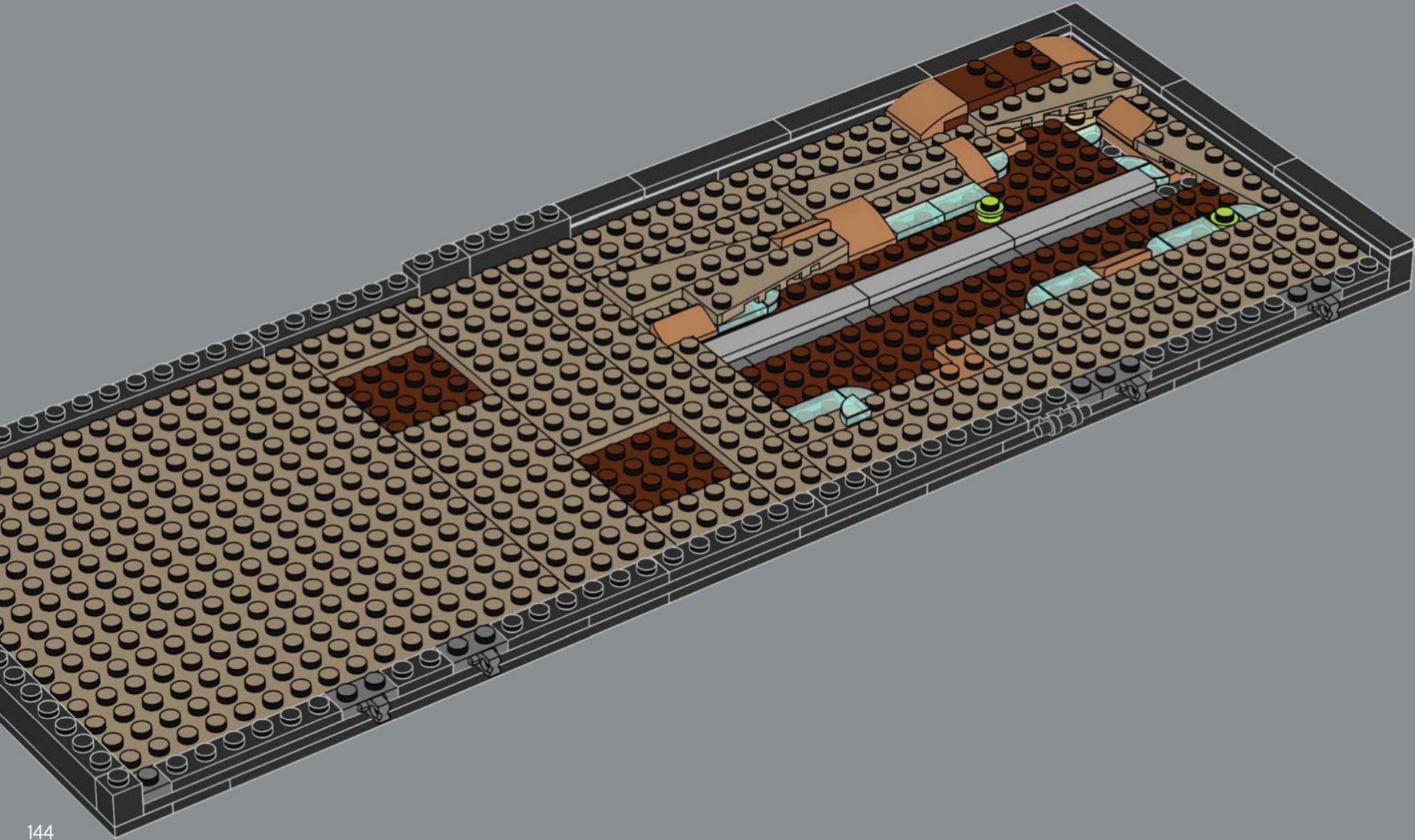

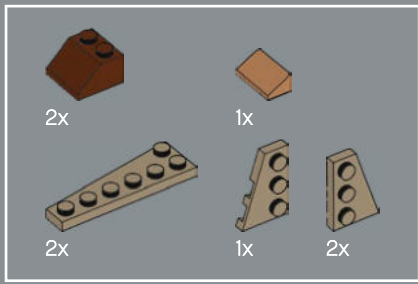

40

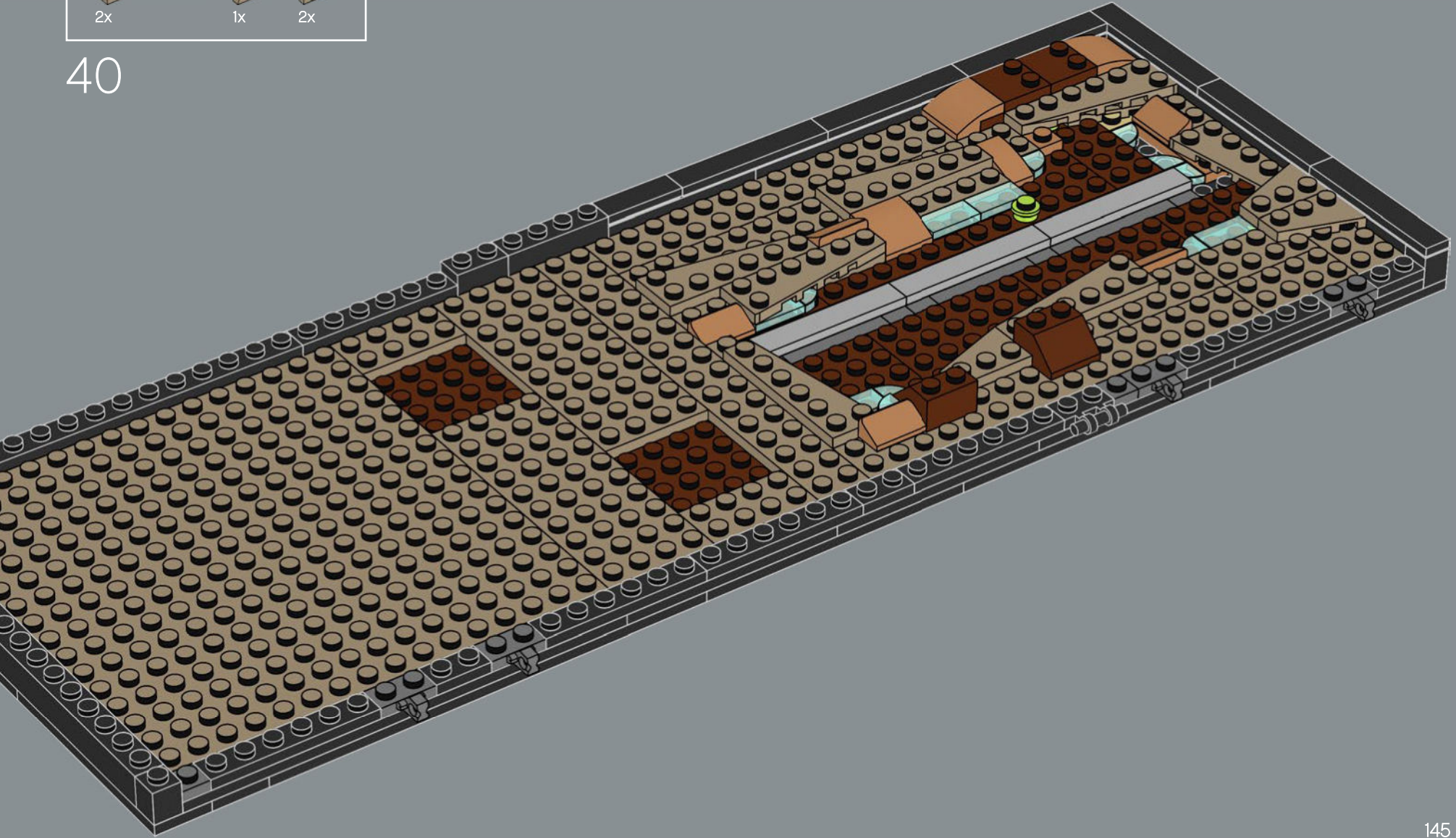

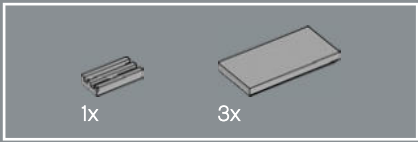

41

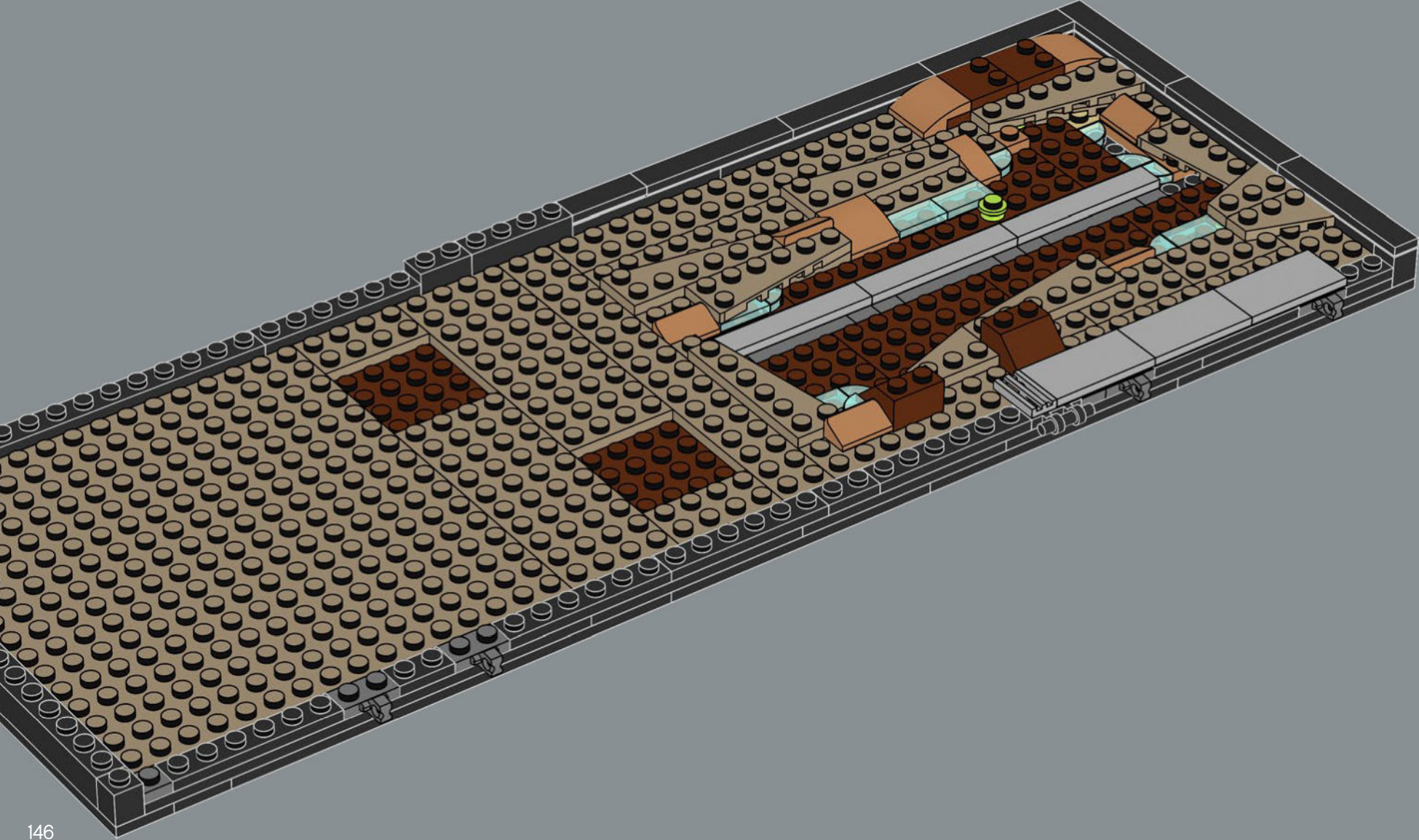

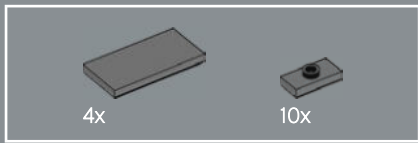

42

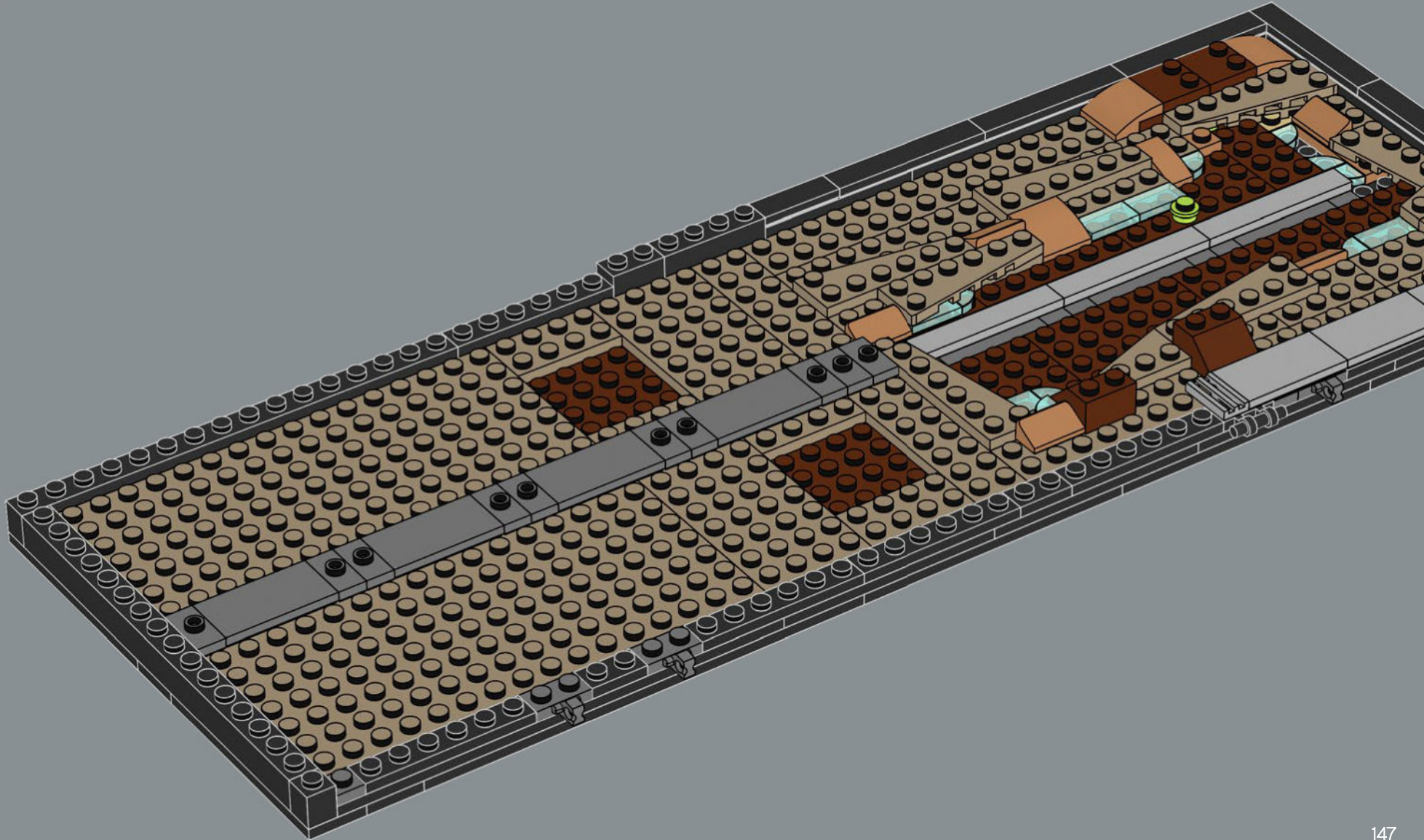

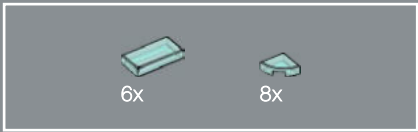

43

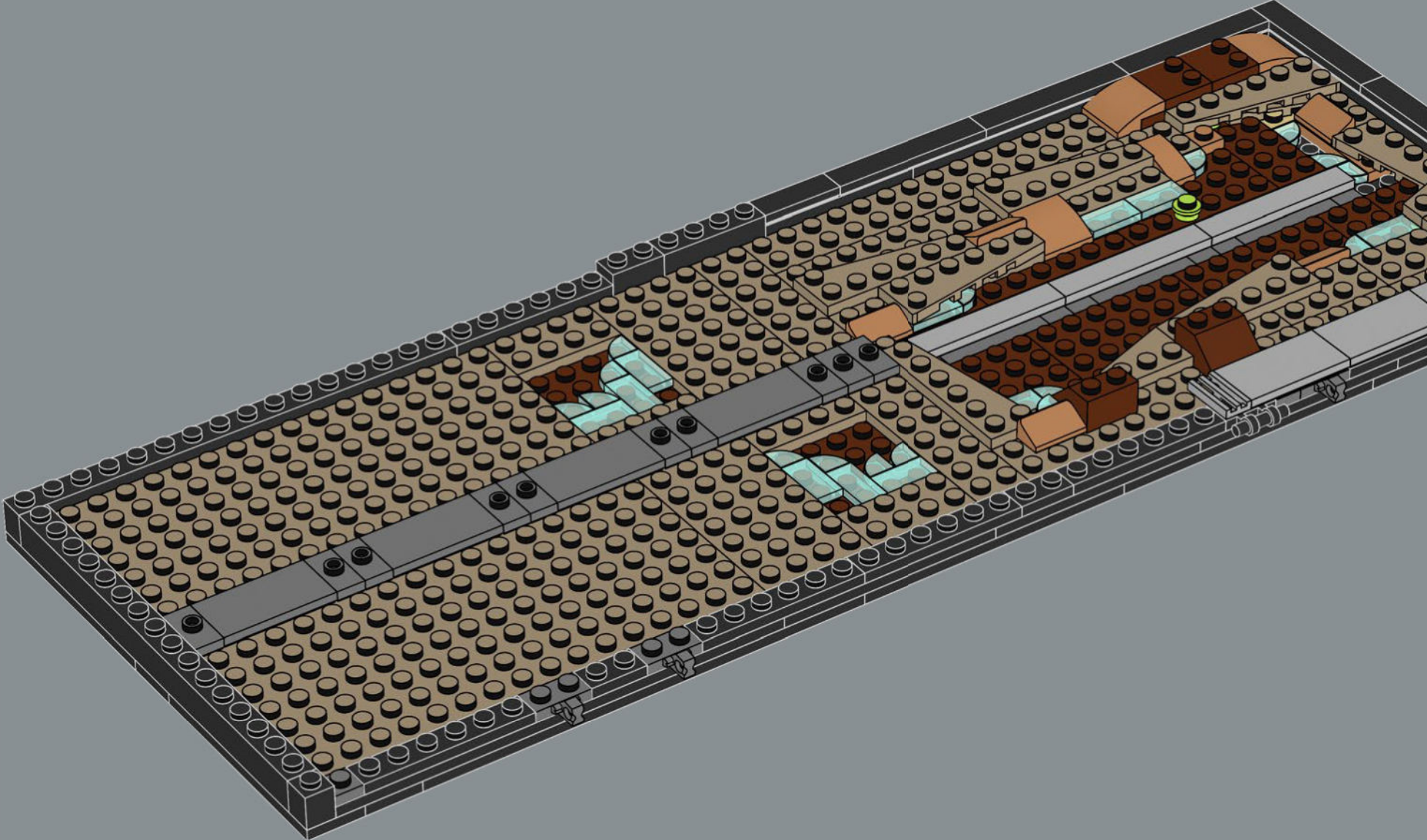

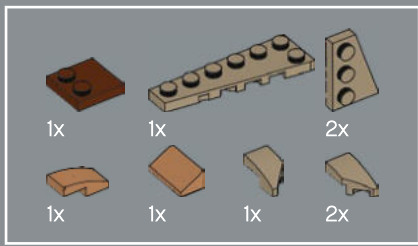

44

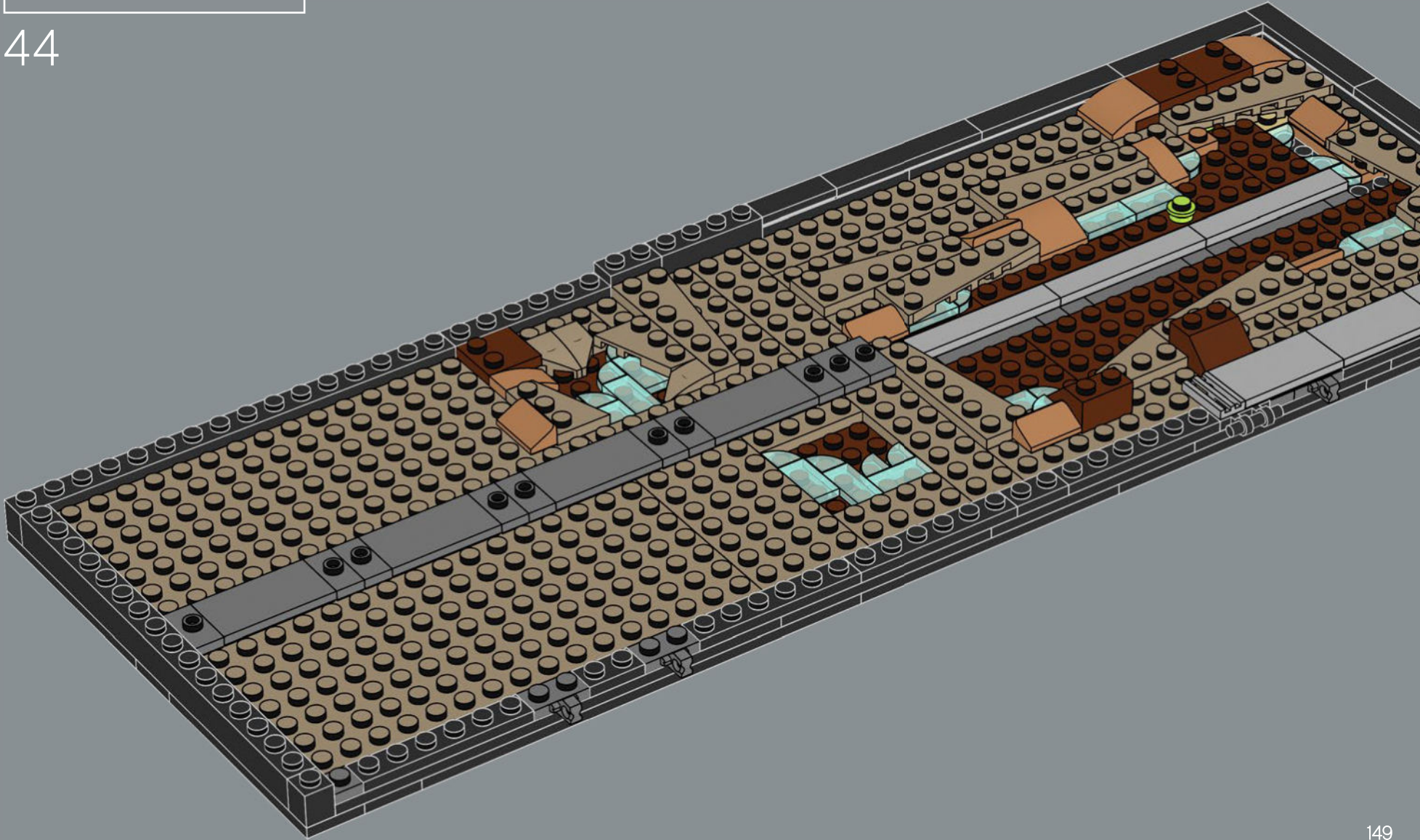

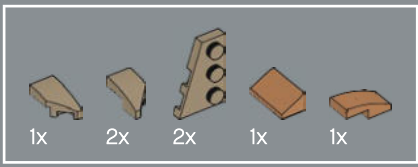

45

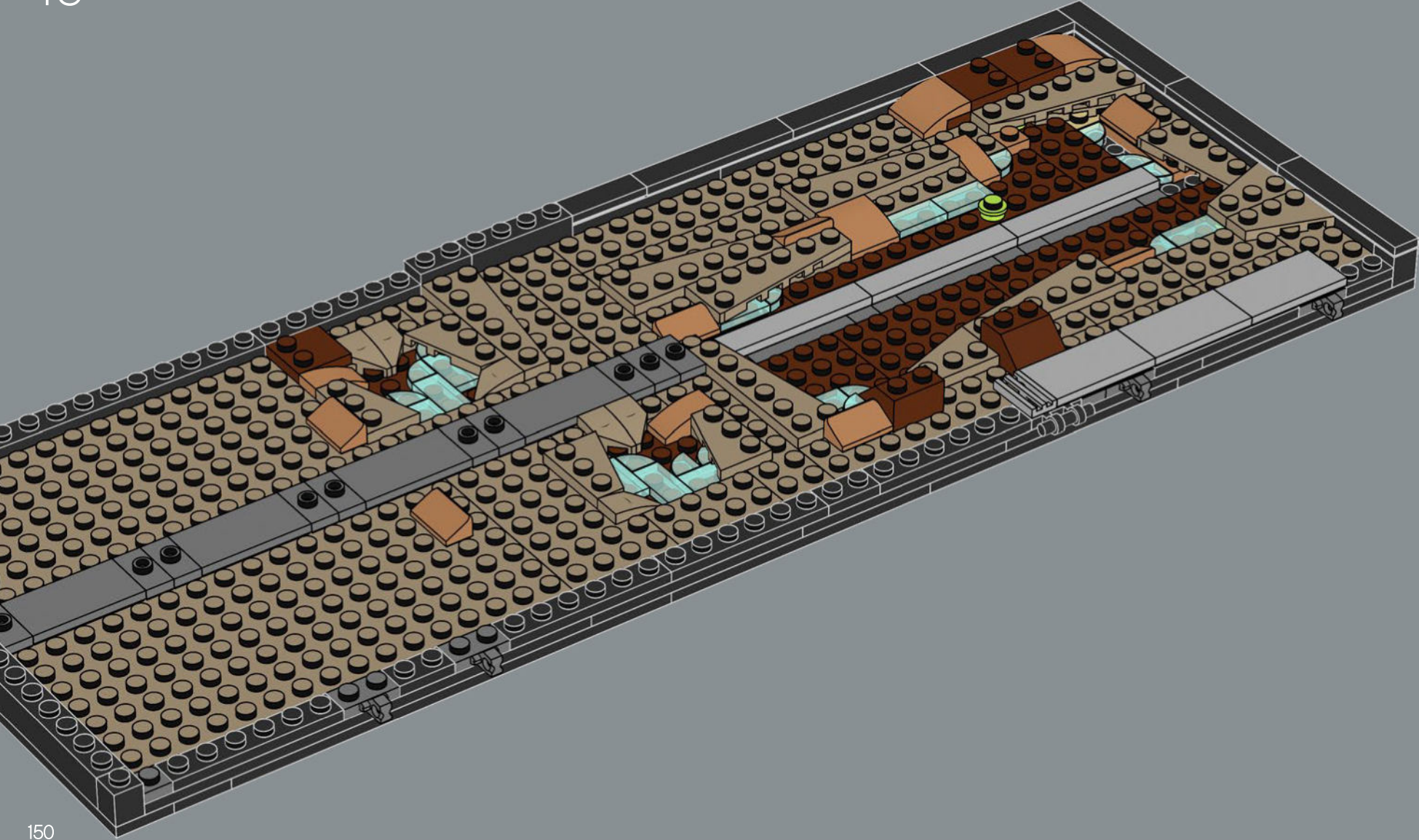



LEAVING A MARK

As a terrified Dr. Grant and Lex cover and desperately try to remain still and quiet, the T. rex stamps its foot down into the mud, creating giant footprints.

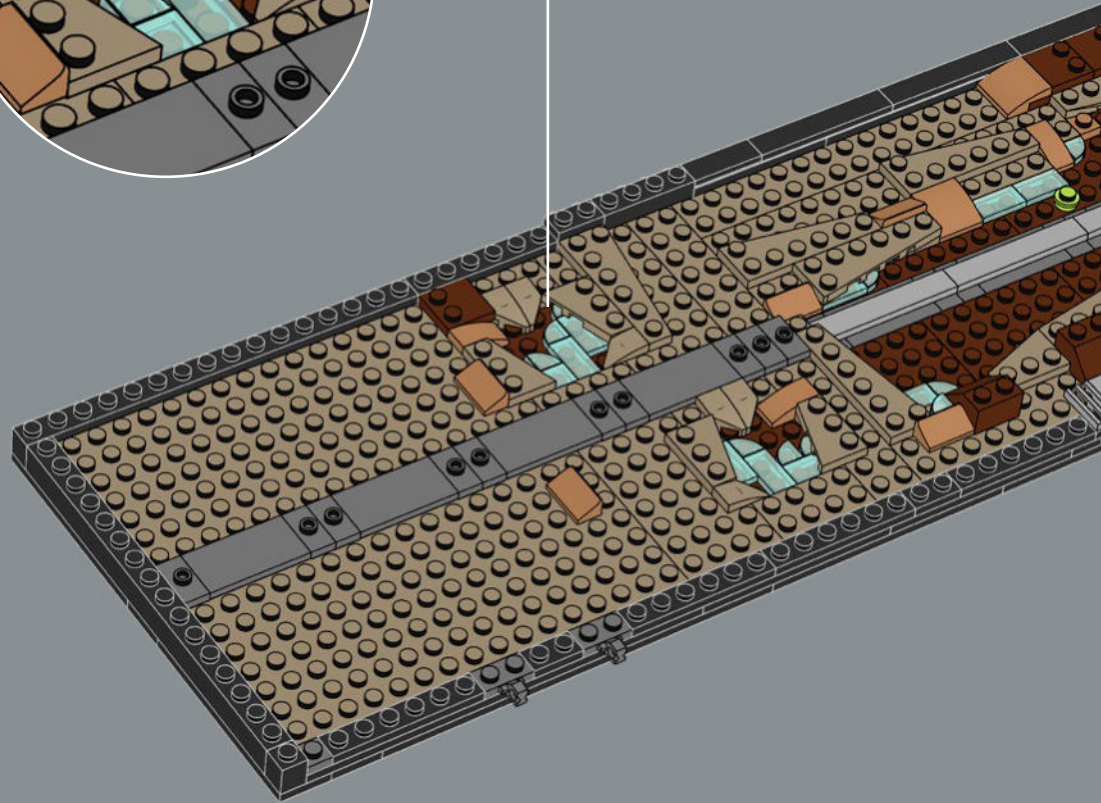
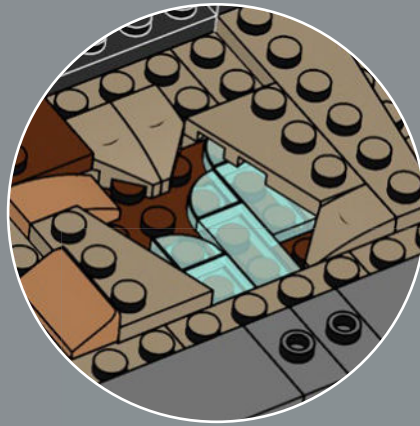

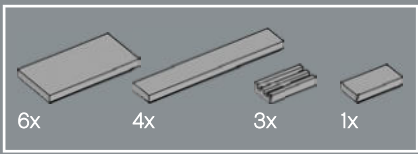

46

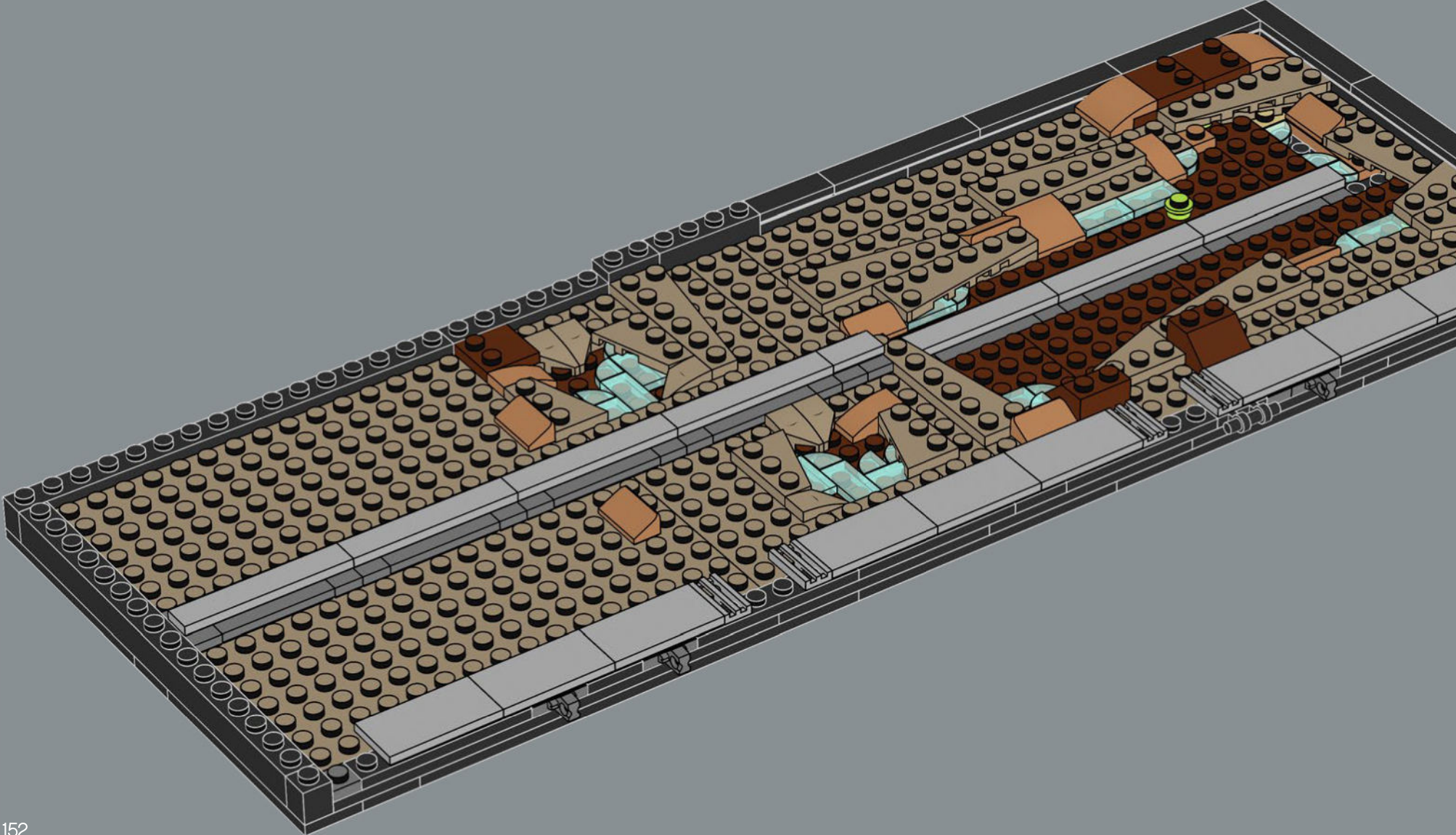

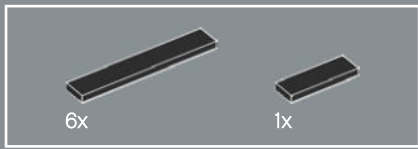

47

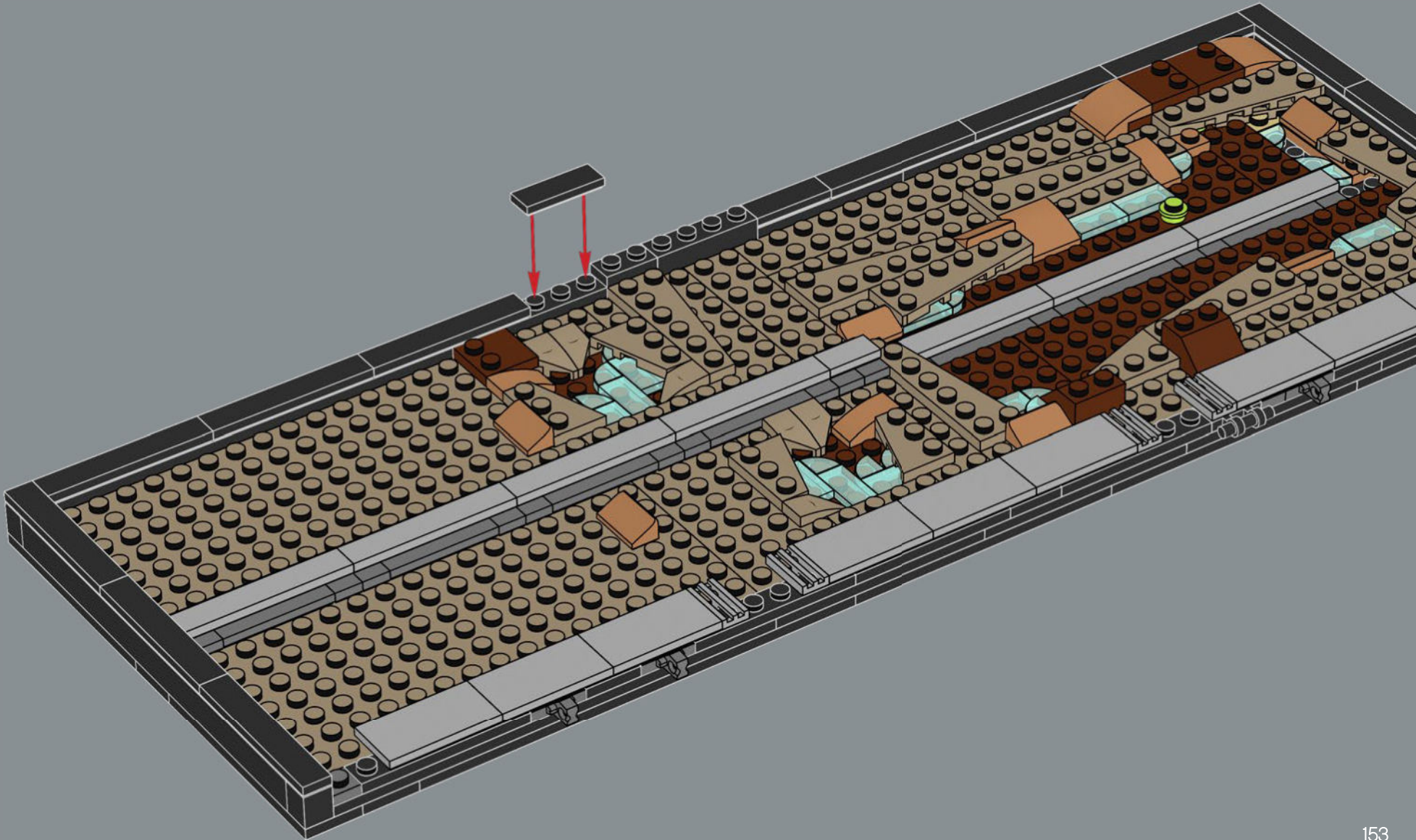

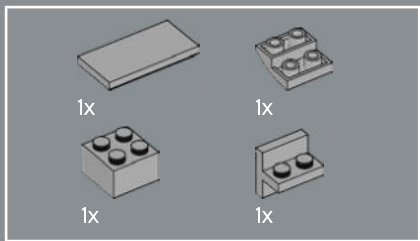

48

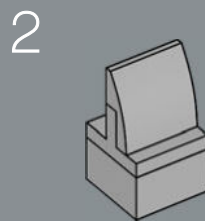
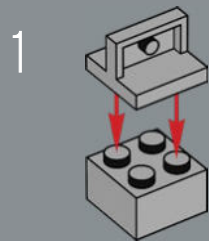

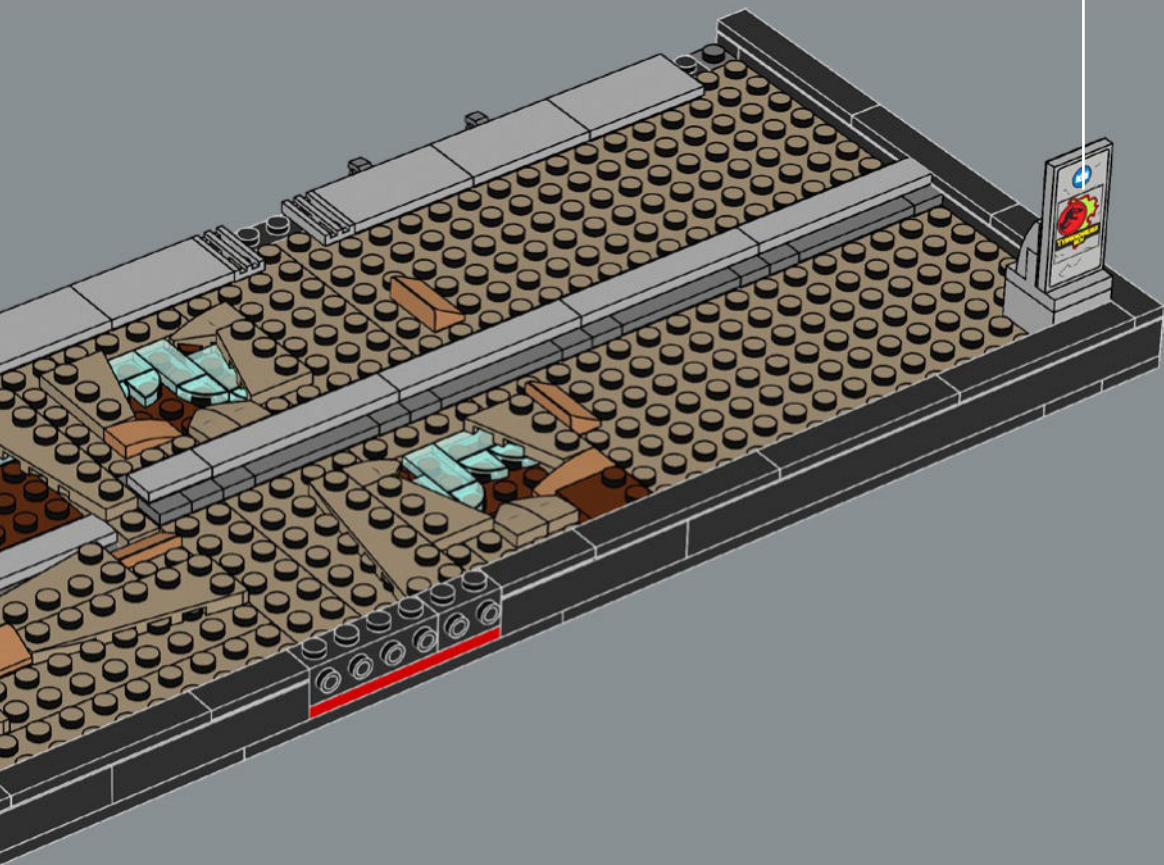

THE MAIN EVENT

Finally, we made it to the T. rex paddock, the main attraction at Jurassic Park!
What could possibly go wrong?

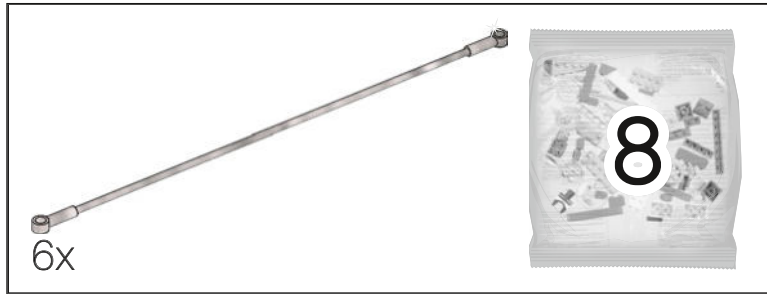

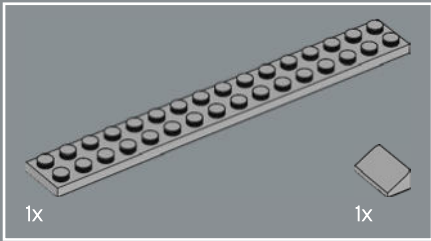
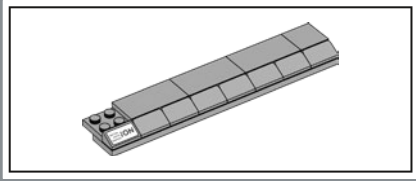
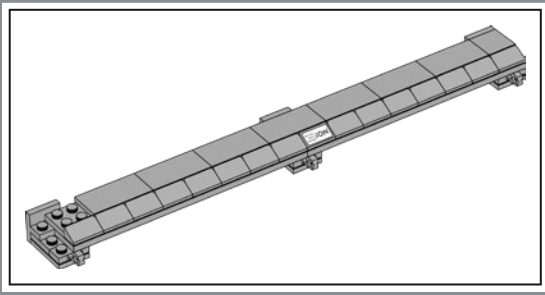

49

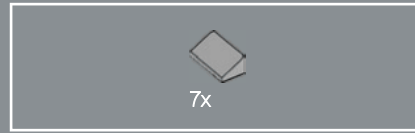
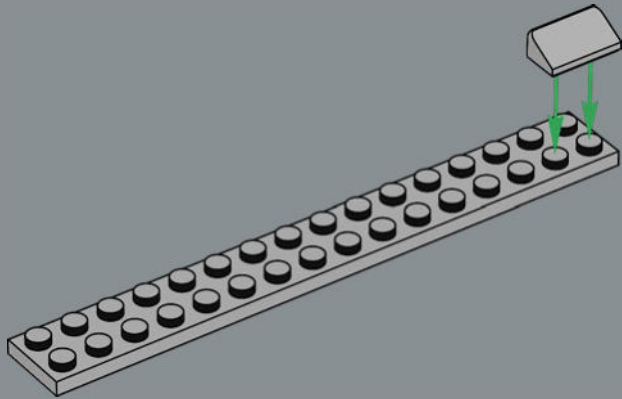

50

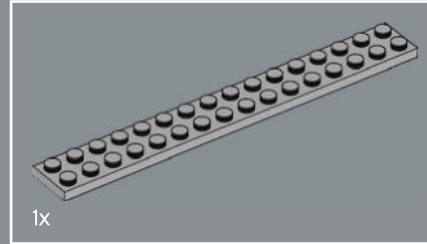
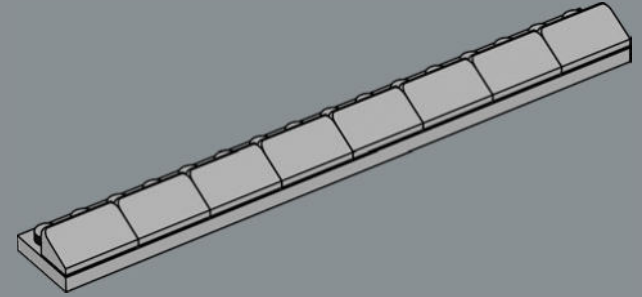

51

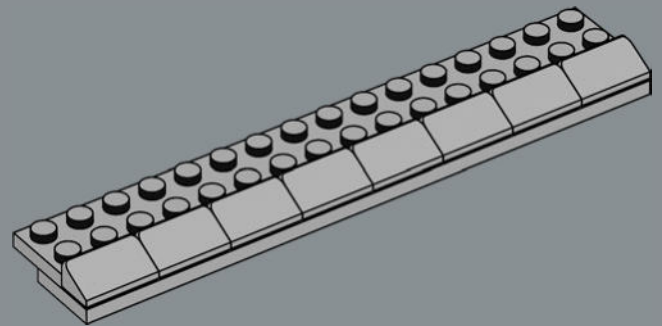

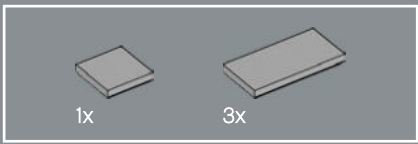

52

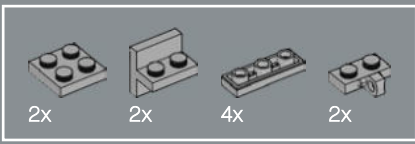
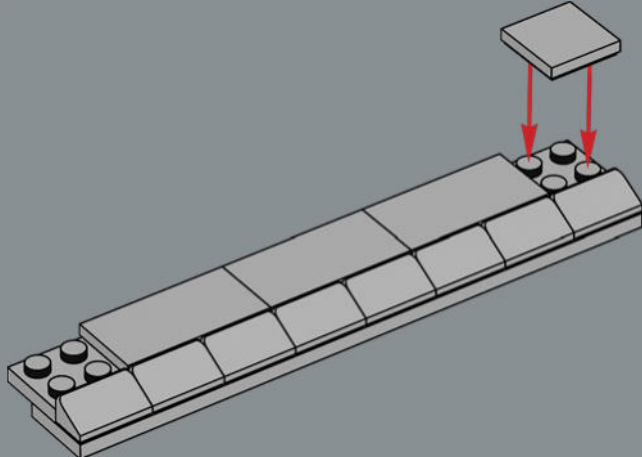

54

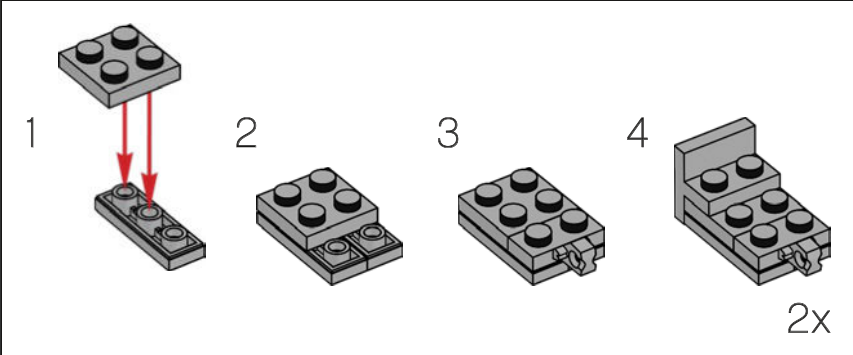

53

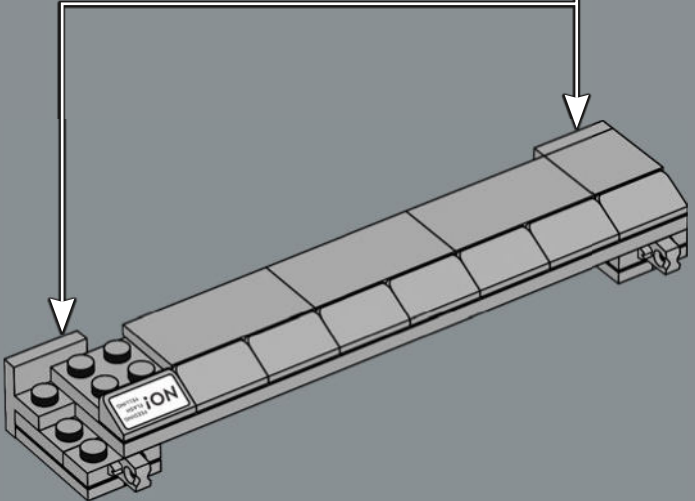
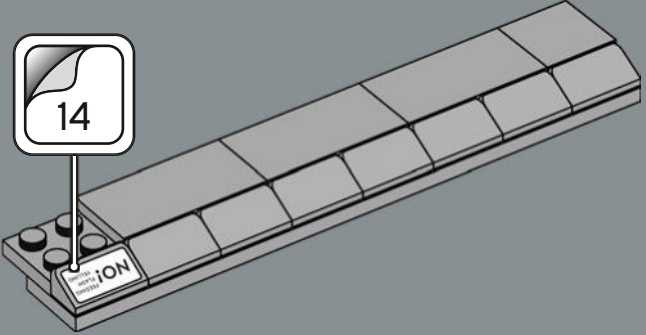

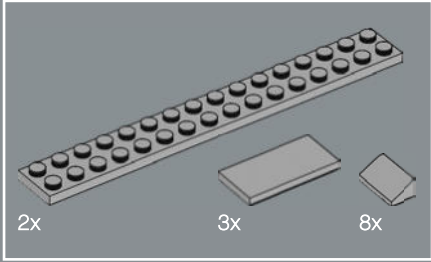
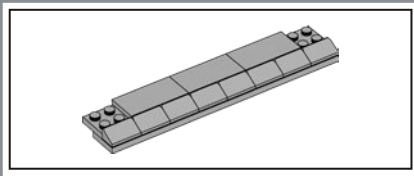

55

1

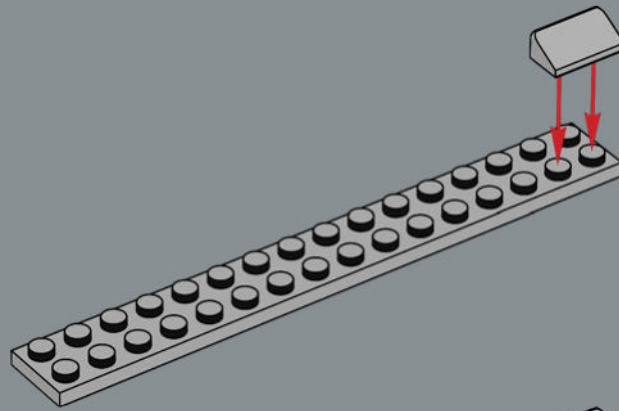

2

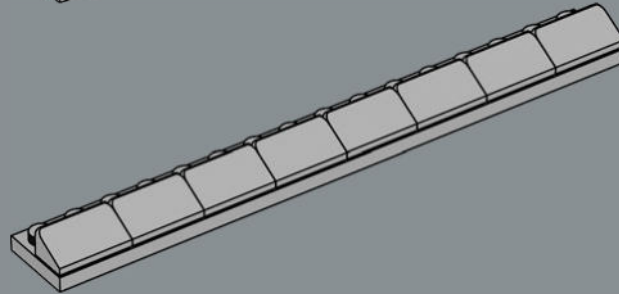

3

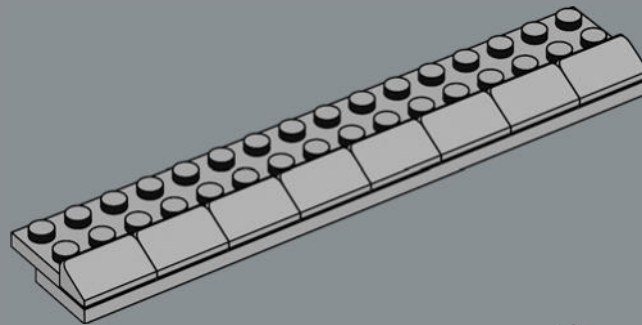

4

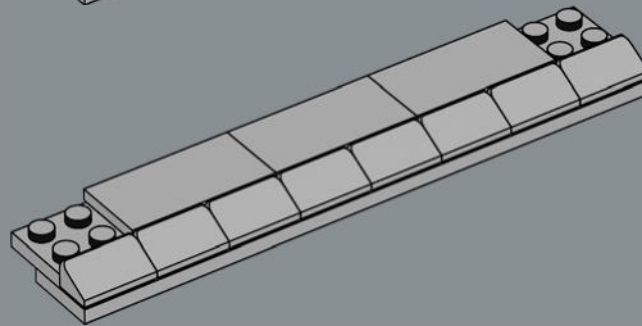

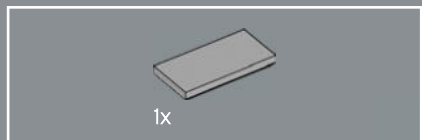
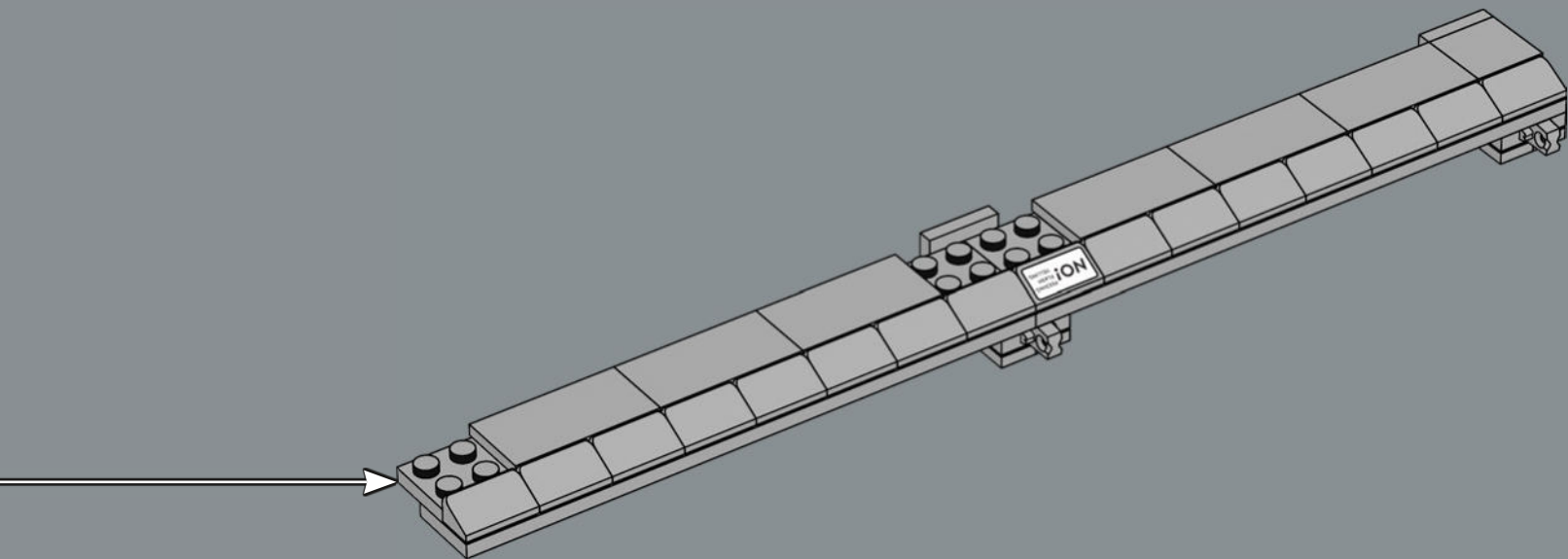

56

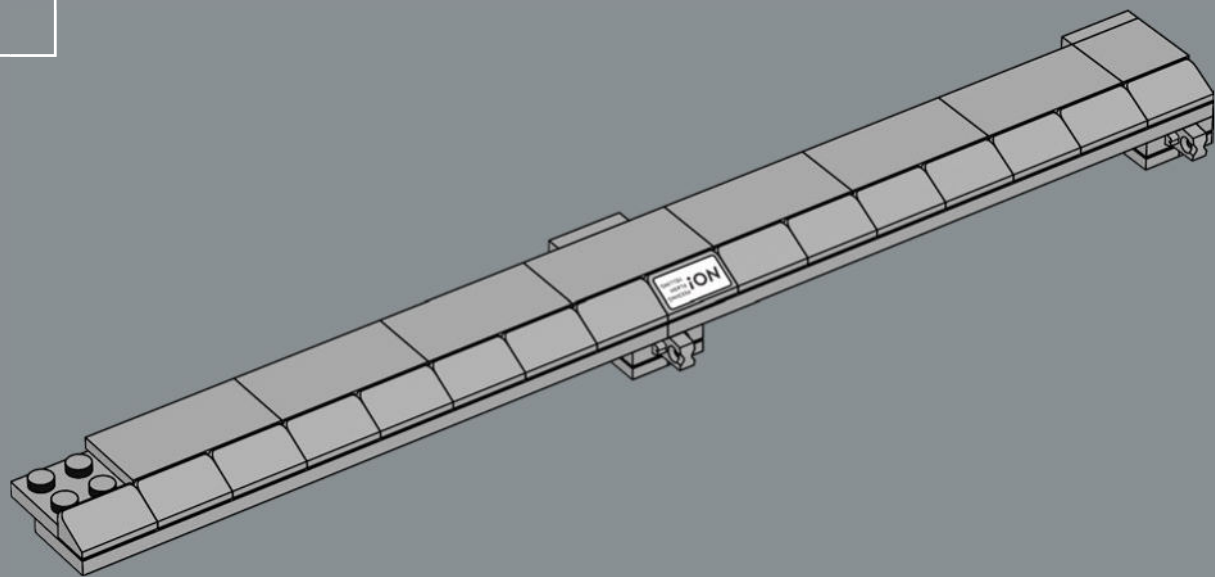

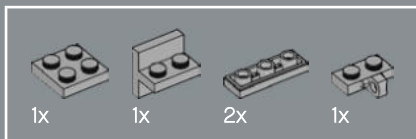

57

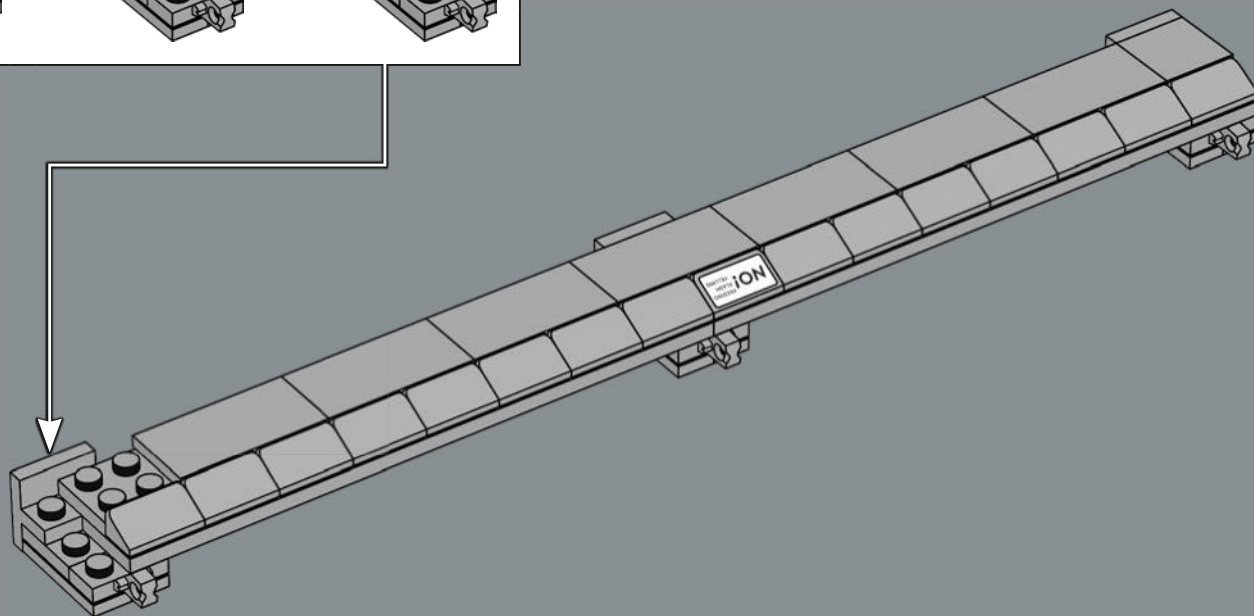
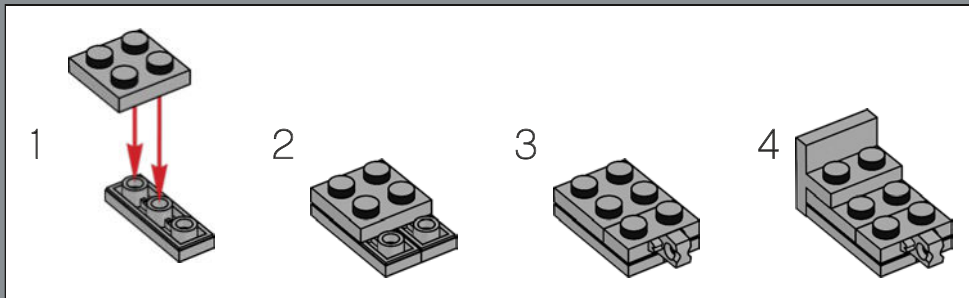

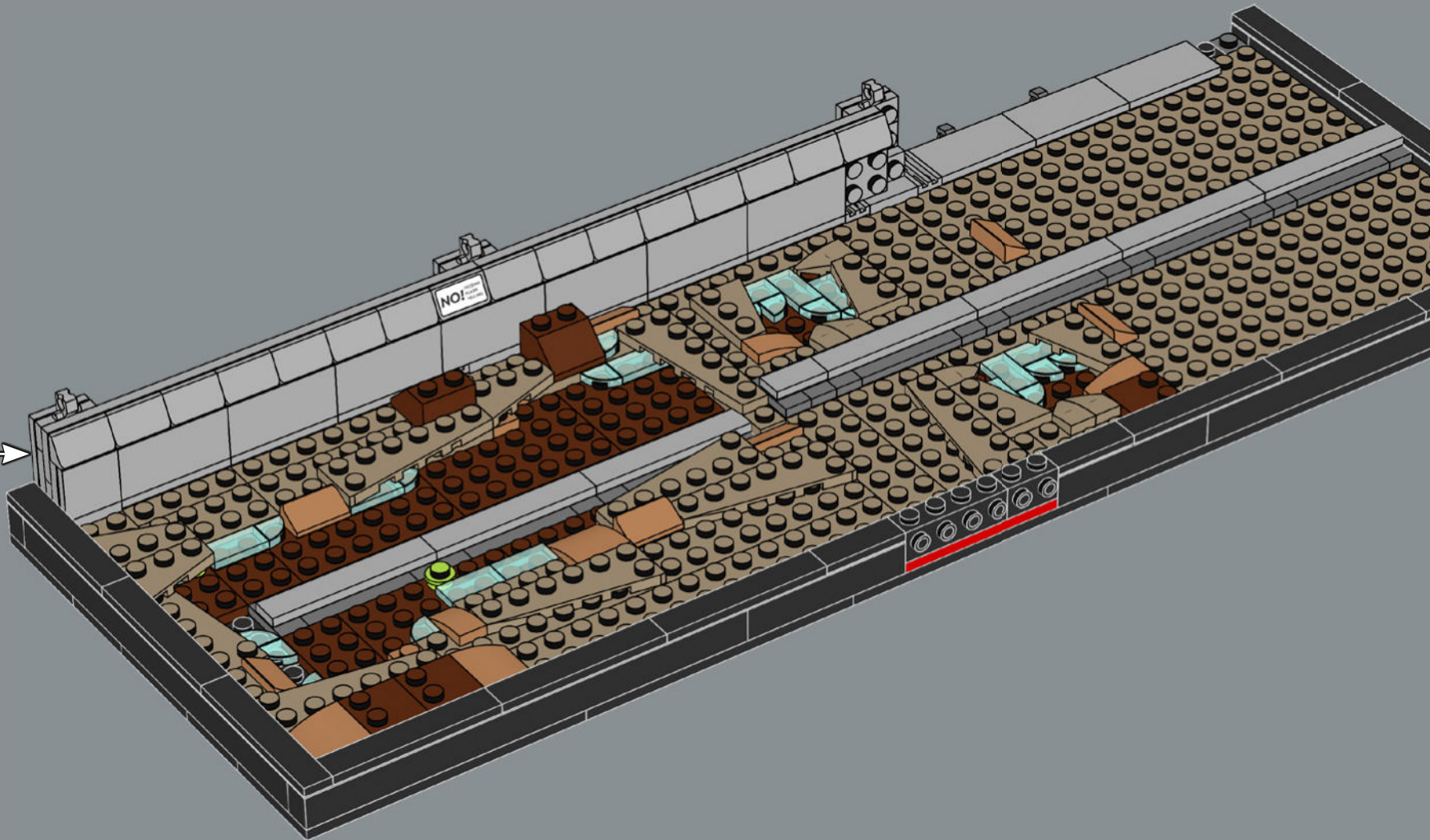

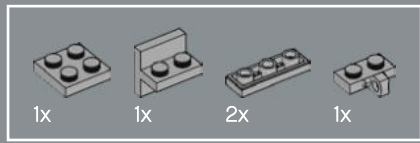

59

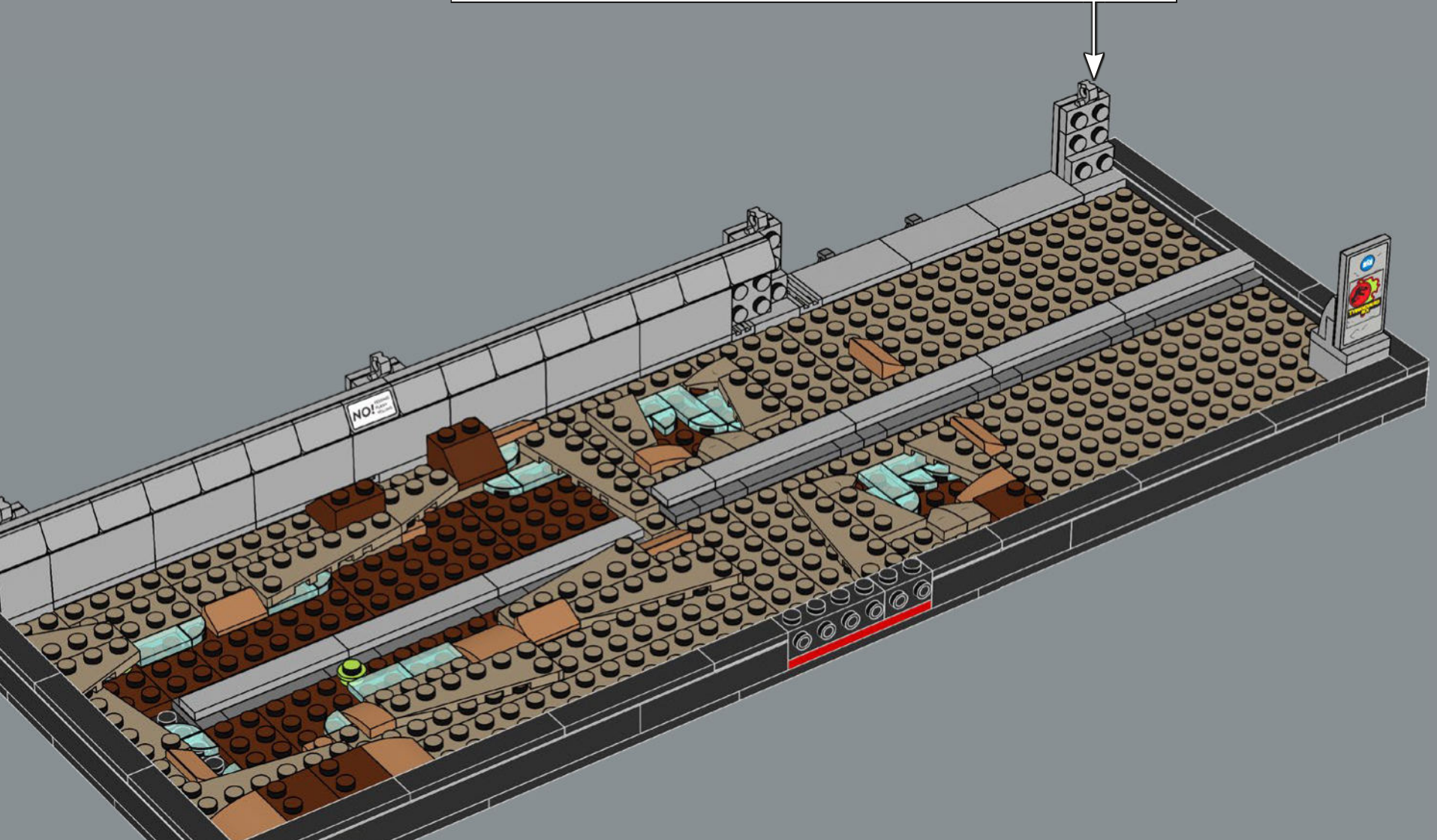
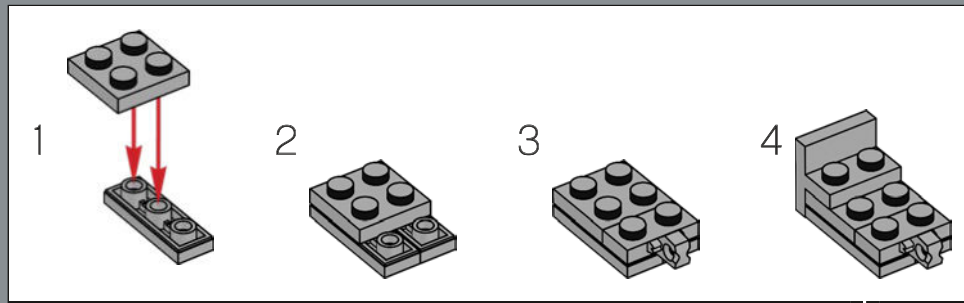

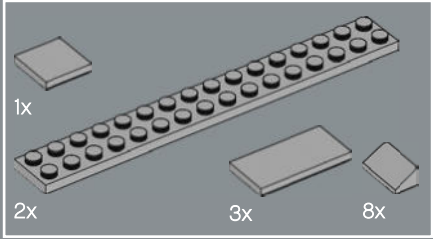
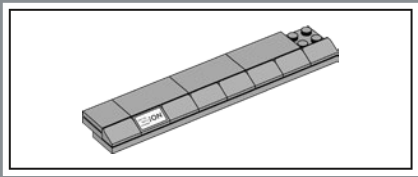

60

1

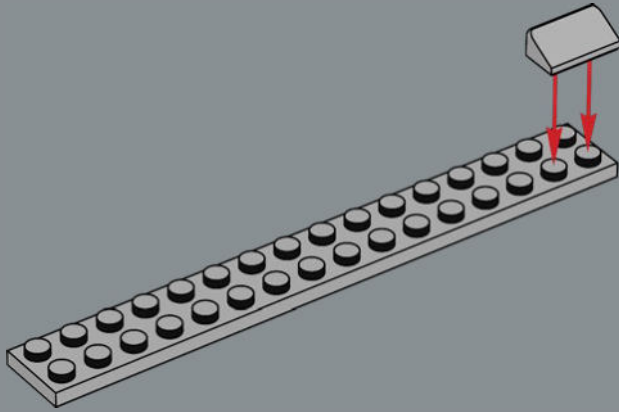

2

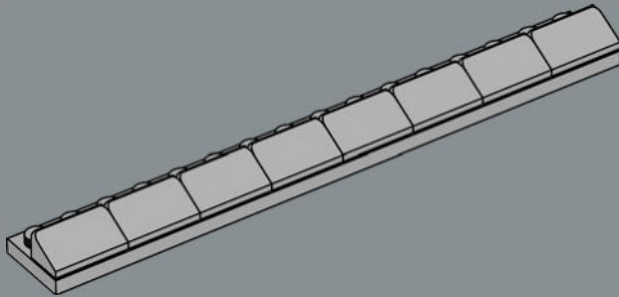

3

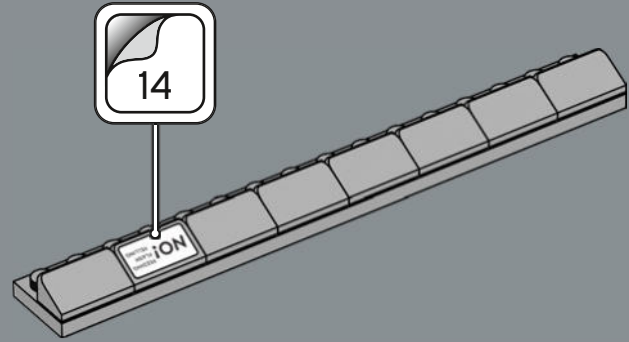

4

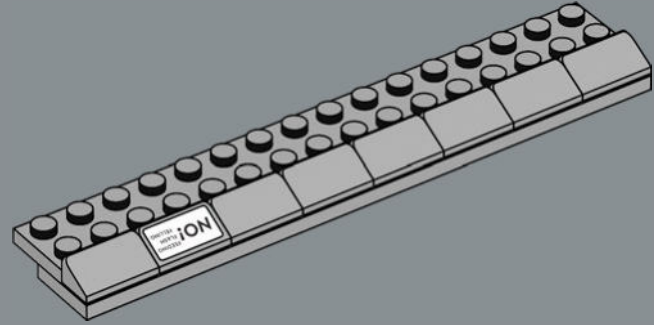

5

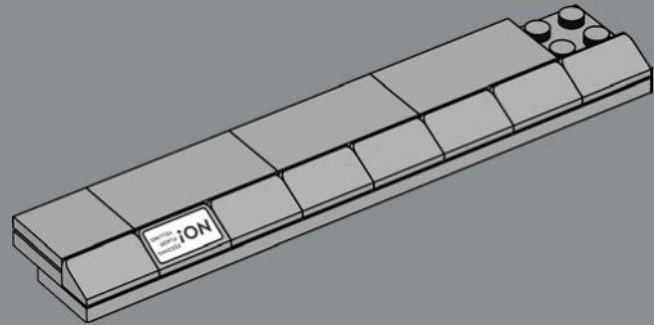

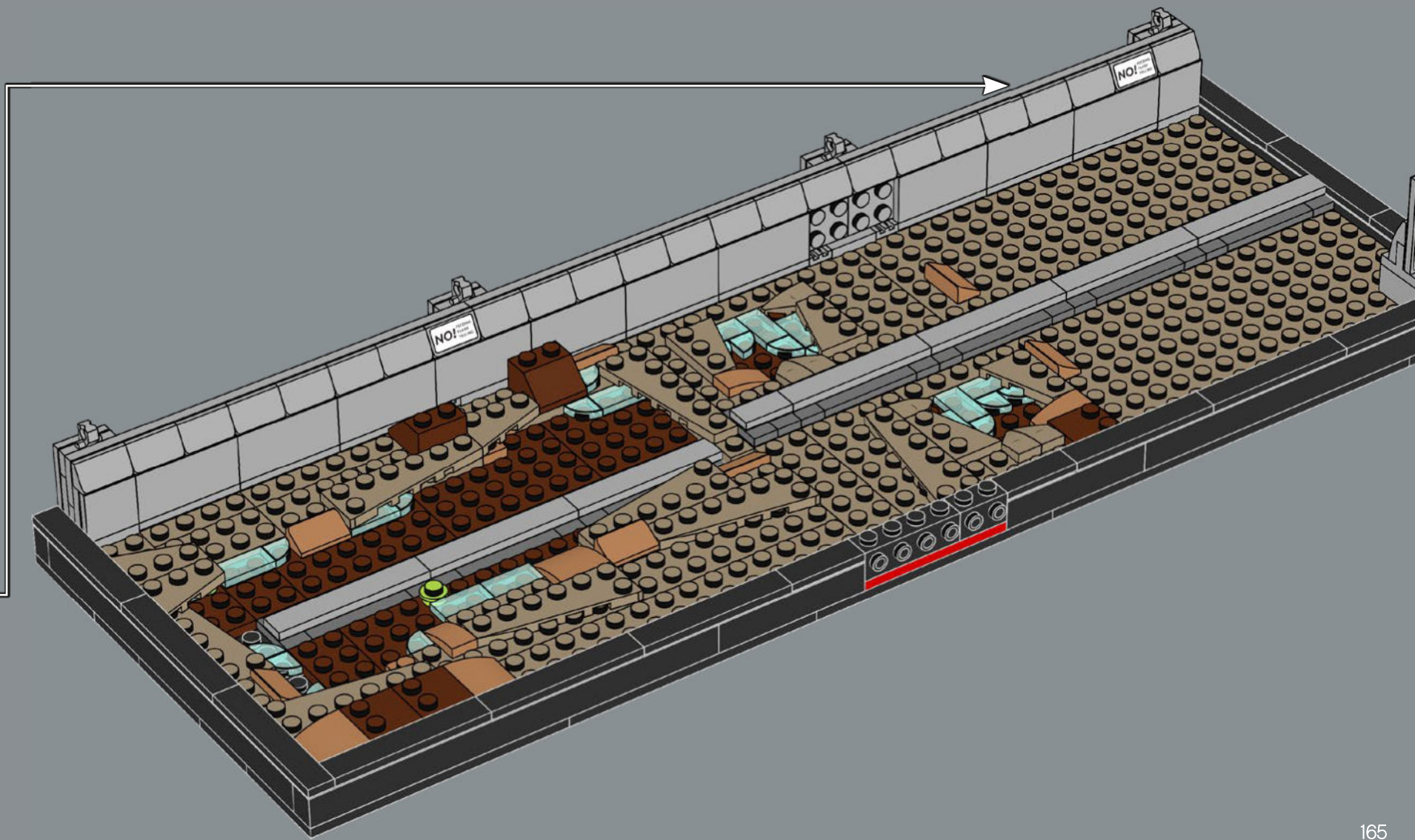

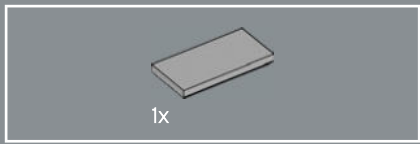

61

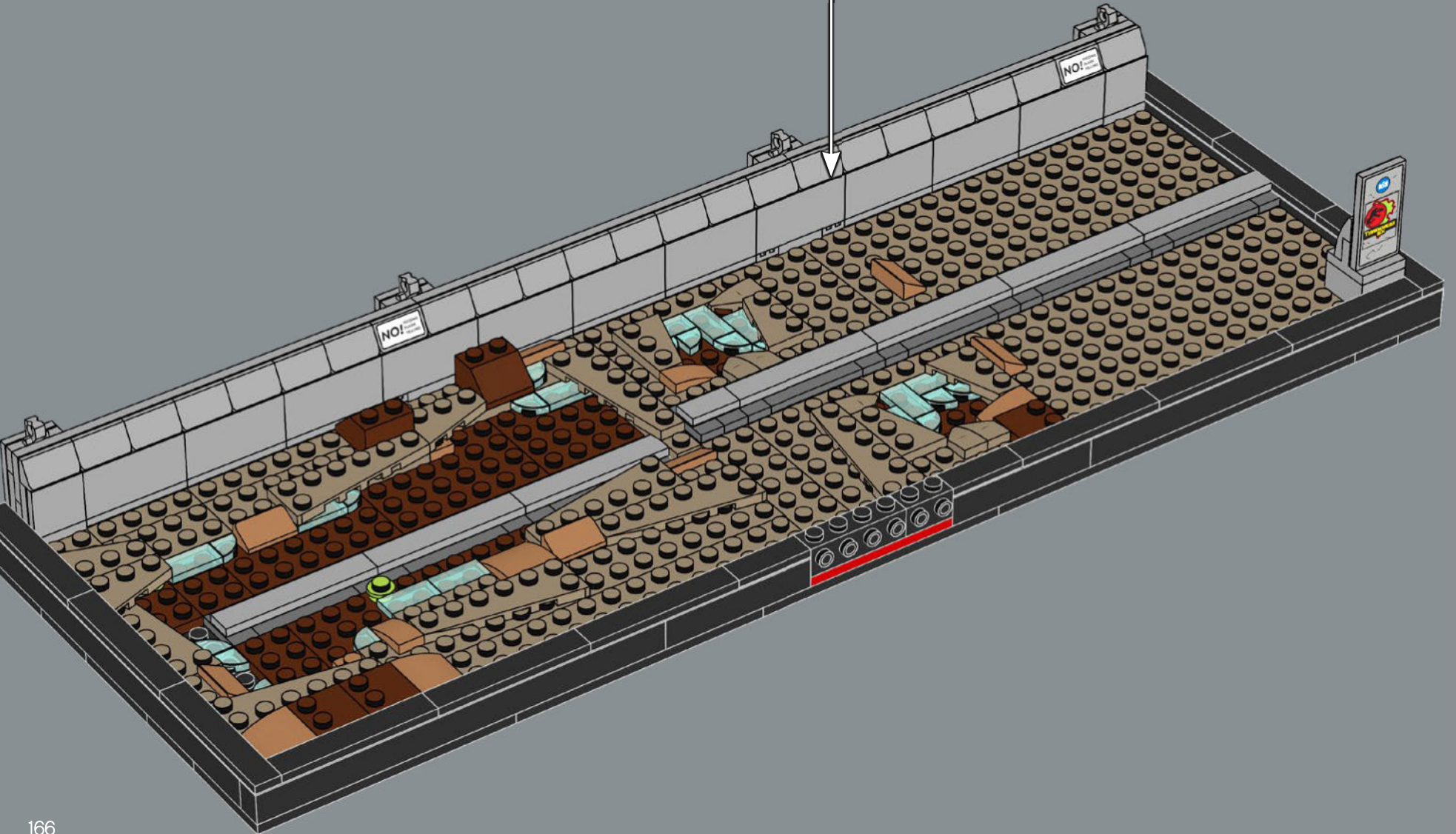
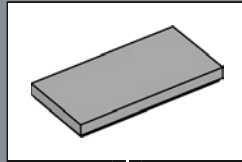

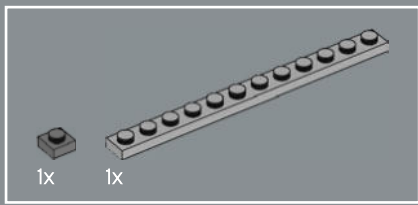

62

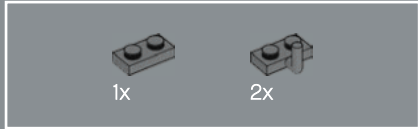
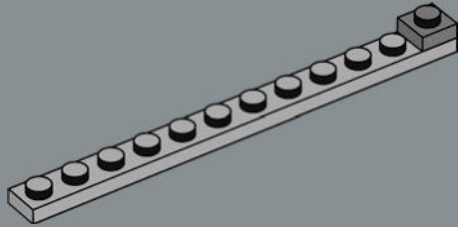

63

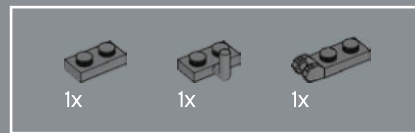
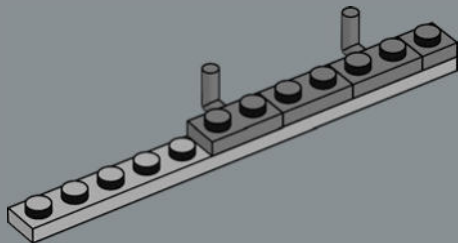

64

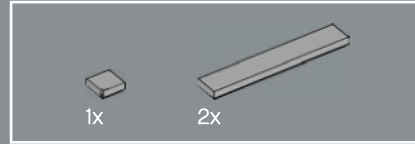
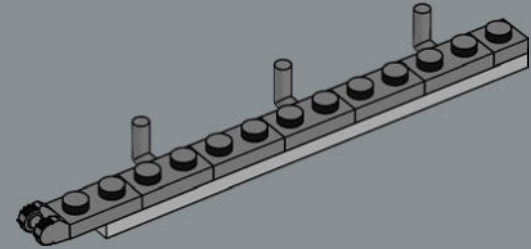

65

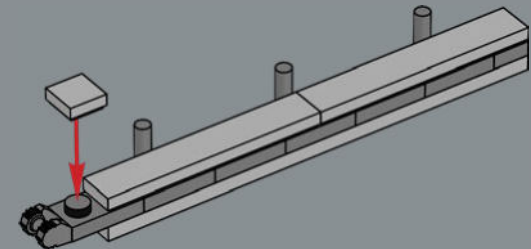

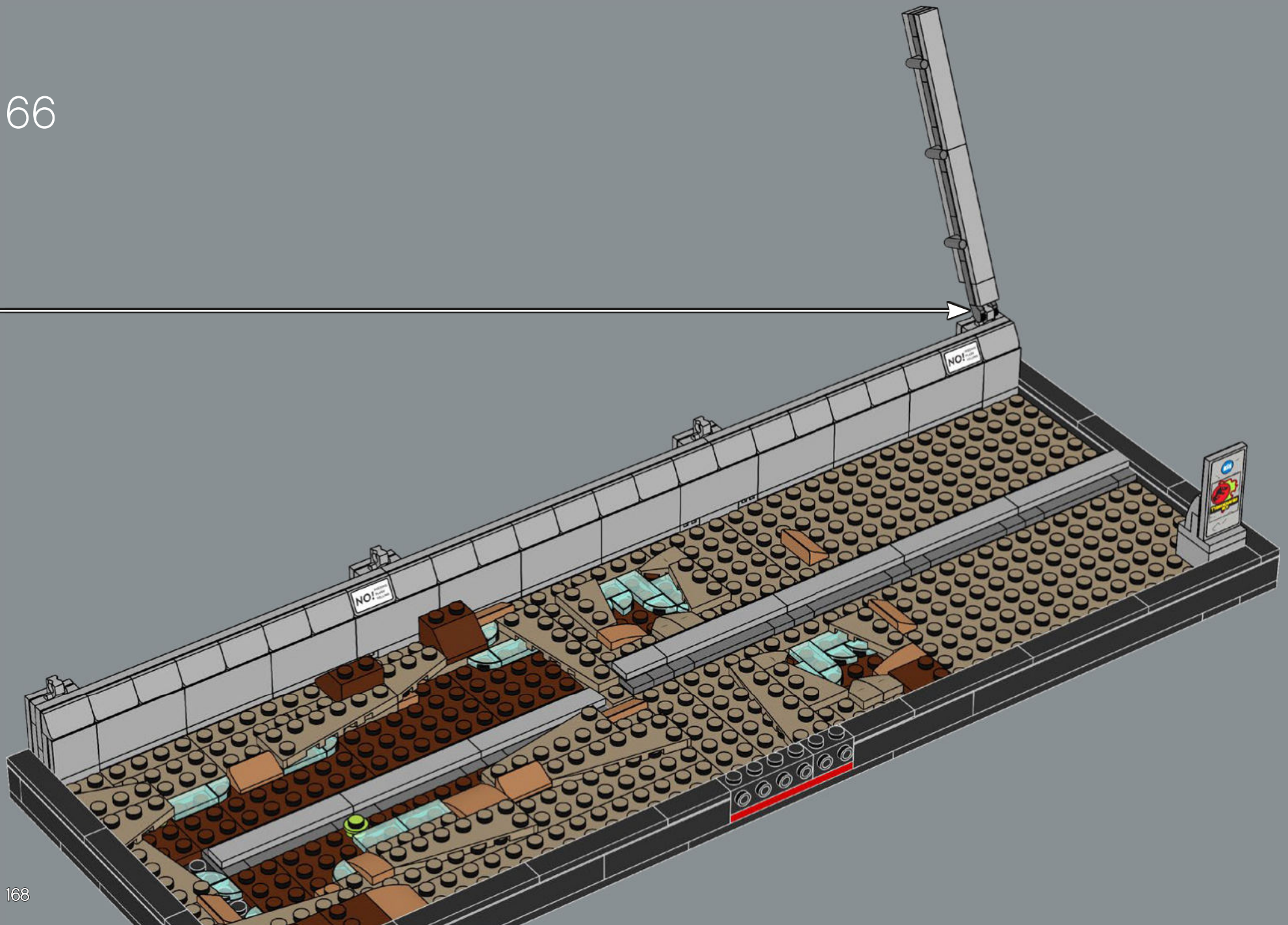

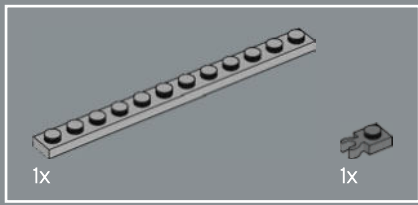

67

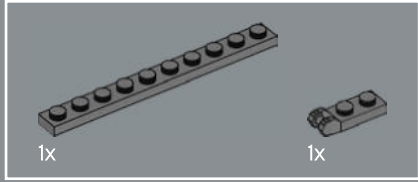
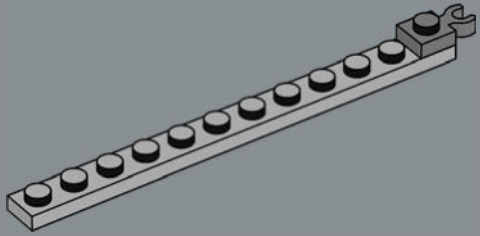

68

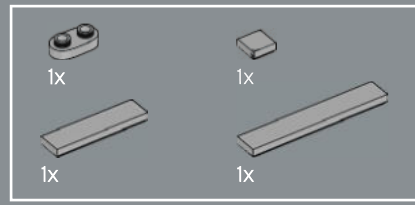
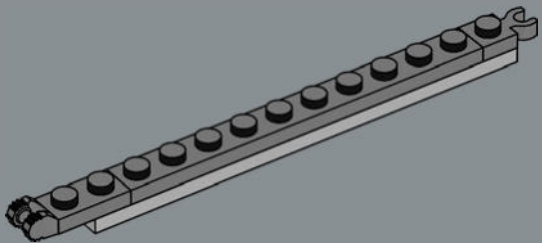

69

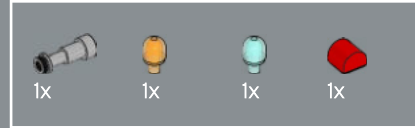
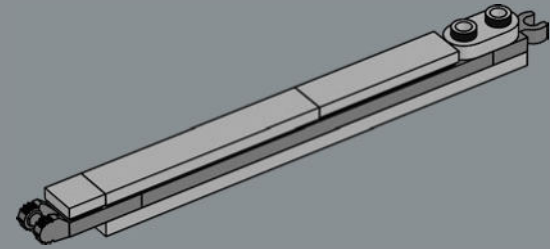

70

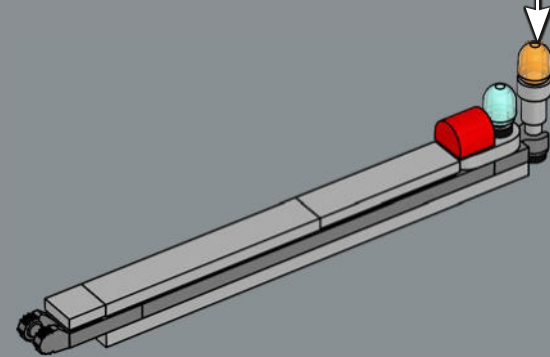

71

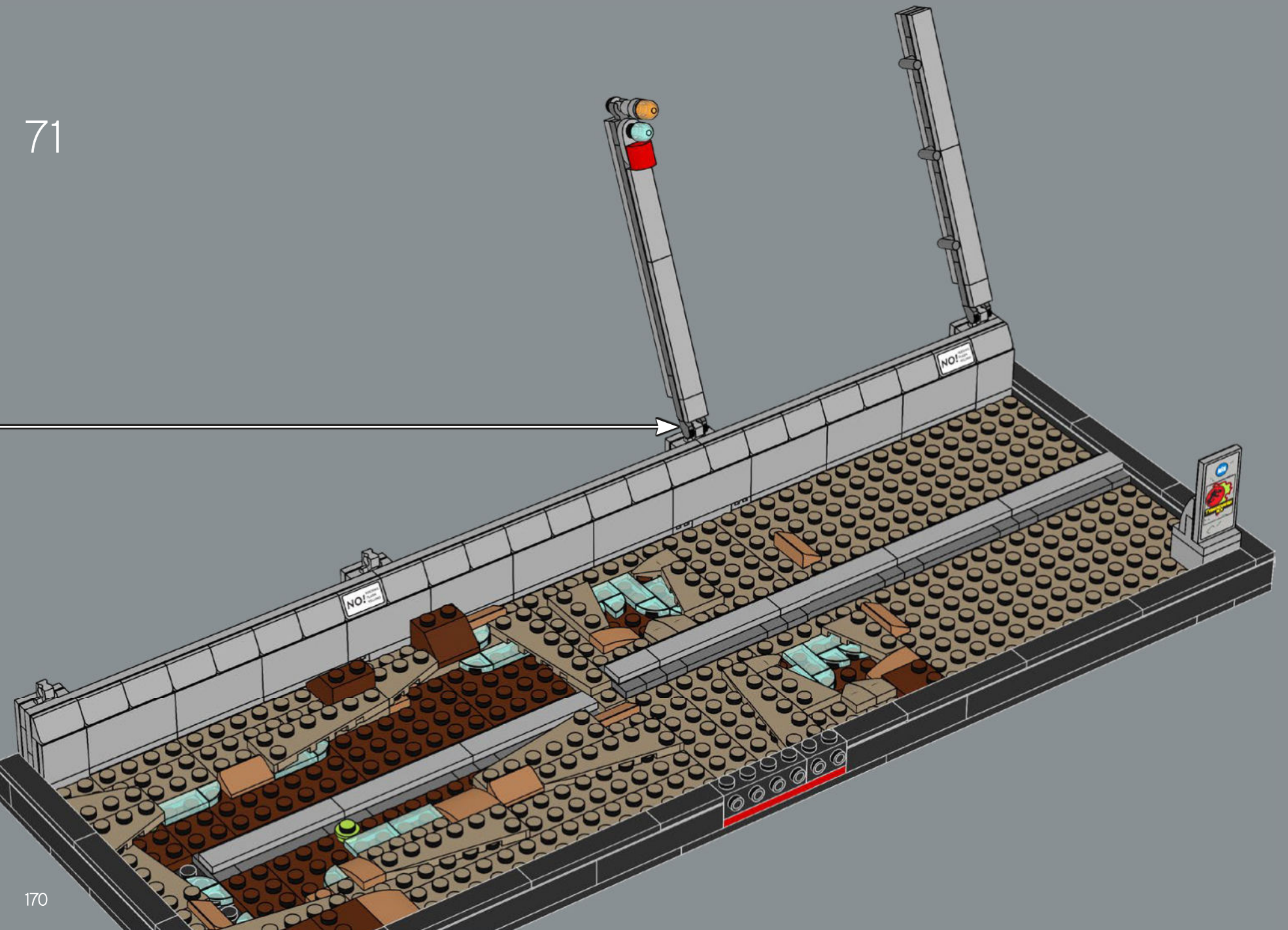

170

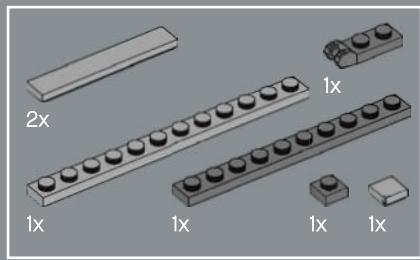

72

1

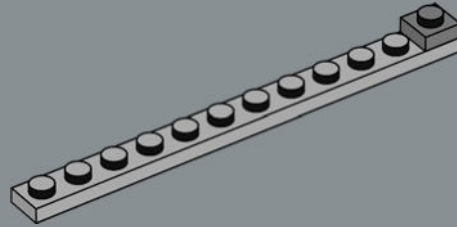

2

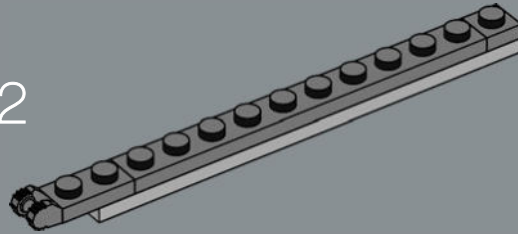

3

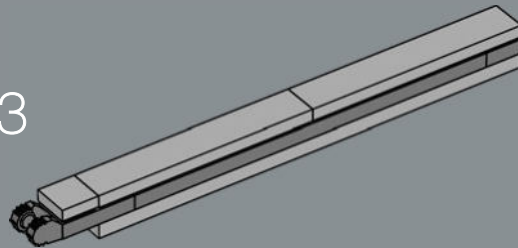

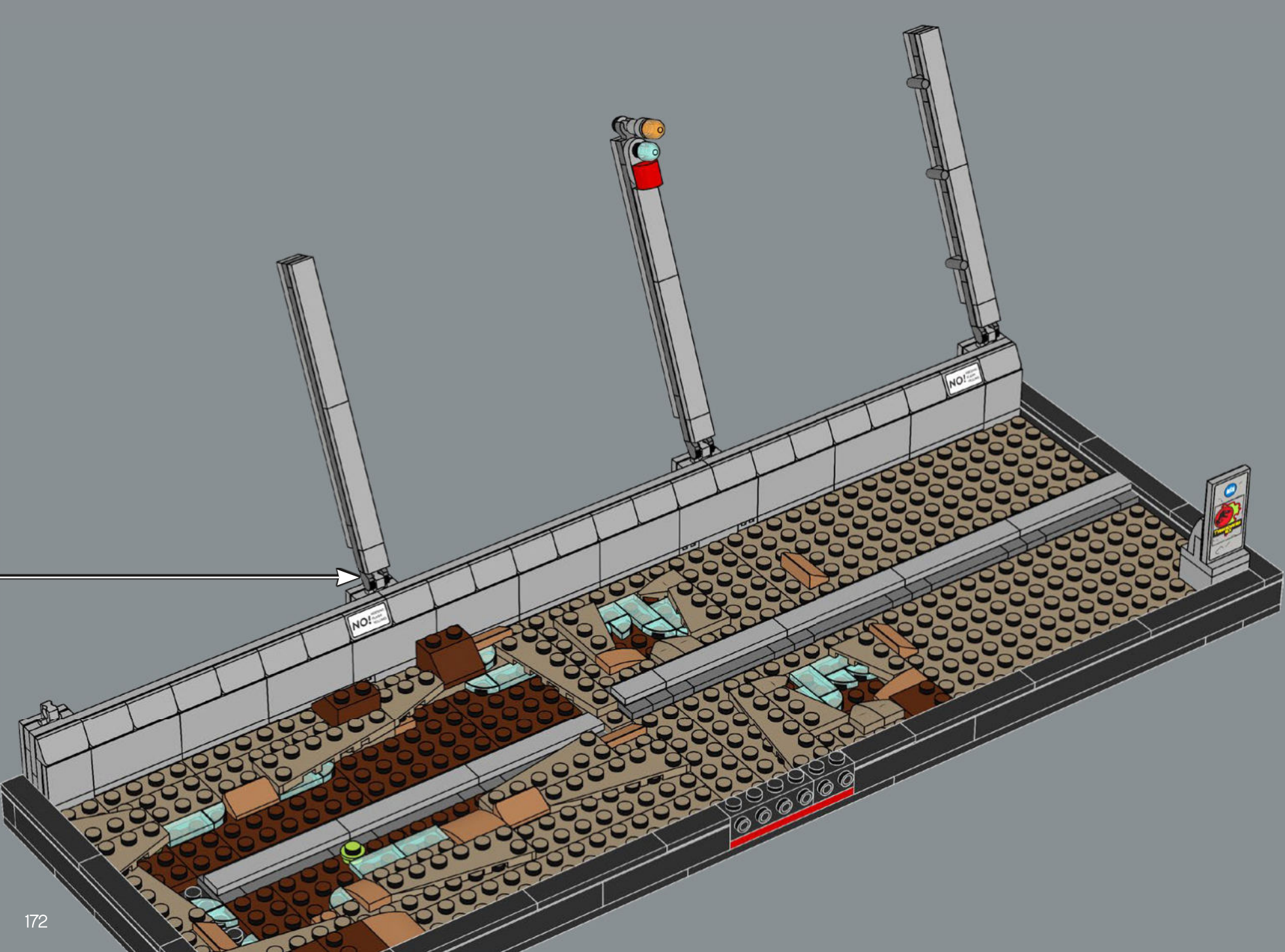

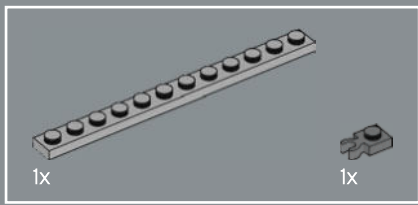

73

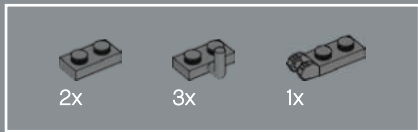
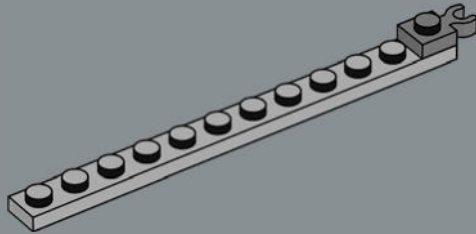

74

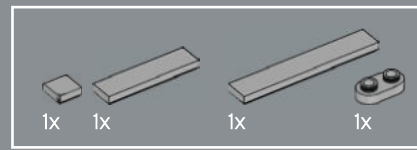
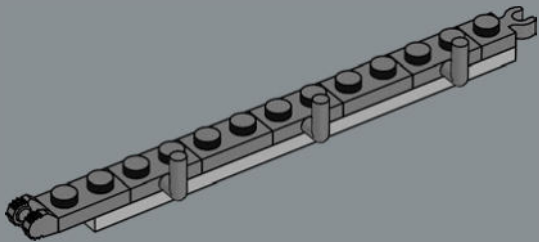

75

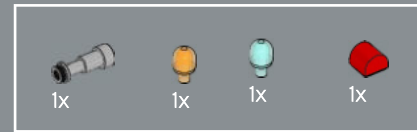
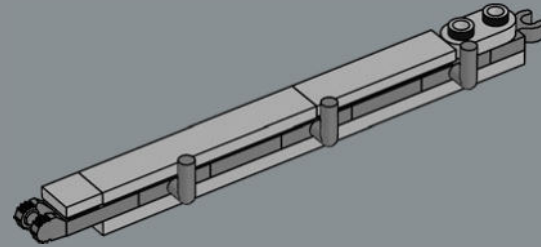

76

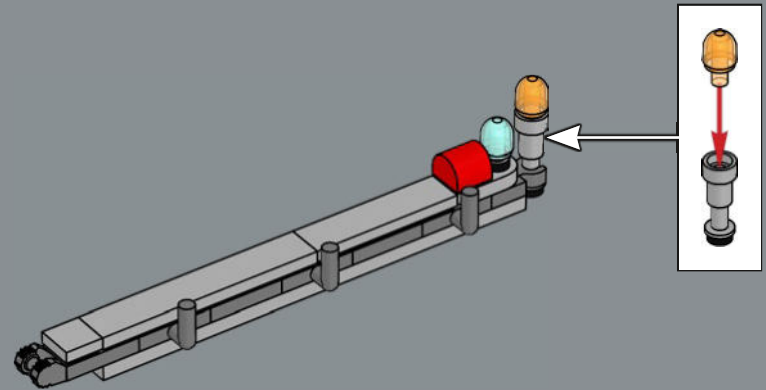

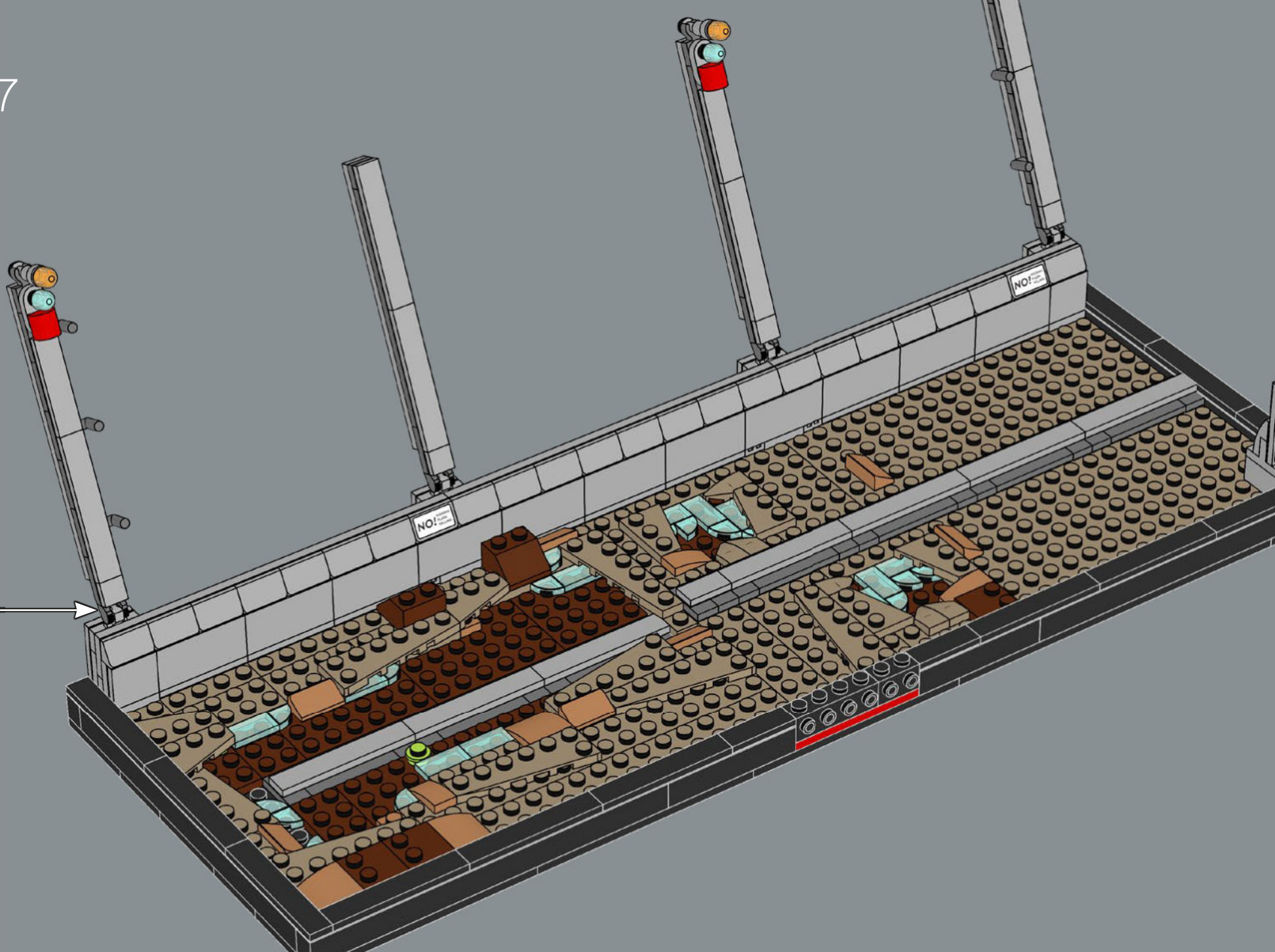

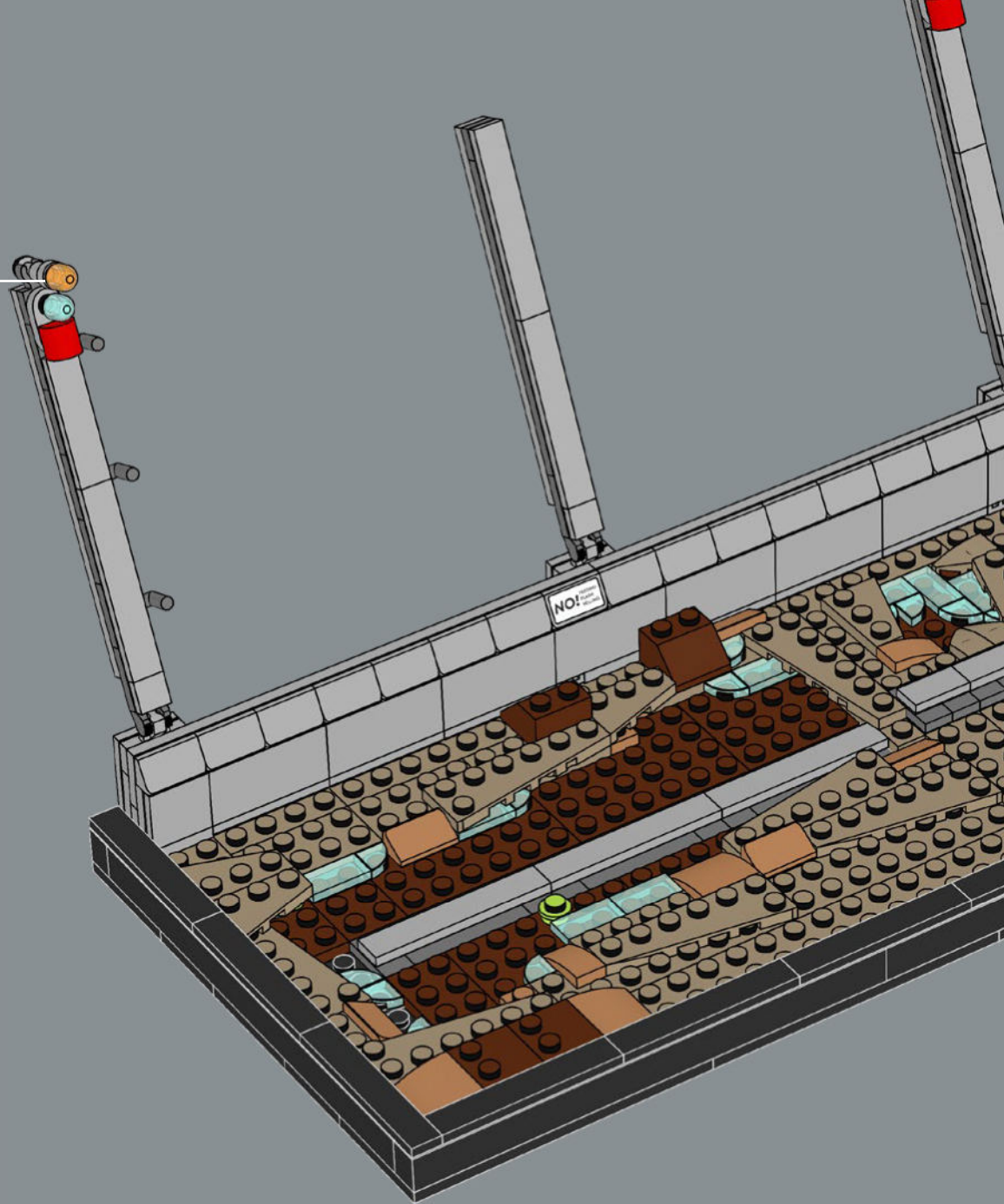
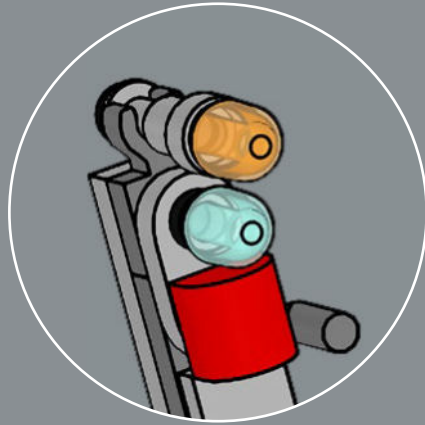

LIGHTS, DINOSAURS, ACTION...

If you happen to be climbing the fence (we don't recommend it) then beware the flashing blue light – it means the power is coming back online. 1 – 2 – 3 ... jump!

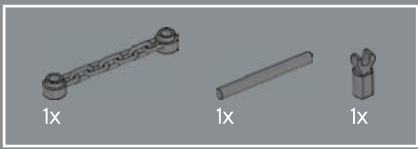

78

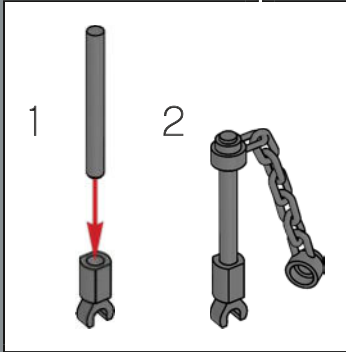
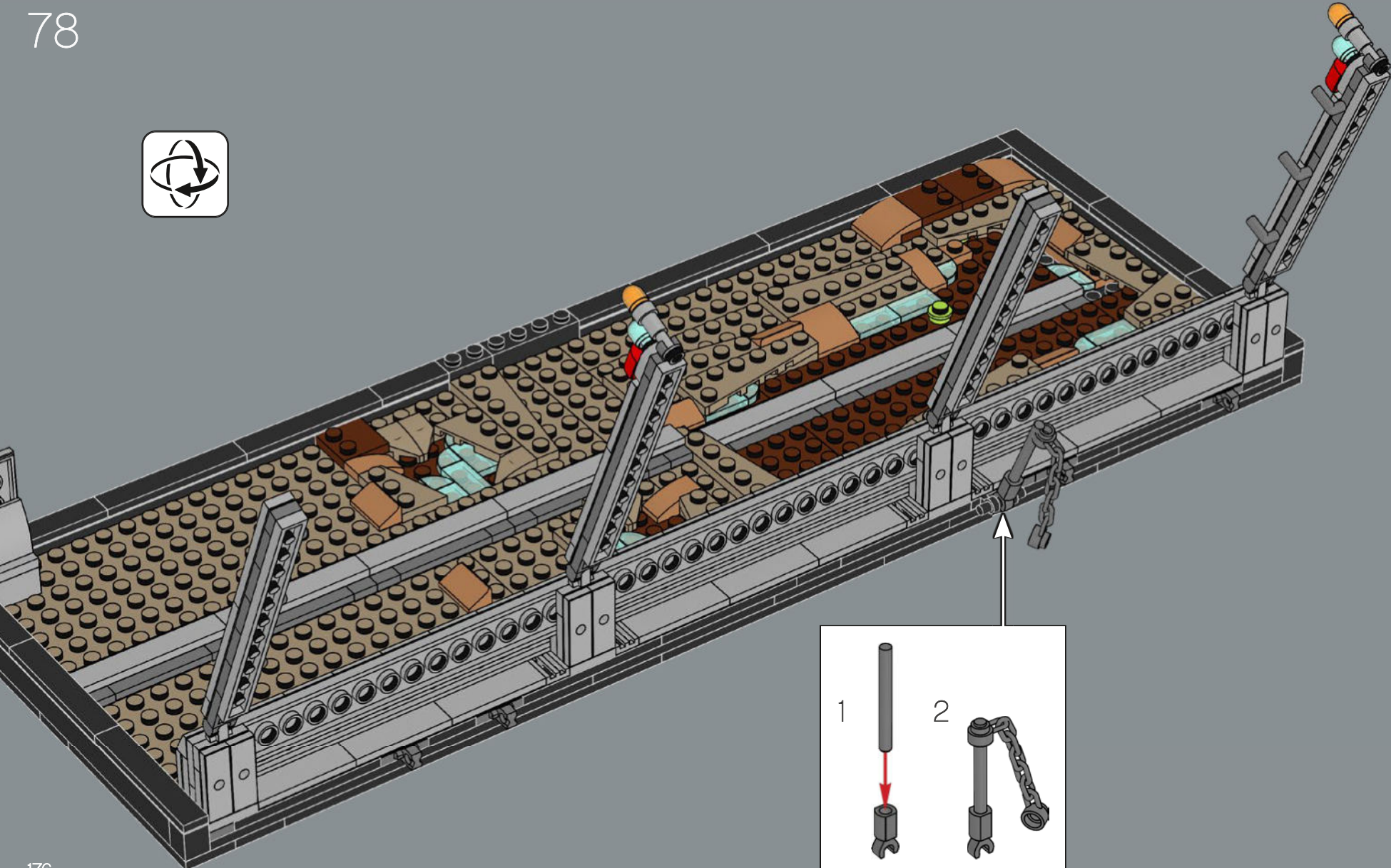



"WHERE'S THE GOAT?"

We could have sworn there was a goat here a moment ago?
Hmmm ... We're sure there's a logical and not terrifying reason for
its sudden disappearance which doesn't result in goat remains
landing on top of our car...

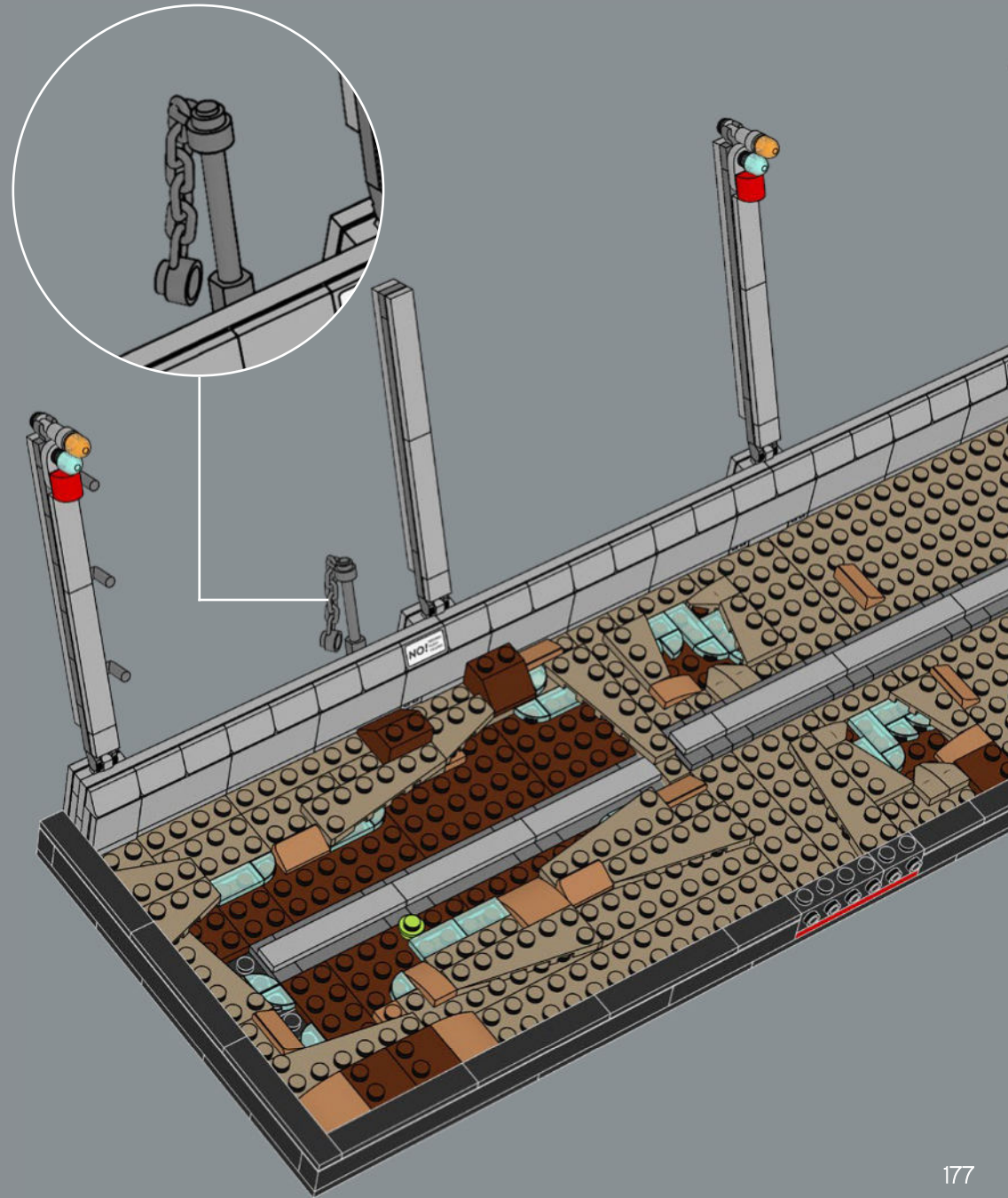

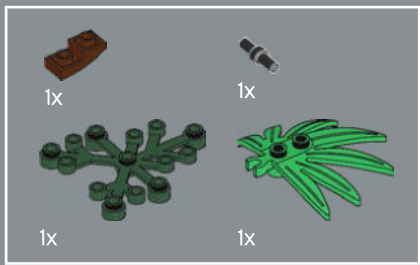

79

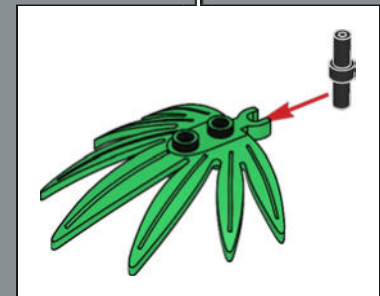
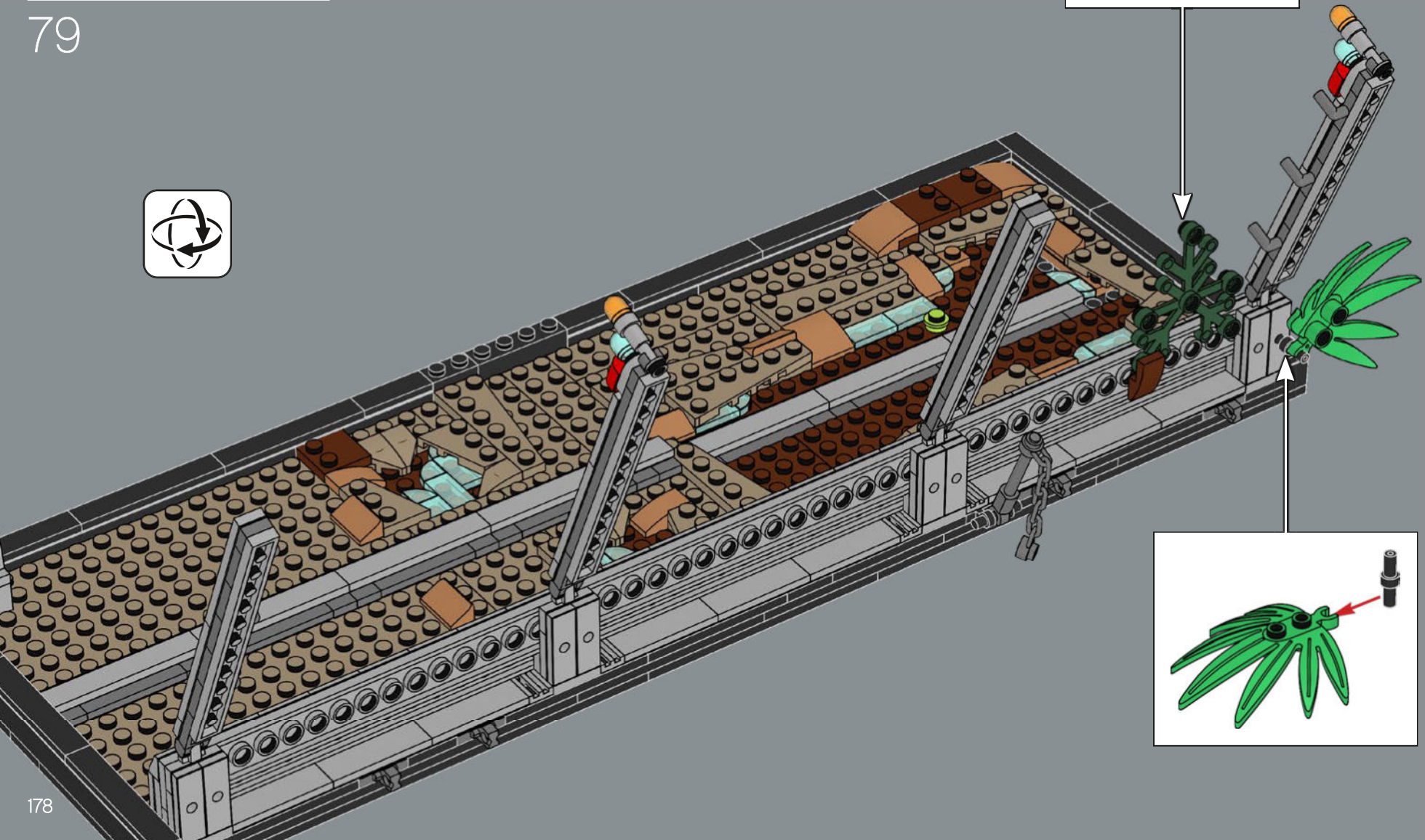
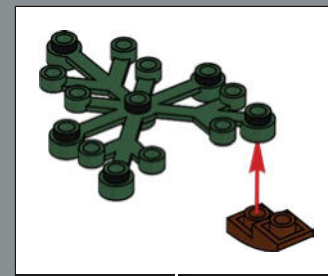

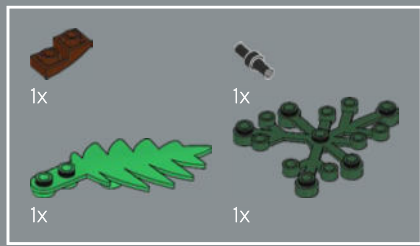

80

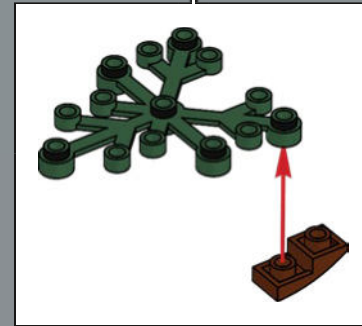
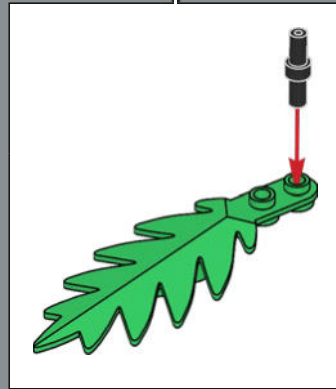
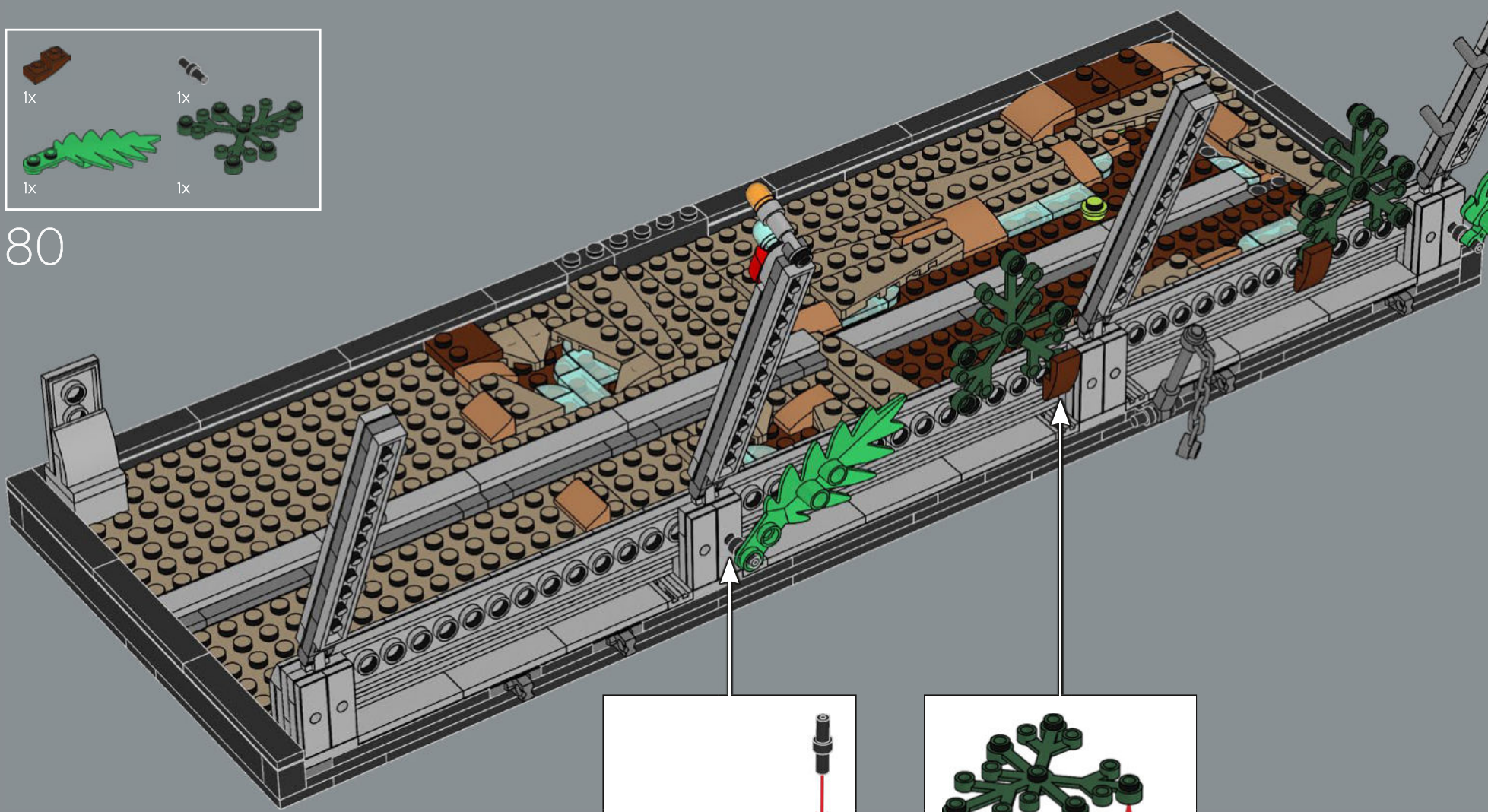

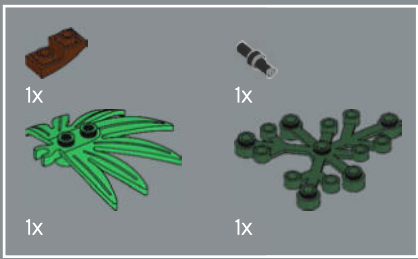

81

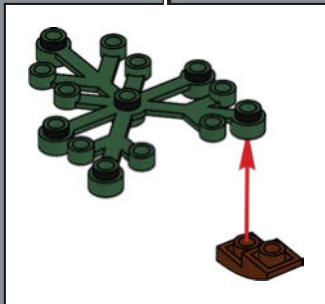
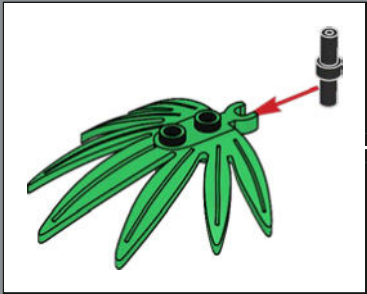
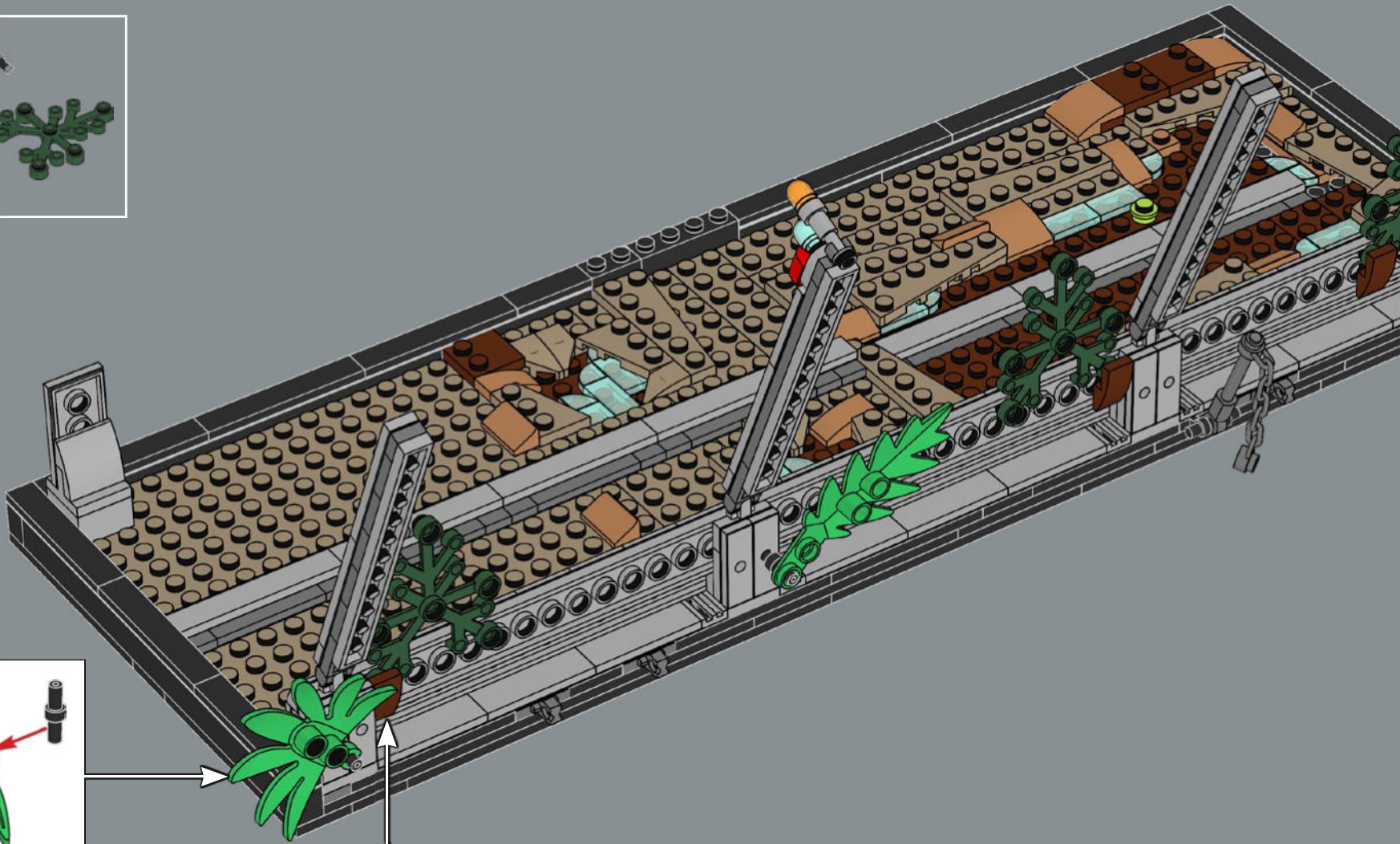

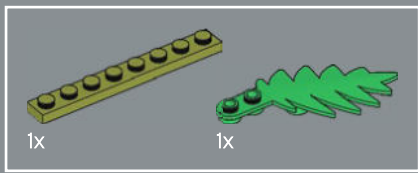

82

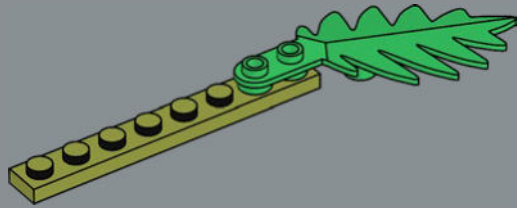

83

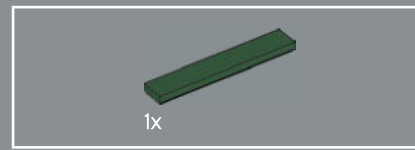
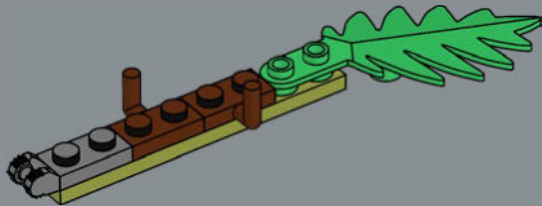

84

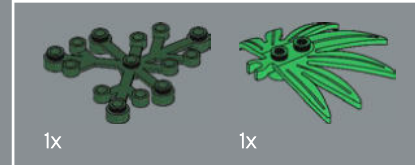
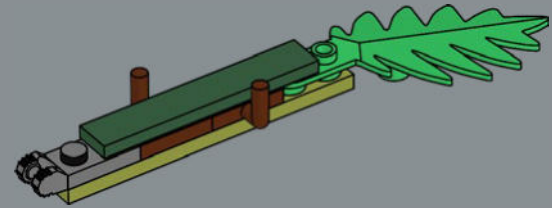

85

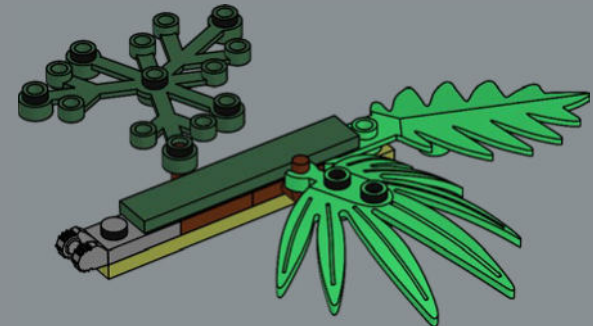

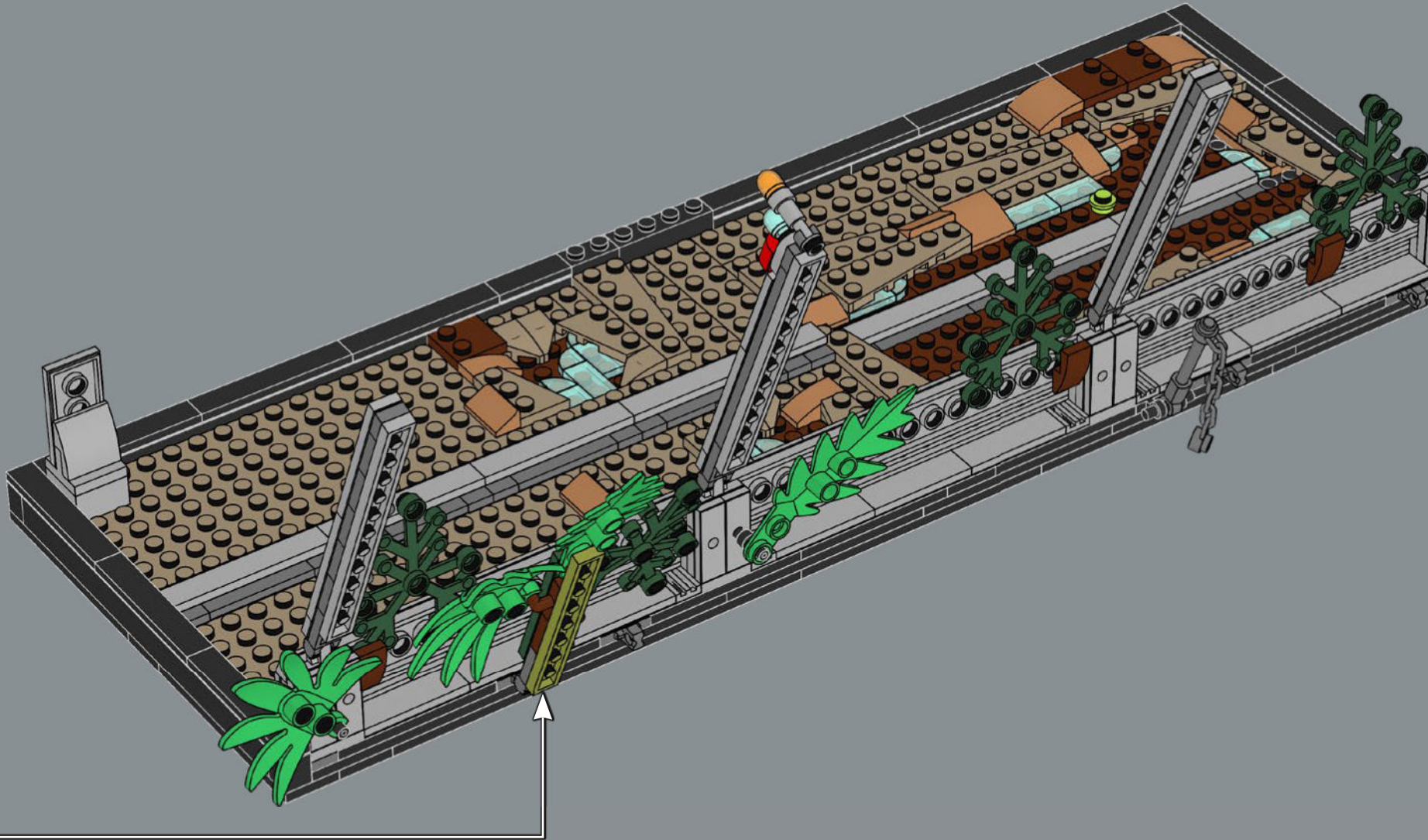

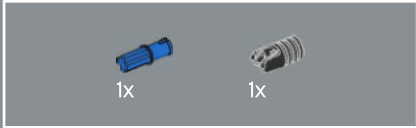

87

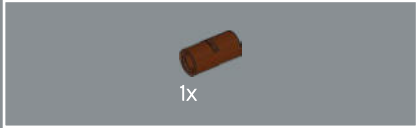

88

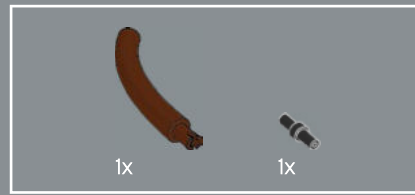

89



90

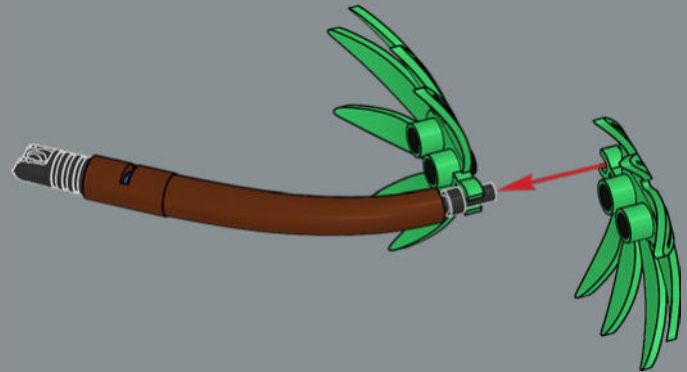

2x



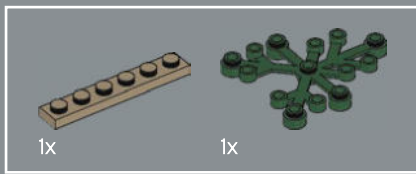

92

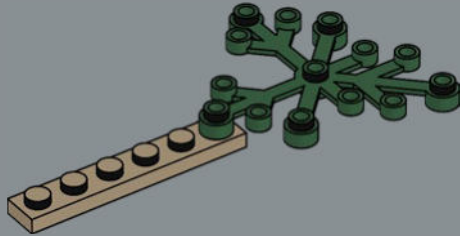

93

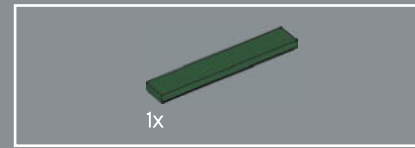
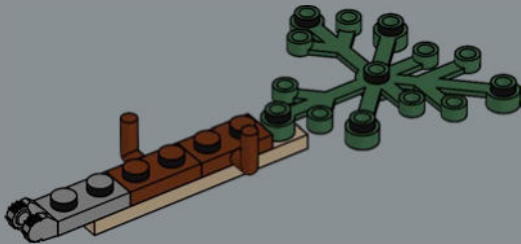

94

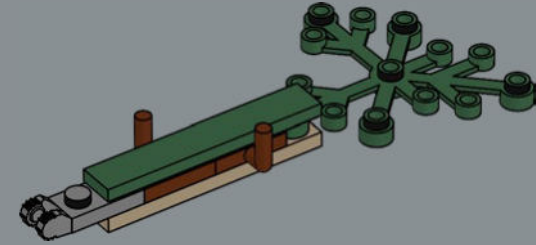

95

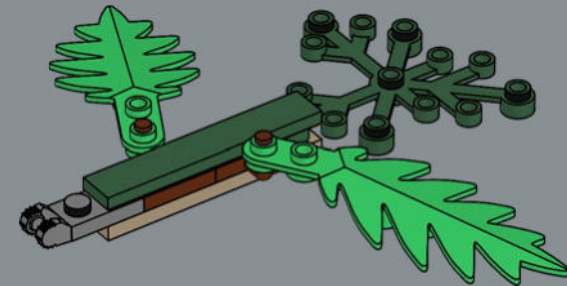

96

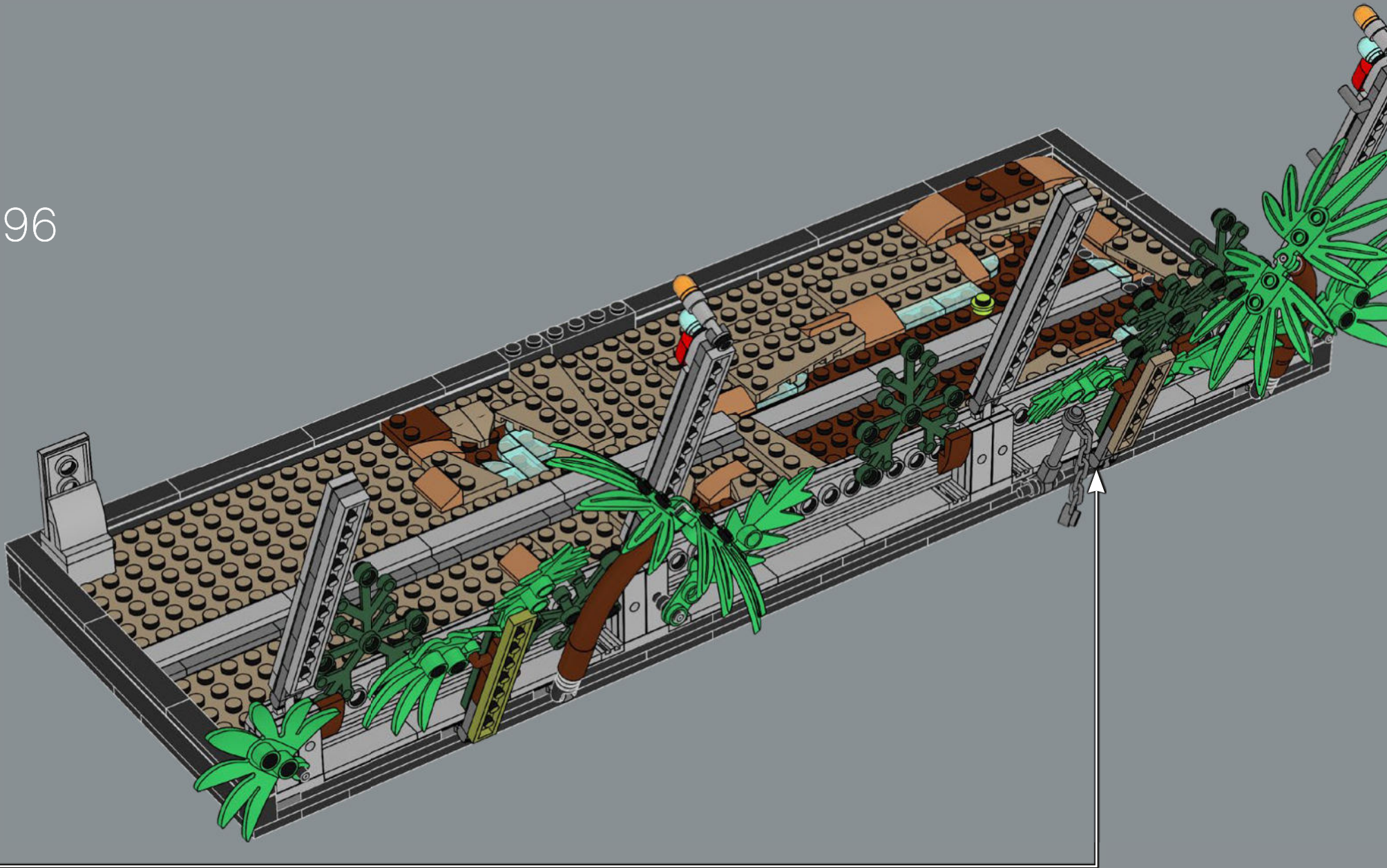

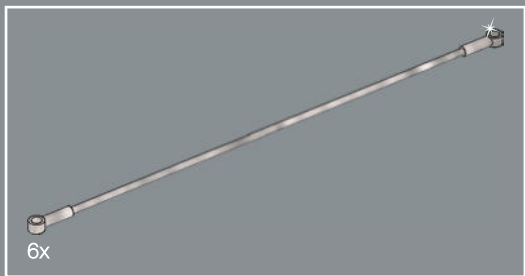

97





98

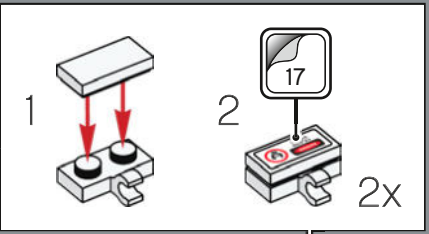



DANGER, HIGH VOLTAGE!

What a relief to know that there's a 10,000-volt fence between us and that marauding T. rex. Wait...what do you mean the power's been cut?!



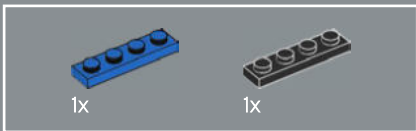
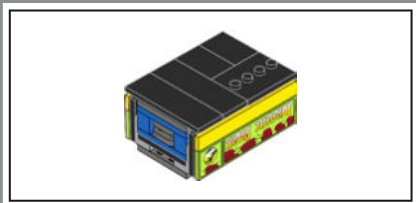
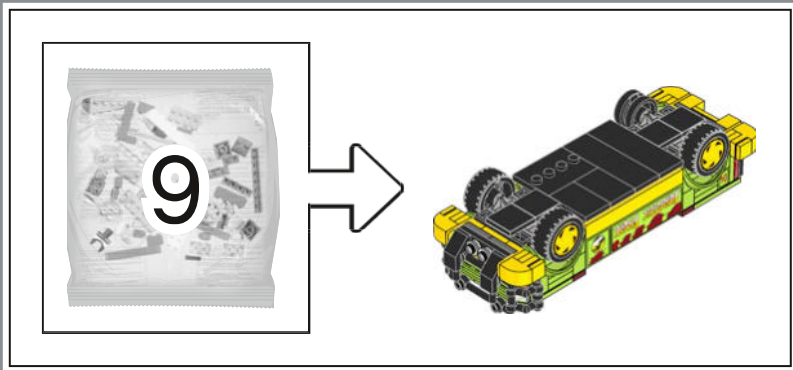

99

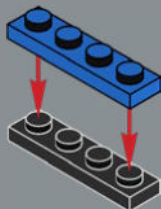

100

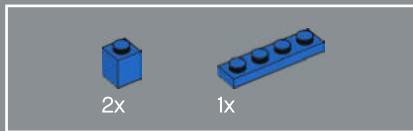
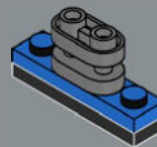

101

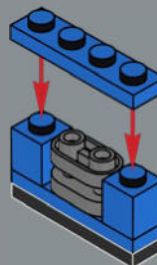

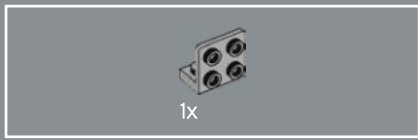

102

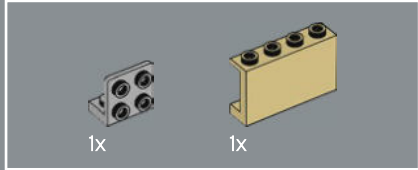
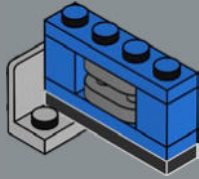

103

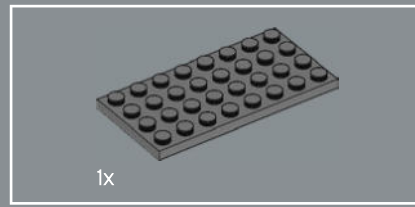
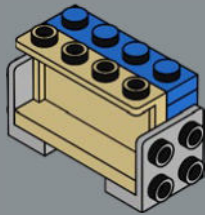

104

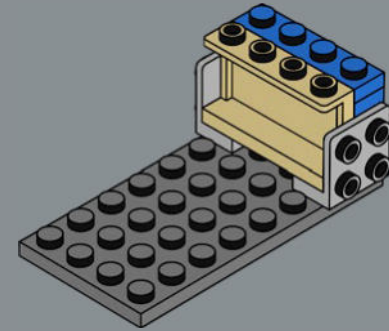

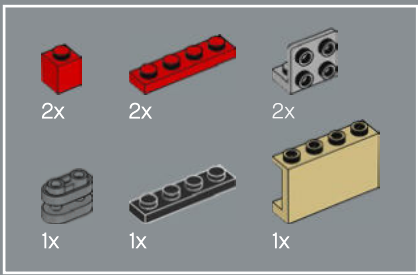

105

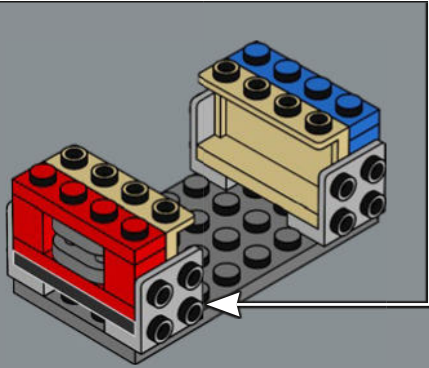
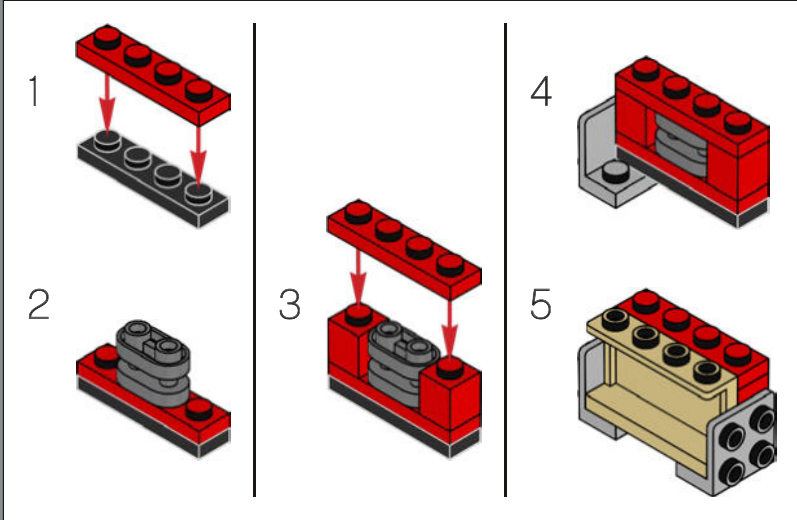

106

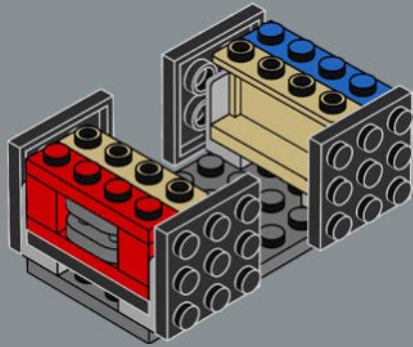

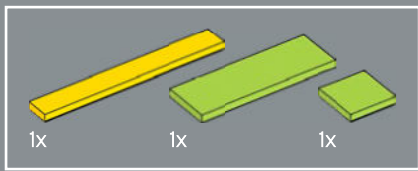

107

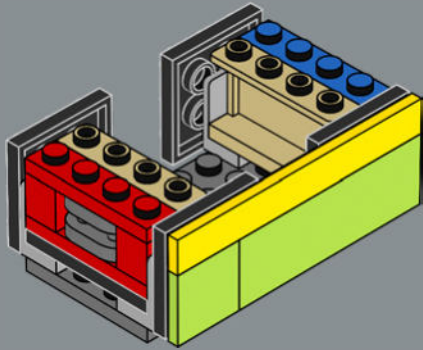

108

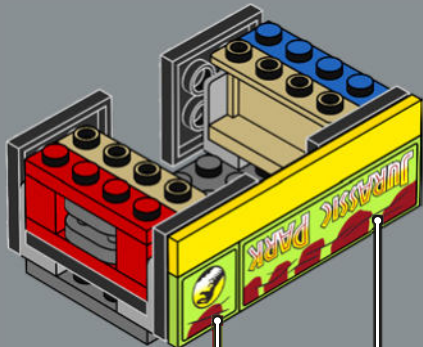

13



12

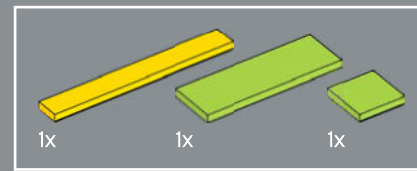

109

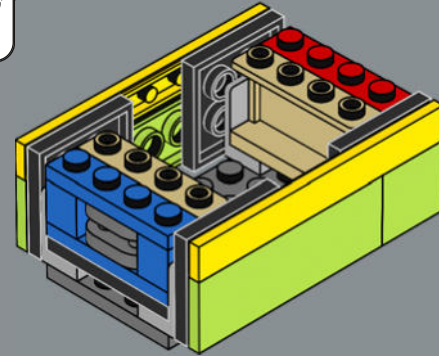

110

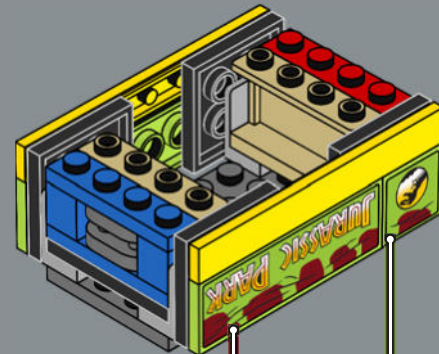

16



15

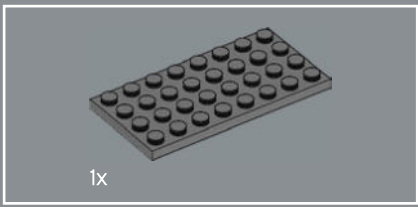

111

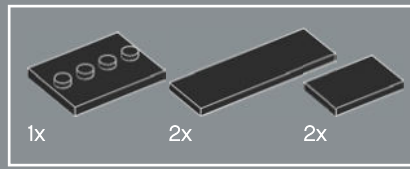
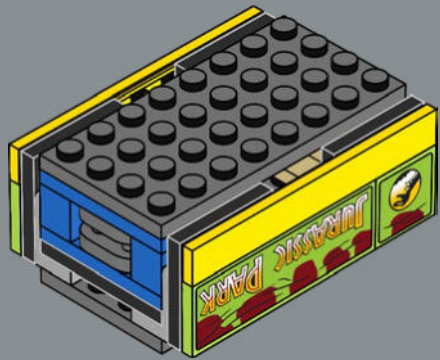

112

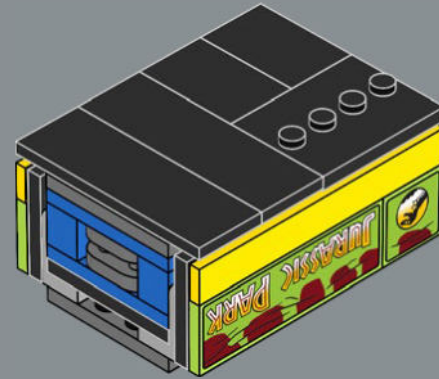

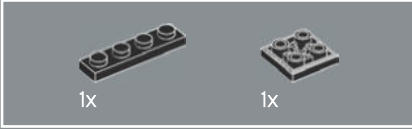
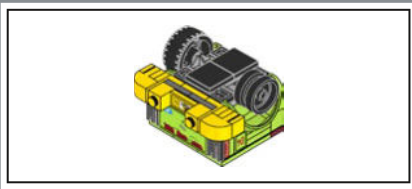

113

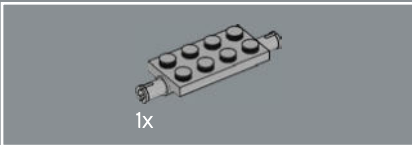
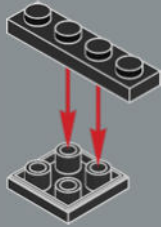

114

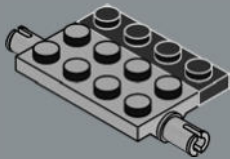

115

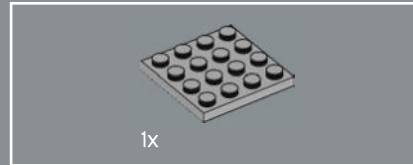
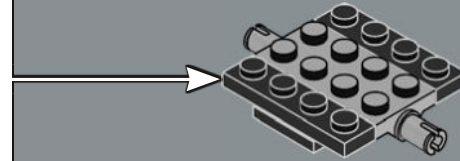
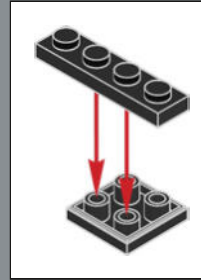

116

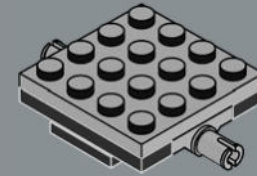

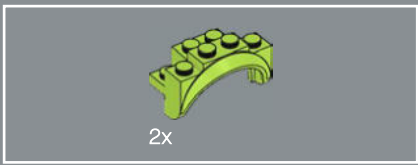

117

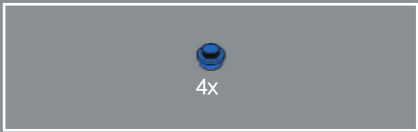
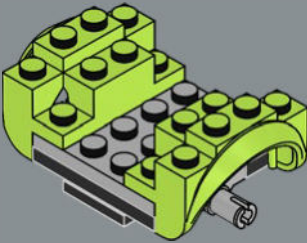

118

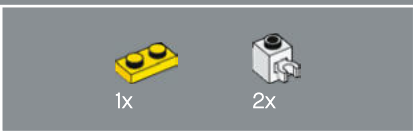
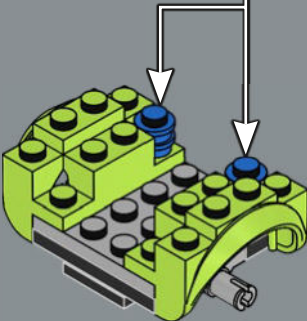
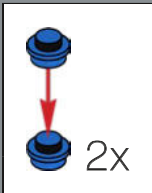

119

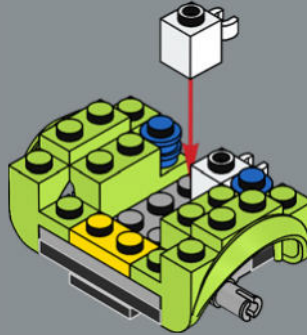

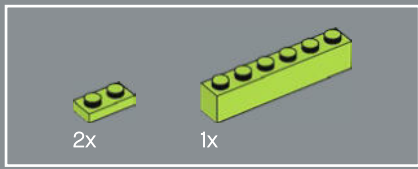

120

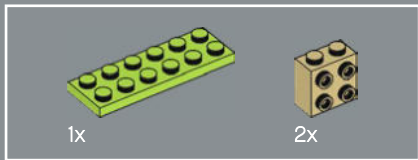
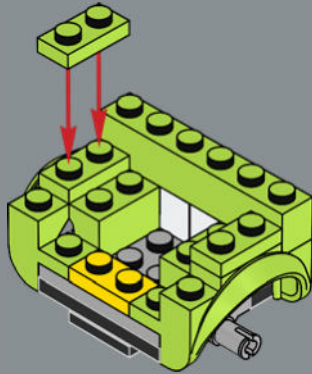

121

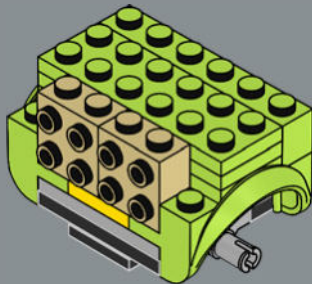

122

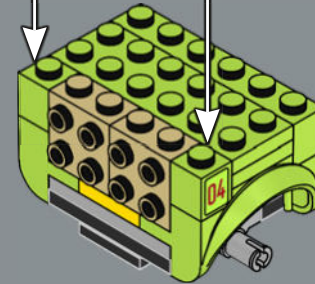
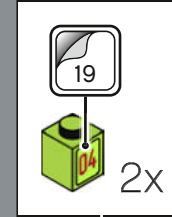

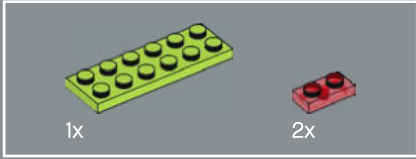
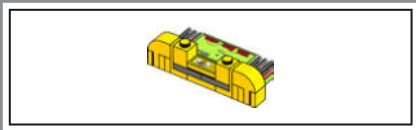

123

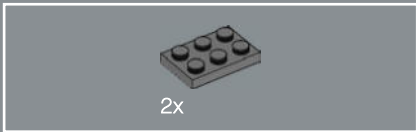
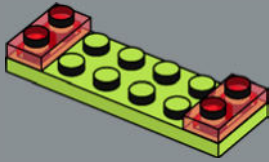

124

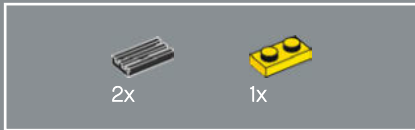
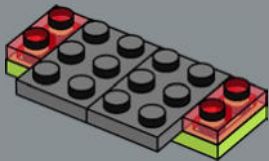

125

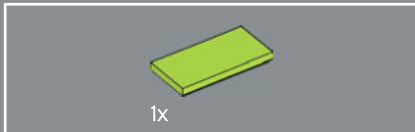
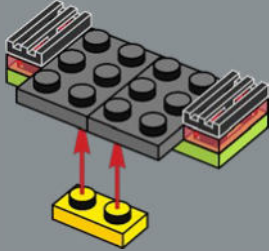

126

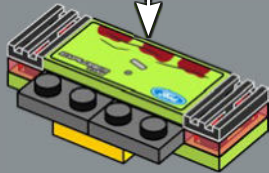
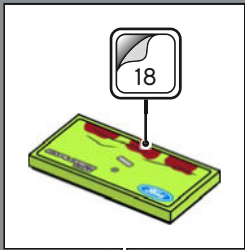

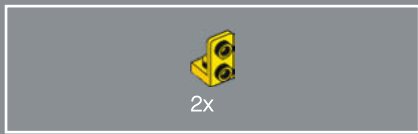

127

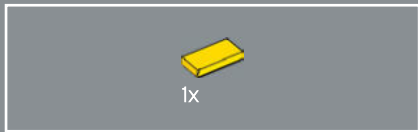
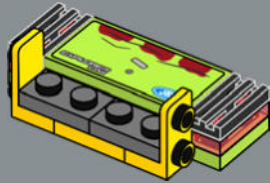

128

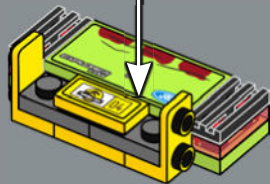

129

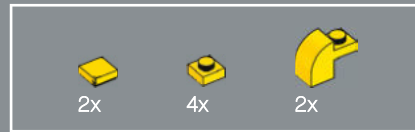
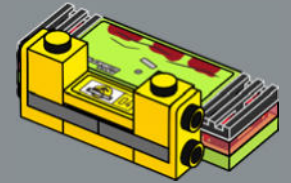

130

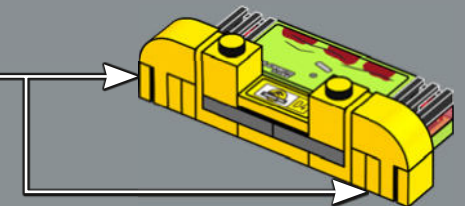
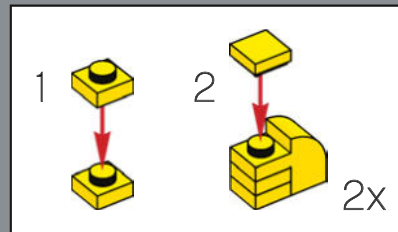

131

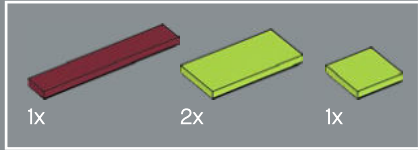
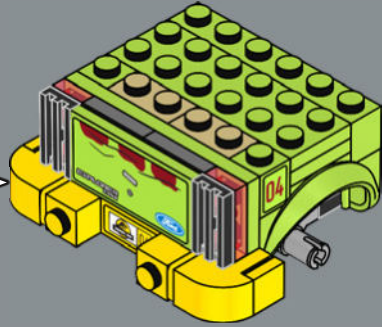

132

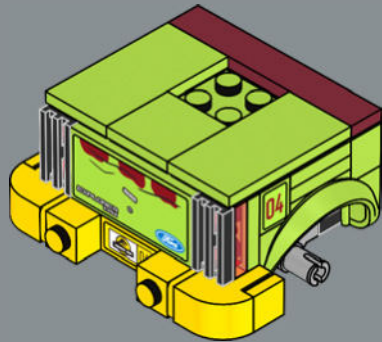

133

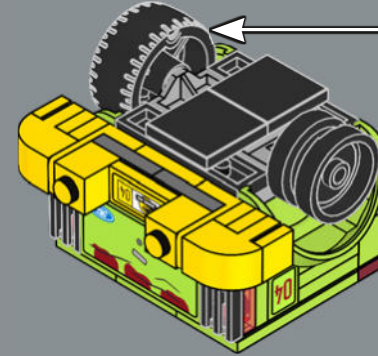

134

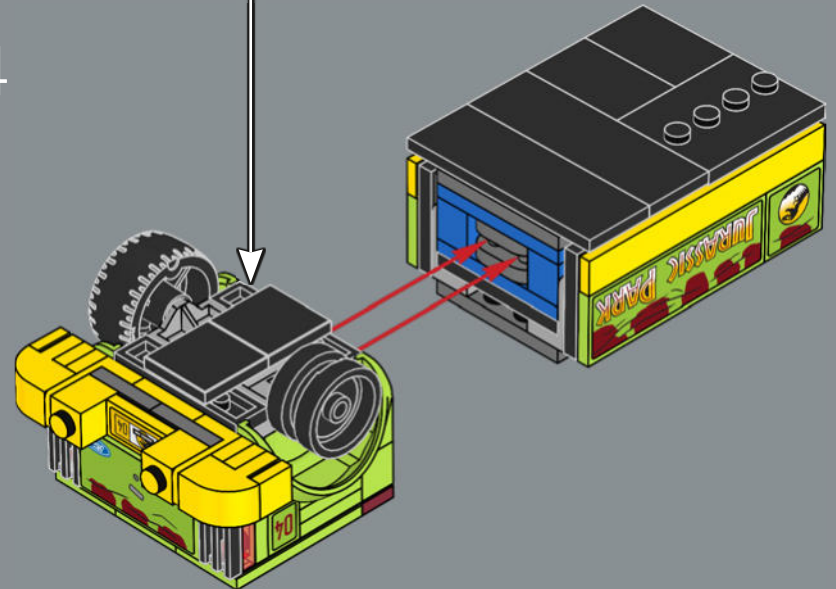

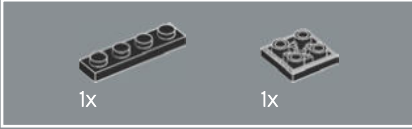
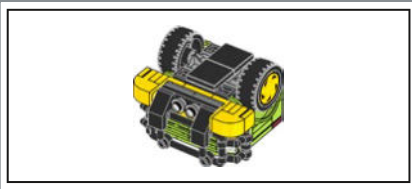

135

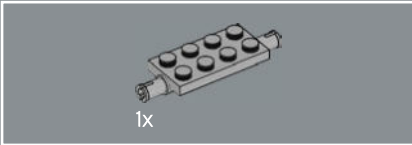
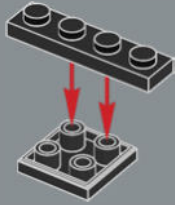

136

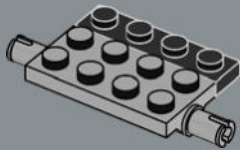

137

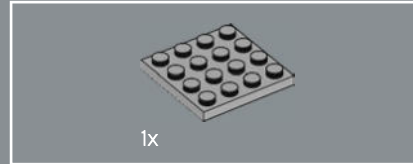
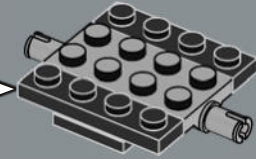
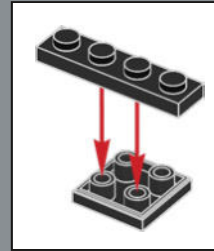

138

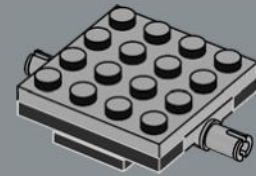



139

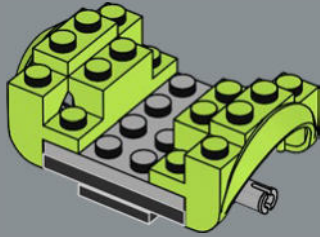

140

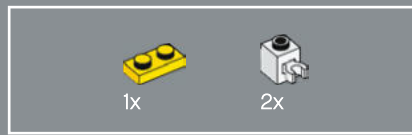
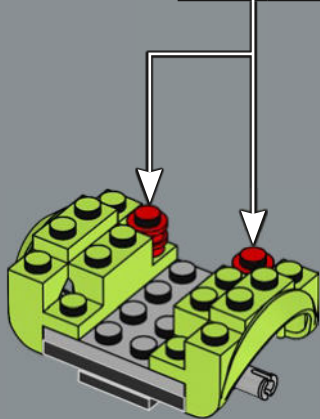
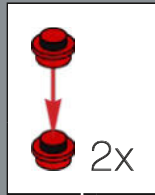

141

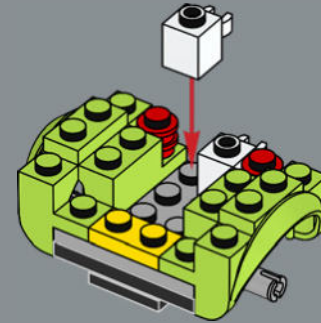

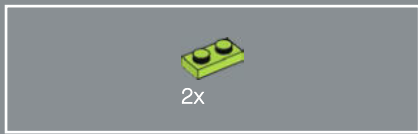

142

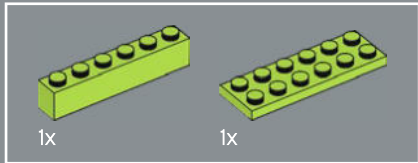
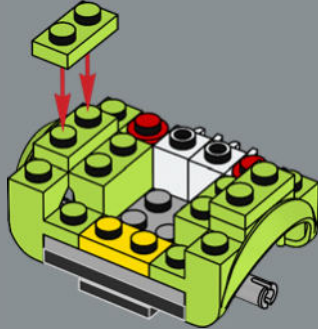

143

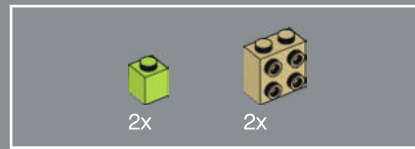
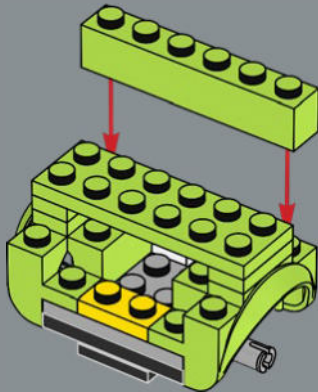

144

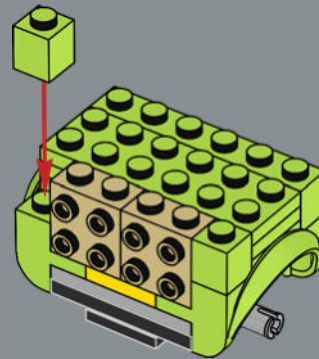

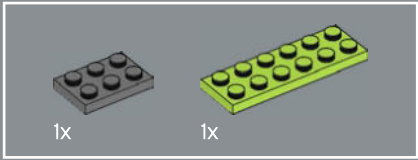
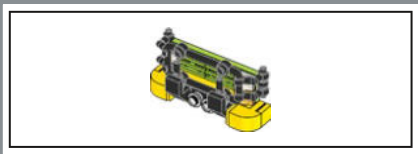

145

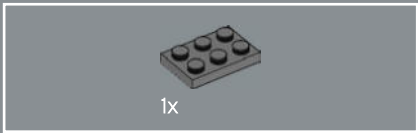
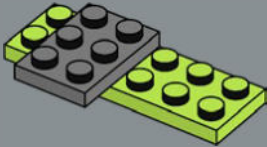

146

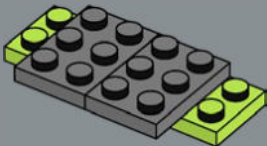

147

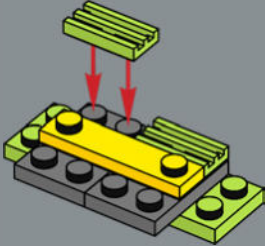

148

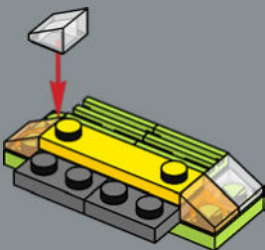

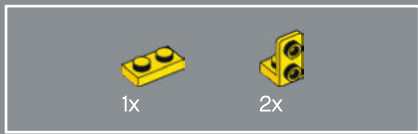

149

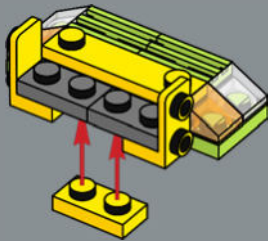

150

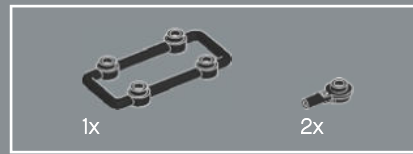
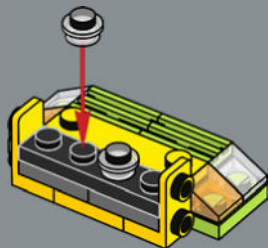

151

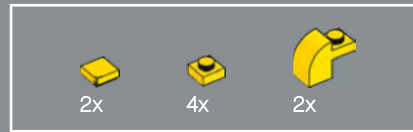
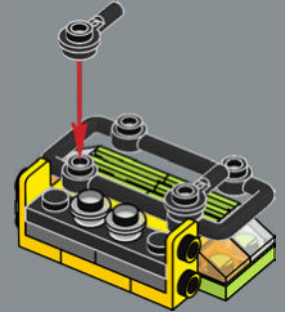

152

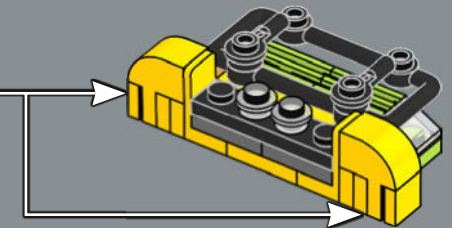
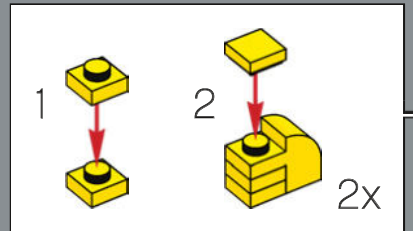



2x

153

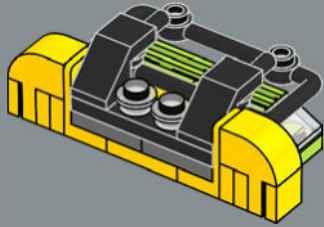

4x



2x

154

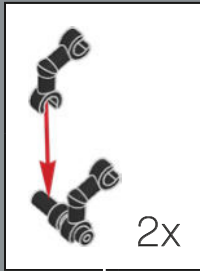

2x

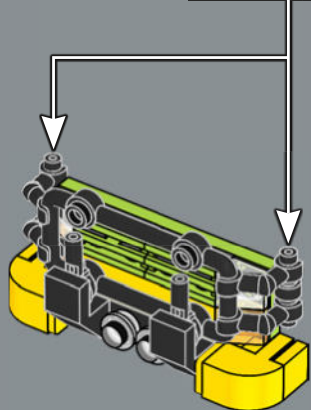

155

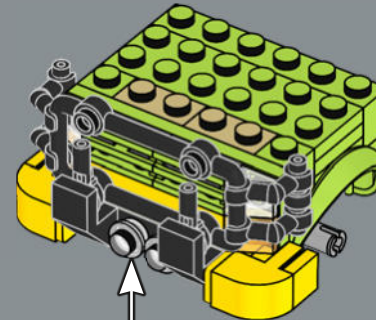

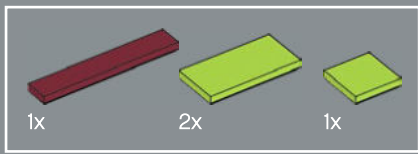

156

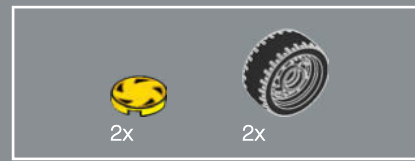
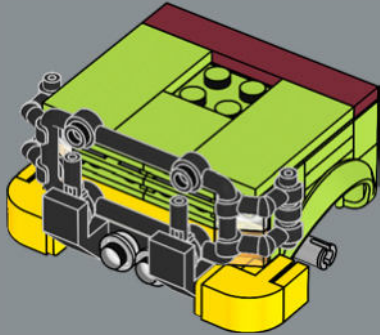

157

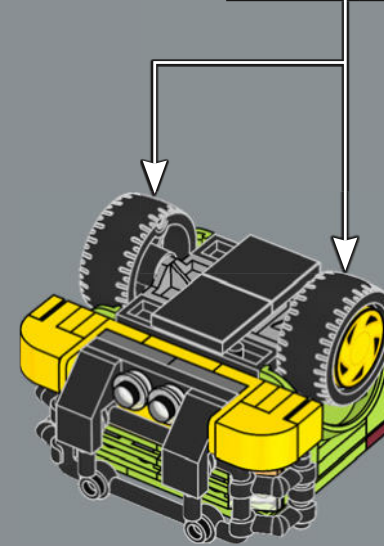
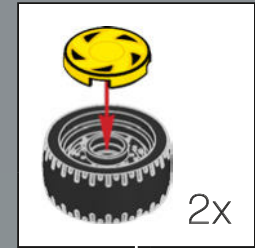

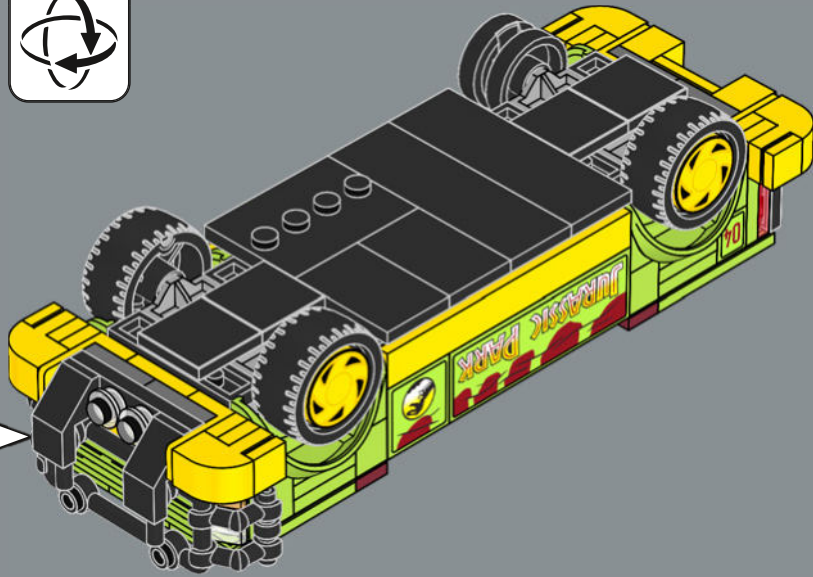

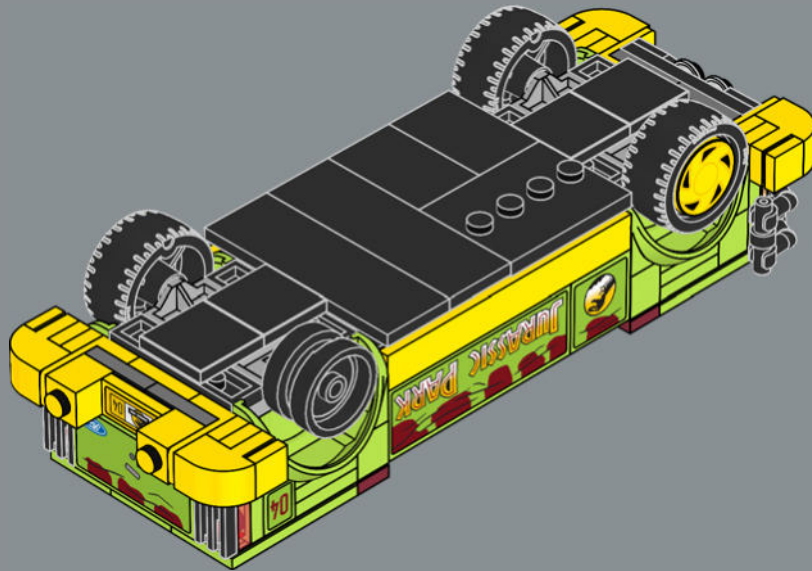

WHERE'S MY WHEEL?

Hmmm, we seem to be missing a tyre? Don't blame us, blame the hungry T. rex who mistook it for a tasty treat...





SEE YOU ON THE FLIP SIDE...

Just when you think your day can't get any worse, a T. rex flips your Ford Explorer onto its roof and stomps you into thick, oozing mud. It's going to take a miracle (or a brave man with a flare) to save you now...

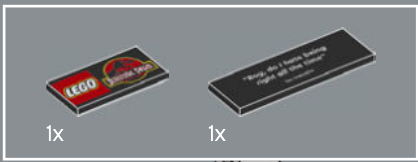

1x

1x

160





SARCASTIC PARK

Wherever a grave and serious situation unravelled (which was most of the time), Dr. Ian Malcolm could be relied upon for a well-timed sarcastic quip. Having forewarned park owner John Hammond about the dangers of keeping dinosaurs in captivity, he couldn't resist delivering this famous quote as the T. rex strode through the barrier and out of captivity...





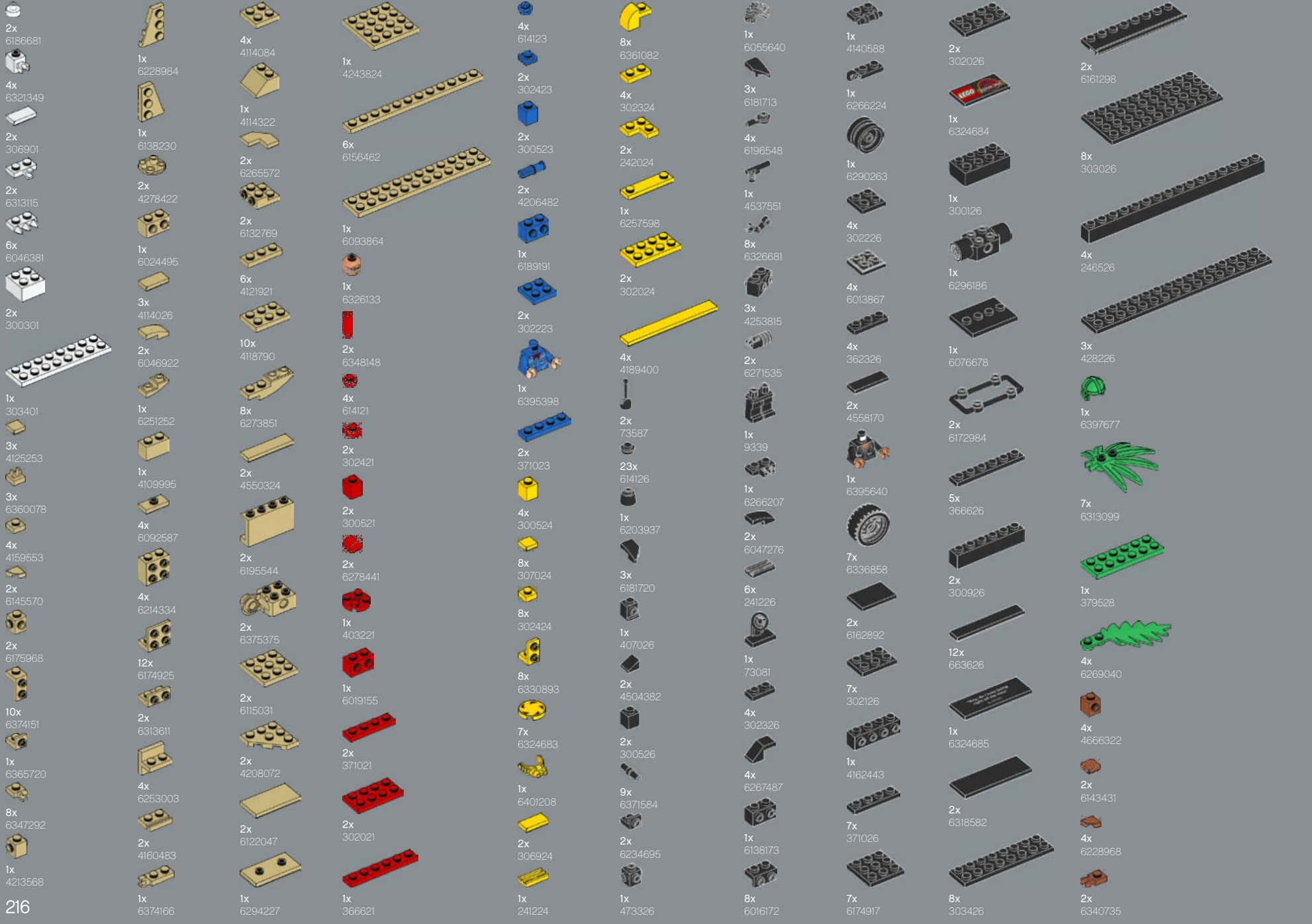

2x 6186681
 4x 6321349
 2x 306901
 2x 6313115
 6x 6046381
 2x 300301
 1x 303401
 3x 4125253
 3x 6360078
 4x 4159553
 2x 6145570
 2x 6175968
 10x 6374151
 1x 6365720
 8x 6347292
 1x 4213568

1x 6228984
 1x 6138230
 2x 4278422
 1x 6024495
 3x 4114026
 2x 6046922
 1x 6251252
 1x 4109995
 4x 6092587
 4x 6214334
 12x 6174925
 2x 6313611
 4x 6253003
 2x 4160483
 1x 6374166

4x 4114084
 1x 4114322
 2x 6265572
 2x 6132769
 6x 4121921
 10x 4118790
 8x 6273851
 2x 4550324
 2x 6195544
 2x 6375375
 2x 6115031
 2x 4208072
 2x 6122047
 1x 6294227

1x 4243824
 6x 6156462
 1x 6093864
 1x 6326133
 2x 6348148
 4x 614121
 2x 302421
 2x 300521
 2x 6278441
 1x 403221
 1x 6019155
 2x 371021
 2x 302021
 1x 366621

4x 614123
 2x 302423
 2x 300523
 2x 4206482
 1x 6189191
 2x 302223
 1x 6395398
 2x 371023
 4x 300524
 8x 307024
 8x 302424
 8x 6330893
 7x 6324683
 1x 6401208
 2x 306924
 1x 241224

8x 6361082
 4x 302324
 2x 242024
 1x 6257598
 2x 302024
 4x 4189400
 2x 73587
 23x 614126
 1x 6203937
 3x 6181720
 1x 407026
 2x 4504382
 2x 300526
 9x 6371584
 2x 6234695
 1x 473326

1x 6055640
 3x 6181713
 4x 6196548
 1x 4537551
 8x 6326681
 3x 4253815
 2x 6271535
 1x 9339
 1x 6266207
 2x 6047276
 6x 241226
 1x 73081
 4x 302326
 4x 6267487
 1x 6138173
 8x 6016172

1x 4140588
 1x 6266224
 1x 6290263
 4x 302226
 4x 6013867
 4x 362326
 2x 4558170
 1x 6395640
 7x 6336858
 2x 6162892
 7x 302126
 1x 4162443
 7x 371026
 7x 6174917

2x 302026
 1x 6324684
 1x 300126
 1x 6296186
 1x 6076678
 2x 6172984
 5x 366626
 2x 300926
 12x 663626
 1x 6324685
 2x 6318582
 8x 303426

2x 6161298
 8x 303026
 4x 246526
 3x 428226
 1x 6397677
 7x 6313099
 1x 379528
 4x 6269040
 4x 4666322
 2x 6143431
 4x 6228968
 2x 6340735

1x 6024495
 1x 6296186
 1x 6076678
 2x 6172984
 5x 366626
 2x 300926
 12x 663626
 1x 6324685
 2x 6318582
 8x 303426

1x 6024495
 1x 6296186
 1x 6076678
 2x 6172984
 5x 366626
 2x 300926
 12x 663626
 1x 6324685
 2x 6318582
 8x 303426

1x 6024495
 1x 6296186
 1x 6076678
 2x 6172984
 5x 366626
 2x 300926
 12x 663626
 1x 6324685
 2x 6318582
 8x 303426

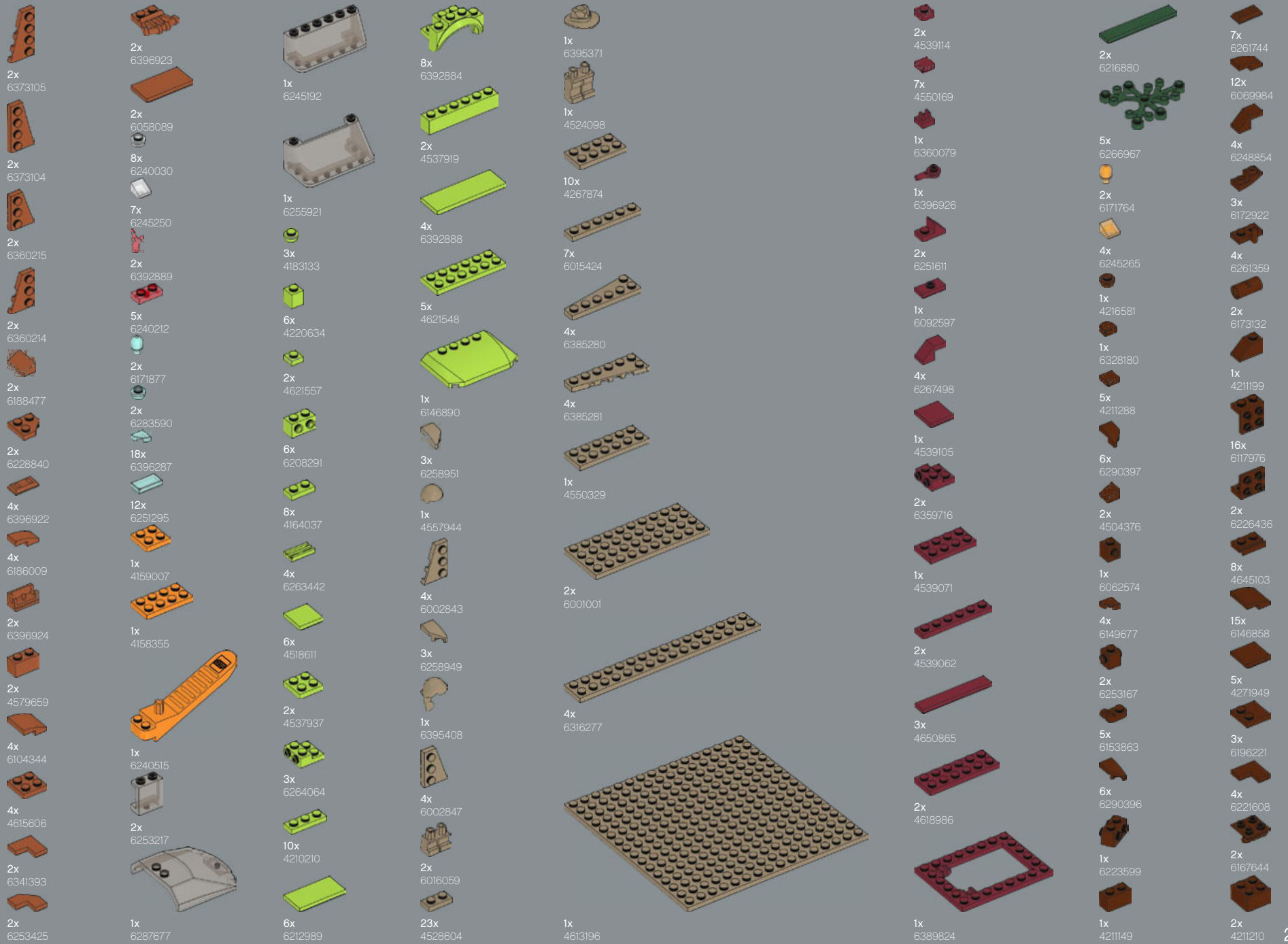



- 2x 6392880
- 4x 4211247
- 2x 4585337
- 1x 6096701
- 8x 4217848
- 3x 4211214
- 3x 4211202
- 1x 6146301
- 2x 6326087
- 1x 4211189
- 9x 4211190
- 2x 4658005
- 2x 6153594
- 12x 4211186
- 4x 4211415
- 2x 6248890
- 24x 4568637
- 6x 6043656
- 4x 6266251
- 4x 4211350
- 1x 4211414
- 2x 4657366
- 8x 4654582
- 4x 4654580
- 5x 6258820
- 4x 4211397
- 2x 4211413
- 1x 6185676
- 2x 4211387
- 3x 6043639
- 8x 6251044
- 2x 4211356
- 21x 4560183
- 4x 4211572
- 13x 4211549
- 2x 4243797
- 4x 4211425
- 4x 4514846
- 6x 4211486
- 1x 6336970
- 4x 4210719
- 2x 6390673
- 2x 6296892
- 4x 6039479
- 4x 6266248
- 16x 6092572
- 6x 6261355
- 4x 4211063
- 2x 4522784
- 5x 6123814
- 2x 4218696
- 6x 6267047
- 1x 6378143
- 4x 4211043
- 7x 4560184
- 1x 6311445
- 2x 4257526
- 2x 4211061
- 1x 4211122
- 1x 6395537
- 1x 6133726
- 1x 6132918
- 1x 4654128
- 1x 6058222
- 1x 6326126
- 1x 6326123
- 1x 6326121
- 2x 6215606
- 1x 6368591
- 4x 6380634
- 11x 6218358
- 3x 6356566
- 3x 6312473
- 1x 6177535
- 1x 6167699
- 2x 6334099
- 4x 6167700
- 2x 6175943
- 6x 6210590
- 1x 6395510
- 1x 6278034



Customer Service
Kundenservice
Service Consommateurs
Servicio Al Consumidor

LEGO.com/service or dial

00800 5346 5555 : 

1-800-422-5346 : 



FEEDBACK AND WIN



FEEDBACK AND WIN

Your feedback will help shape the future development of this product series.

Please visit:

FEEDBACK UND GEWINNEN

Dein Feedback trägt zur Weiterentwicklung dieser Produktreihe bei.

Geh auf:

COMMENTEZ ET GAGNEZ

Vos commentaires nous aideront à concevoir les futurs produits de cette gamme.

Rendez-vous sur :

COMENTA Y GANA

Tu opinión nos ayudará a dar forma al desarrollo de esta serie de productos en el futuro.

Visita:

反馈有奖

您的反馈将有助于我们在今后改进本系列产品。

请访问：

[LEGO.com/productfeedback](https://www.lego.com/productfeedback)

By completing, you will automatically enter a drawing to win a LEGO® set.

Terms & Conditions apply.

Durch Ausfüllen nimmst du automatisch an der Verlosung eines LEGO® Preises teil.

Es gelten die Teilnahmebedingungen.

En envoyant vos commentaires, vous serez automatiquement inscrit(e) à un tirage au sort qui vous permettra de remporter un prix LEGO®.

Offre soumise à conditions.

Al contestar, participarás automáticamente en el sorteo y podrás ganar un set LEGO®.

Sujeto a Términos y Condiciones.

完成我们的反馈调查，即可自动进入抽奖环节，赢取乐高®套装。

适用《条款和条件》。

LEGO and the LEGO logo are trademarks of the LEGO Group. ©2022 The LEGO Group.

© Universal City Studios LLC and Amblin Entertainment, Inc. All Rights Reserved.

Ford Motor Company Trademarks and Trade Dress used under license to the LEGO Group.

